

### 1) Introduction

The Appello tone and speech annunciation sounder has three different styles in DC.

- D105AX Sounder
- DL105AXX Sounder Beacon (Xenon)
- DL105AXH Sounder Beacon (LED)

These Sounder units share a common set of functions:-

- 4 stages, each stage can record up to 30 seconds of CD quality audio.
- Facility to record via an on board microphone or a line in input.
- The recorded message can be played back proceeded either with or without the choice of one of forty five tones.

The Beacon functions are either:-

- Xenon Strobe:
  - 1Hz flash rate
  - 1.5Hz flash rate
  - Double strike flash pattern
- LED:
  - Steady
  - 2Hz flash rate

### 2) Operating and Marking

All units have the following operating requirements and limitations.

Unit Type No.	Sounder only outputs	
	Voltage Range	Current
D105AX	24Vdc 10-30Vdc	256mA
	Max Current 256mA @ 30Vdc	

DL105AXX & DL105AXH sounder beacon units - Add selected sounder & beacon currents to calculate total current required.

Unit Type No.	Beacon only outputs	
	Voltage Range	Current
Xenon Beacon	12Vdc 10-14Vdc	500mA
	24Vdc 20-28Vdc	250mA

LED Beacon	24Vdc 10-30Vdc	157mA
	Max Current 166mA @ 30Vdc	

Operating Temp: -25 to +55°C  
 IP Rating: Type 4 / 4X / 3R / 13 , IP66

Marking:   

### 3) Installation & Wiring Requirements

#### D105AX

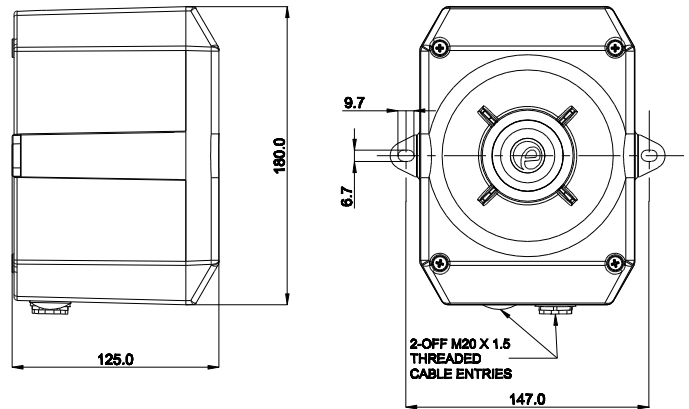

#### DL105AXX & DL105AXH

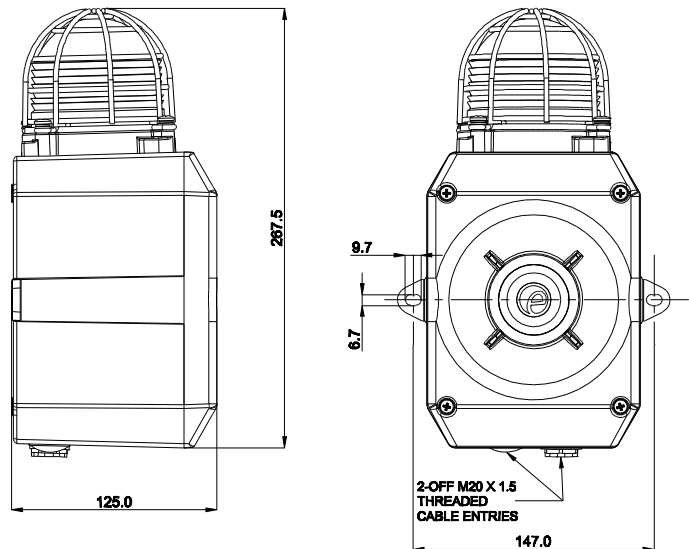

Always de-energize unit before removing cover.

The installation of the units must be in accordance with any local codes that may apply and should only be carried out by a competent trained electrical engineer.

The power terminals on the control unit are clearly marked and will accept up to 1.5mm<sup>2</sup> cable.

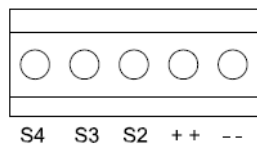

DC Terminals  
 On main PCB.  
 ++ = Positive  
 -- = Negative

The DL105AXX & DL105AXH units will have the beacon already prewired to the unit so no extra wiring is required.

#### 4) Beacon Set-up

The beacon unit may need to be configured dependant on the type of flash required.

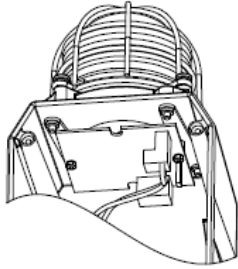

The xenon beacon is set as standard to 1Hz flash rate mode but it can be set to either 1.5Hz flash rate or double Strike flash pattern modes also. To alter the settings, change the position of the header pin as shown:

- Keep header on pins deignated 'A' for 1Hz flash rate mode
- Place header on pins designated 'B' for 1.5Hz flash rate mode
- Place header on pins designated 'C' for double strike flash pattern mode

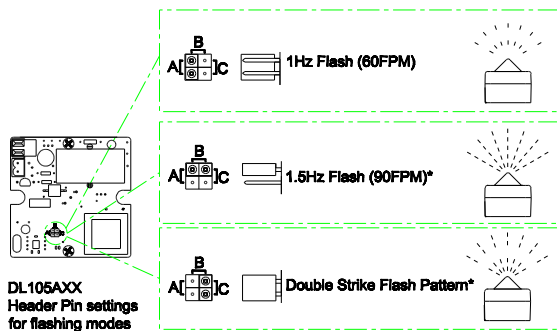

The LED beacon is set as standard to the 2Hz flash mode but it can be set to a steady on mode also. To alter the settings, change the position of the header pin as shown.

- Remove header for steady mode.
- Keep header in standard position for 2Hz flashing mode

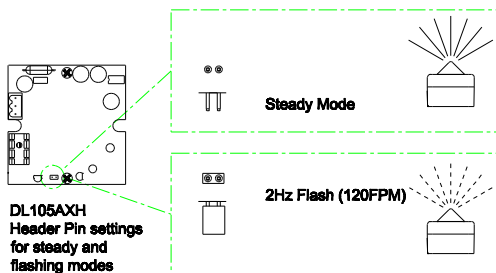

#### 5) Unit Set-up and Recording

The unit will need to be configured to suit the end user.

If recording either via the onboard microphone or the in-line connector the unit will need to be supplied with power.

DC units can be powered when completing recording and set-up.

See section 7) Appello Setup Guide overleaf for Set-up instructions and functions.

#### 6) Tone Selection Table

The Appello unit has 45 different tones (See Table 1) that can be selected for the first stage alarm. The systems can then be switched to sound second, third and fourth stage alarm tones. The tones are selected by operation of a DIP switch S4 on the main PCB.

The tone table (Table 1) shows the switch positions for the 45 tones and which tones are available for the second third and fourth stages.

#### Example

**S4 Dip Switch -  
Shown Set for Tone 1  
(All switches OFF)**

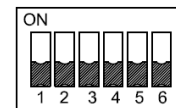

To sound stage one simply connect the supply voltage (+ve and -ve), to the supply input terminals on the correct PCB shown.

#### Second, Third and Fourth Stage Selection

The Appello unit uses -ve switching to change the tone to the second, third and fourth stages.

**Warning! : The negative supply must remain connected to the -(ve) terminal and a link made from this to the appropriate stage (S2) terminal otherwise the unit will be damaged.**

To change to the second, third or fourth stage tone, link the -ve supply line to terminal relevant stage terminal. I.e. for Stage 2 link the -ve supply to the S2 terminal, for Stage 3 link the -ve supply to the S3 terminal etc.

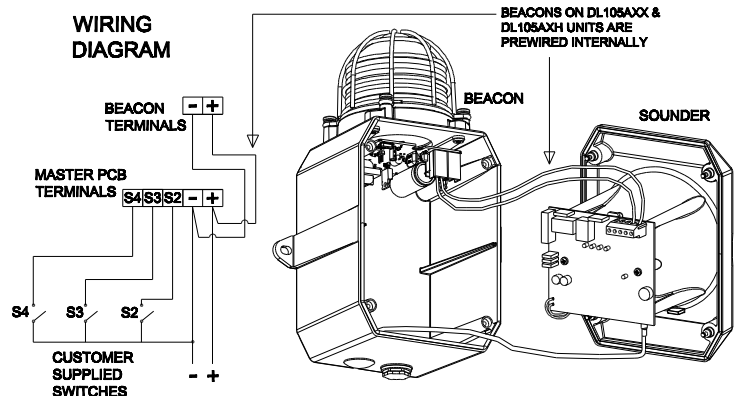

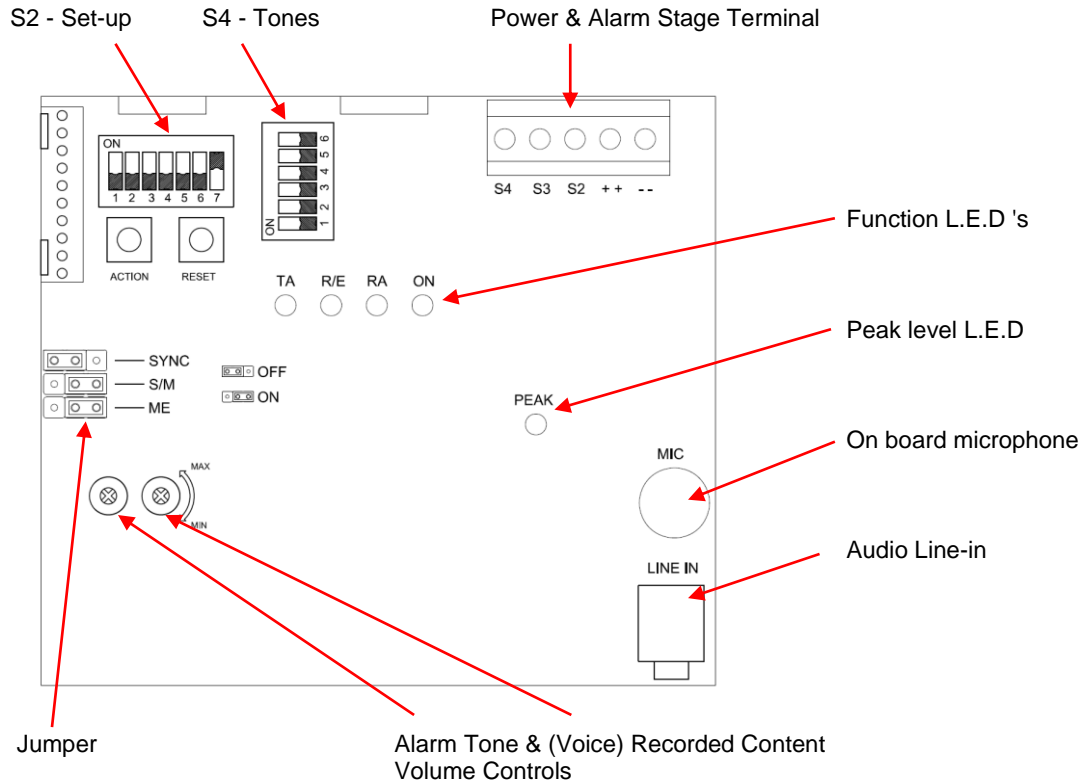

## 7) Appello Setup Guide

The following guide is designed to get the user quickly interfacing with the Appello unit.

- The Appello unit can be set-up to either play an attention seeking tone and then a recorded message or just play the recorded message.
- The user can:
  - Record on each of the 4 stages using either the Line In or Microphone inputs
  - Select the required alarm tone
  - Delete unwanted messages.
- To re-record a message on a particular stage, the previous message on that stage must be deleted first.
- Once the user has configured the unit, it must be put into its Playback Mode and S2 switches set to stage 1, as shown in Quick Ref - Playback Mode (Stage 1 illustrated) guide below.
- The “Mass Erase” function will erase all the recorded stages.
- **The "Mass Erase" can also be used to reset the unit if any functionality is lost.**





**Quick ref - Switch 'S2' Dip Switch Function Settings**

Switch No.	OFF Position Function		ON Position Function
1	Record Mode		Playback Mode
2	Stage selection switch		Switch 2 On & Switch 3 On = Alarm Stage 1 Switch 2 Off & Switch 3 On = Alarm Stage 2 Switch 2 On & Switch 3 Off = Alarm Stage 3 Switch 2 Off & Switch 3 Off = Alarm Stage 4
3	Stage selection switch		
4	Line-In selected		On board Microphone selected
5	Program – Record & Erase Mode ON		Playback – Record & Erase Mode OFF
6	Message & Tone Playback		Message only Playback
7	Single Message or Mass Erase Mode OFF		Single Message or Mass Erase Mode ON



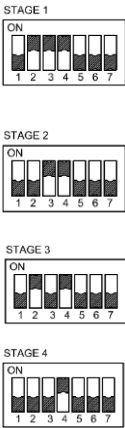

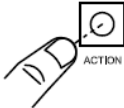
**Quick Ref - Playback Mode (Stage 1 illustrated)**

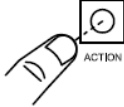
1	<p>For Stage 1: Set Switch 'S2' positions 1,2,3 &amp; 5 to 'ON'</p> <p>Alternatively for :</p> <p>For Stage 2: Set Switch 'S2' positions 1,3 &amp; 5 to 'ON'</p> <p>For Stage 3: Set Switch 'S2' positions 1,2 &amp; 5 to 'ON'</p> <p>For Stage 4: Set Switch 'S2' positions 1 &amp; 5 to 'ON'</p>		<p>TA    R/E    RA    ON</p> <p><input type="radio"/>    <input type="radio"/>    <input type="radio"/>    <input type="radio"/></p>
2	Switch on power or Press reset button		<p>TA    R/E    RA    ON</p> <p><input type="radio"/>    <input type="radio"/>    <input type="radio"/>    <input checked="" type="radio"/></p>
3a	Unit will sound alarm tone and then recorded content repeatedly		<p>TA    R/E    RA    ON</p> <p><input checked="" type="radio"/>    <input type="radio"/>    <input type="radio"/>    <input checked="" type="radio"/></p>

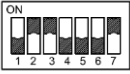
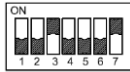
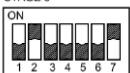

**Quick Ref - Recording Mode (Stage 1 illustrated)**

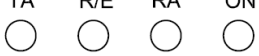
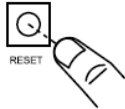
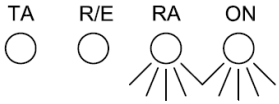
1	<p>For Stage 1: Set Switch 'S2' positions 2,3 &amp; 4 to 'ON'</p> <p>Alternatively for :</p> <p>For Stage 2: Set Switch 'S2' positions 3 &amp; 4 to 'ON'</p> <p>For Stage 3: Set Switch 'S2' positions 2 &amp; 4 to 'ON'</p> <p>For Stage 4: Set Switch 'S2' position 4 to 'ON'</p> <p>To record from Line-in instead of the on board microphone follow above step 1 but set Switch 'S2' position 4 to OFF</p>		<p>TA    R/E    RA    ON</p> <p><input type="radio"/>    <input type="radio"/>    <input type="radio"/>    <input type="radio"/></p>
2	<p>Switch on power or Press reset button</p>		<p>TA    R/E    RA    ON</p> <p><input type="radio"/>    <input type="radio"/>    <input checked="" type="radio"/>    <input type="radio"/></p>
3a	<p>Press action button: Start recording</p>		<p>TA    R/E    RA    ON</p> <p><input type="radio"/>    <input checked="" type="radio"/>    <input checked="" type="radio"/>    <input checked="" type="radio"/></p>
3b	<p>Speak into microphone or plug line-in.</p> <p>It is suggested that a 5cm gap is maintained to the microphone.</p> <p>The peak detector L.E.D should flash regularly to maintain a good recording level. However, if it stays on for most of the time, the recording may be distorted.</p>		<p>TA    R/E    RA    ON</p> <p><input type="radio"/>    <input checked="" type="radio"/>    <input checked="" type="radio"/>    <input checked="" type="radio"/></p> <p>PEAK</p> <p><input checked="" type="radio"/></p>
4	<p>Press action button: Stop recording</p>		<p>TA    R/E    RA    ON</p> <p><input type="radio"/>    <input type="radio"/>    <input checked="" type="radio"/>    <input type="radio"/></p>

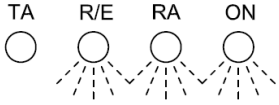
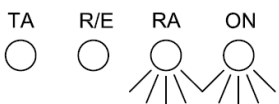
**Quick Ref - Erase Single stage Mode (Stage 1 illustrated)**

1	<p>For Stage 1: Set Switch 'S2' positions 2,3 &amp; 7 to 'ON'</p> <p>Alternatively for :</p> <p>For Stage 2: Set Switch 'S2' positions 3 &amp; 7 to 'ON'</p> <p>For Stage 3: Set Switch 'S2' positions 2 &amp; 7 to 'ON'</p> <p>For Stage 4: Set Switch 'S2' position 7 to 'ON'</p>	<p>STAGE 1</p>  <p>STAGE 2</p>  <p>STAGE 3</p>  <p>STAGE 4</p> 	<p>TA    R/E    RA    ON</p> 
2	<p>Switch on power or Press reset button</p>		<p>TA    R/E    RA    ON</p> 
3a	<p>Press action button: Erase will begin</p>		<p>TA    R/E    RA    ON</p> 
3b	<p>---- erase complete</p>		<p>TA    R/E    RA    ON</p> 

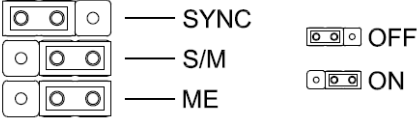
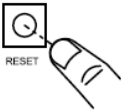
**Quick Ref - Mass Erase Mode (Erases All Stages)**

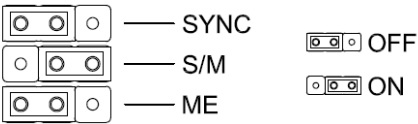
1	Set Switch 'S2' position 7 to 'ON'		<p>TA    R/E    RA    ON</p> <p>○    ○    ○    ○</p>
2	Set jumper J4 'ME' to ON position (centre and right pin connected)		
3	Switch on power or Press reset button		<p>TA    R/E    RA    ON</p> <p>○    ○    ○    ○</p> <p>(R/E, RA, and ON lights are shown with radiating lines)</p>
4a	Press action button: Erase will begin		<p>TA    R/E    RA    ON</p> <p>○    ○    ○    ○</p> <p>(R/E, RA, and ON lights are shown with radiating lines)</p>
4b	- - - - erase complete		<p>TA    R/E    RA    ON</p> <p>○    ○    ○    ○</p> <p>(R/E, RA, and ON lights are shown with radiating lines)</p>
5	Reset Jumper J4 'ME' to OFF position		

**Quick Ref - Synchronising Two Sounders (All stages)**

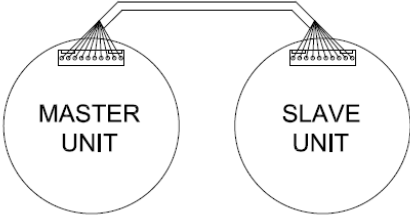
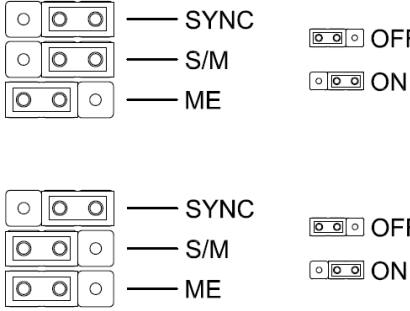
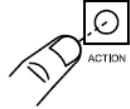
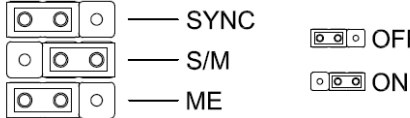
1	Connect Synch cable to Master and Slave PCB		
2	<p>Set 1 off Units as Master and 1 off Unit as Slave Set jumper J6 to Sync on</p> <p>Set jumper J5 S/M on Master unit to master position (on)</p> <p>Set jumper J5 S/M on Slave unit to slave position (off)</p> <p>Position of S2 switch does not affect synch operation.</p>		<p>TA R/E RA ON</p> <p>○ ○ ○ ○</p>
3	<p>Switch on power onto the Master unit first</p> <p>Then switch power onto the Slave unit</p>	<p>Master Unit</p> <p>Slave Unit</p>	<p>TA R/E RA ON</p> <p>○ ● ● ●</p> <p>TA R/E RA ON</p> <p>○ ○ ● ○</p>
4a	Press action button on the Master Unit: Synchronisation will begin	 <p>Master Unit</p> <p>Slave Unit</p>	<p>TA R/E RA ON</p> <p>○ ● ● ○</p> <p>TA R/E RA ON</p> <p>○ ● ● ○</p>
4b	<p>---- Synchronisation complete</p> <p>Switch off Power to units</p>	<p>Master Unit</p> <p>Slave Unit</p>	<p>TA R/E RA ON</p> <p>○ ○ ○ ○</p> <p>TA R/E RA ON</p> <p>○ ○ ● ○</p>
5	<p>Reset on both units jumper J6 to Sync off</p> <p>Set jumper J5 S/M on both units to Master position (on)</p>		



# Table 1: Tone selection table

Stage 1	Frequency Description	Switch						Stage 2	Stage 3	Stage 4
		1	2	3	4	5	6	(S2)	(S3)	(S4)
Tone 1	340 Hz Continuous							Tone 2	Tone 5	Tone 29
Tone 2	800/1000Hz @ 0.25 sec Alternating		■					Tone 17	Tone 5	Tone 29
Tone 3	500/1200Hz @ 0.3Hz 0.5 sec Slow Whoop		■	■				Tone 2	Tone 5	Tone 29
Tone 4	800/1000Hz @ 1Hz Sweeping		■	■				Tone 6	Tone 5	Tone 29
Tone 5	2400Hz Continuous				■			Tone 3	Tone 20	Tone 29
Tone 6	2400/2900Hz @ 7Hz Sweeping		■		■			Tone 7	Tone 5	Tone 29
Tone 7	2400/2900Hz @ 1Hz Sweeping			■	■			Tone 10	Tone 5	Tone 29
Tone 8	500/1200/500Hz @ 0.3Hz Sweeping		■	■	■			Tone 2	Tone 5	Tone 29
Tone 9	1200/500Hz @ 1Hz - DIN / PFEER P.T.A.P.					■		Tone 15	Tone 2	Tone 29
Tone 10	2400/2900Hz @ 2Hz Alternating		■			■		Tone 7	Tone 5	Tone 29
Tone 11	1000Hz @ 1Hz Intermittent			■		■		Tone 2	Tone 5	Tone 29
Tone 12	800/1000Hz @ 0.875Hz Alternating		■			■		Tone 4	Tone 5	Tone 29
Tone 13	2400Hz @ 1Hz Intermittent				■	■		Tone 15	Tone 5	Tone 29
Tone 14	800Hz 0.25sec on, 1 sec off Intermittent		■		■	■		Tone 4	Tone 5	Tone 29
Tone 15	800Hz Continuous			■	■	■		Tone 2	Tone 5	Tone 29
Tone 16	660Hz 150mS on, 150mS off Intermittent		■	■	■	■		Tone 18	Tone 5	Tone 29
Tone 17	544Hz (100mS)/440Hz (400mS) - NF S 32-001					■		Tone 2	Tone 27	Tone 29
Tone 18	660Hz 1.8sec on, 1.8sec off Intermittent		■			■		Tone 2	Tone 5	Tone 29
Tone 19	1.4KHz-1.6KHz 1s, 1.6KHz-1.4KHz 0.5s -NFC48-265			■		■		Tone 2	Tone 5	Tone 29
Tone 20	660Hz Continuous		■	■		■		Tone 2	Tone 5	Tone 29
Tone 21	554Hz/440Hz @ 1Hz Alternating				■	■		Tone 2	Tone 5	Tone 29
Tone 22	544Hz @ 0.875 sec. Intermittent		■		■	■		Tone 2	Tone 5	Tone 29
Tone 23	800Hz @ 2Hz Intermittent			■	■	■		Tone 6	Tone 5	Tone 29
Tone 24	800/1000Hz @ 50Hz Sweeping		■	■		■		Tone 29	Tone 5	Tone 29
Tone 25	2400/2900Hz @ 50Hz Sweeping				■	■		Tone 29	Tone 5	Tone 29
Tone 26	Bell		■		■	■		Tone 2	Tone 15	Tone 29
Tone 27	554Hz Continuous			■	■	■		Tone 26	Tone 5	Tone 29
Tone 28	440Hz Continuous		■		■	■		Tone 2	Tone 5	Tone 29
Tone 29	800/1000Hz @ 7Hz Sweeping				■	■		Tone 7	Tone 5	Tone 29
Tone 30	300Hz Continuous		■		■	■		Tone 2	Tone 5	Tone 29
Tone 31	660/1200Hz @ 1Hz Sweeping			■	■	■		Tone 26	Tone 5	Tone 29
Tone 32	Two tone chime.		■	■	■	■		Tone 26	Tone 15	Tone 29
Tone 33	745Hz @ 1Hz Intermittent						■	Tone 2	Tone 5	Tone 29
Tone 34	1000 & 2000Hz @ 0.5 sec Alternating - Singapore		■				■	Tone 38	Tone 45	Tone 29
Tone 35	420Hz @ 0.625 sec Australian Alert			■			■	Tone 36	Tone 5	Tone 29
Tone 36	500-1200Hz 3.75sec /0.25sec. Australian Evac.		■	■			■	Tone 35	Tone 5	Tone 29
Tone 37	1000Hz Continuous - PFEER Toxic Gas				■		■	Tone 9	Tone 45	Tone 29
Tone 38	2000Hz Continuous		■		■		■	Tone 34	Tone 45	Tone 29
Tone 39	800Hz 0.25sec on, 1 sec off Intermittent			■	■		■	Tone 23	Tone 17	Tone 29
Tone 40	544Hz (100mS)/440Hz (400mS) - NF S 32-001		■	■		■		Tone 31	Tone 27	Tone 29
Tone 41	Motor Siren - slow rise to 1200 Hz					■	■	Tone 2	Tone 5	Tone 29
Tone 42	Motor Siren - slow rise to 800 Hz		■			■	■	Tone 2	Tone 5	Tone 29
Tone 43	1200 Hz Continuous			■		■	■	Tone 2	Tone 5	Tone 29
Tone 44	Motor Siren - slow rise to 2400 Hz		■	■		■	■	Tone 2	Tone 5	Tone 29
Tone 45	1KHz 1s on, 1s off Intermittent - PFEER Gen. Alarm				■	■	■	Tone 38	Tone 34	Tone 29