

INSTRUCTION MANUAL

D1xS1

Alarm Horn Sounder with relay / telephone initiation

Zone 1, 2, 21 & 22

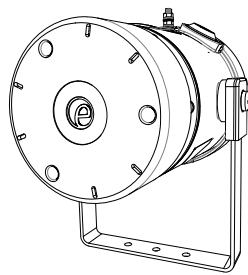

D1xS1R

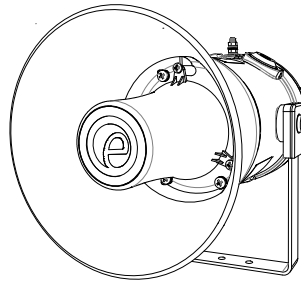

D1xS1F

1. Product Table

Unit Type Code	Nominal Input Voltage	Nominal Input Current	Voltage Range	Sound Pressure Level dB(A)	
				Max*	Nom [†]
D1xS1RDC024-T	24Vdc	185mA	18-30Vdc	110	105
D1xS1RAC230-T	115Vac	73mA	100-240Vac 50/60Hz		
	230Vac	48mA			
D1xS1FDC024-T	24Vdc	185mA	18-30Vdc	115	110
D1xS1FAC230-T	115Vac	73mA	100-240Vac 50/60Hz		
	230Vac	48mA			

*Max = Tone 4
†Nom. = Tone 44

The table shows the input current taken by the various sounders.
The current levels shown above are for the 440Hz Continuous tone @ nominal input voltage.
Nominal current at nominal voltage.
*Special 12Vdc version is available – Contact E2S Sales.

Table 1: Electrical Ratings.

2. Warnings



CAUTION

TO REDUCE THE RISK OF IGNITION OF HAZARDOUS ATMOSPHERES:

DISCONNECT FROM SUPPLY BEFORE OPENING.

KEEP TIGHTLY CLOSED WHEN IN OPERATION.

WARNING

FIT SEALING FITTING IN CONDUIT RUNS WITHIN 18 INCHES FROM ENCLOSURE.

EQUIPMENT MUST NOT BE INSTALLED WITH THE HORN FACING UPWARDS OF HORIZONTAL

DO NOT OPEN WHEN AN EXPLOSIVE ATMOSPHERE IS PRESENT

DO NOT OPEN WHEN ENERGISED

POTENTIAL ELECTROSTATIC CHARGING HAZARD - CLEAN ONLY WITH A DAMP CLOTH

ENCLOSURE ENTRIES: TWIN M20 X 1.5 / SINGLE 1/2" NPT

ATEX/IECEx & UKEx INSTALLATIONS: IF TEMPERATURE EXCEEDS 70°C AT ENTRY OR 80°C AT BRANCHING POINT USE SUITABLE RATED CABLE AND GLANDS

ATTENTION

POUR RÉDUIRE LE RISQUE D'INFLAMMATION DES ATMOSPHÈRES DANGEREUSES :

COUPER L'ALIMENTATION AVANT OUVERTURE.

CONSERVER FERMÉ PENDANT LE FONCTIONNEMENT.

AVERTISSEMENT

CONDUITS DOIVENT ÊTRE SCELLES EN MOINS DE 18 POUCHES.

ÉQUIPEMENT NE DOIT PAS ÊTRE INSTALLÉ AVEC LE KLAXON TOURNÉ VERS LE HAUT DE HORIZONTAL.

NE PAS OUVRIR UN PRÉSENCE D'ATMOSPHÈRE EXPLOSIVE

NE PAS OUVRIR ÉNERGIE

DANGER POTENTIEL CHARGE ÉLECTROSTATIQUE - NETTOYER UNIQUEMENT AVEC UN CHIFFON HUMIDE

ENTRÉES DE BOÎTIER: 2 x M20 X 1.5 / 1 x 1/2" NPT

ATEX/IECEx & UKEx INSTALLATIONS : SI LA TEMPÉRATURE DÉPASSE 70 °C À L'ENTRÉE OU 80 °C AU POINT DE BRANCHEMENT, UTILISER UN CÂBLE ET DES JOINTS D'ÉTANCHÉITÉ APPROPRIÉS

INSTRUCTION MANUAL

D1xS1

Alarm Horn Sounder with relay / telephone initiation

Zone 1, 2, 21 & 22



3. Marking & Rating Information

The D1xS1 Alarm Horns comply with the following standards for hazardous locations:

3.1 ATEX / IECEx & UKEx Ratings

Standards	
EN60079-0:2018/IEC60079-0:2017 (ed.7): Explosive Atmospheres - Equipment General Requirements. EN60079-1:2014/IEC60079-1:2014 (ed.7): Explosive Atmospheres - Equipment Protection by Flameproof Enclosures "d". EN60079-31:2014/IEC60079-31:2013 (ed.2): Explosive Atmospheres - Equipment Dust Ignition Protection by enclosure "t".	
Model No:	Rating
D1xS1-DC024-T	Ex db IIC T5 Gb Ta -55°C to +75°C Ex db IIC T6 Gb Ta -55°C to +70°C Ex tb IIIC T84°C Db Ta -55°C to +75°C
D1xS1-AC230-T	Ex db IIC T5 Gb Ta -55°C to +75°C Ex db IIC T6 Gb Ta -55°C to +70°C Ex tb IIIC T82°C Db Ta -55°C to +75°C
See Product table for electrical ratings of each unit model	

Certificate No. DEMKO 19ATEX2141X
IECEx ULD 19.0008X
UKEx UL UL21UKEX2132X

Epsilon x
Equipment Group
and Category:



II 2G
II 2D

CE Marking and
Notified Body No.



2813

UKCA Marking and
Notified Body No.



0518

4. Zones, Gas Group, Category and Temperature Classification

The units can be installed in locations with the following conditions:

Area Classification Gas	
Zone 1	Explosive gas air mixture likely to occur in normal operation.
Zone 2	Explosive gas air mixture not likely to occur in normal operation, and if it does, it will only exist for a short time.
Gas Groupings	
Group IIA	Propane
Group IIB	Ethylene
Group IIC	Hydrogen and Acetylene
Temperature Classification for Gas Applications	
T1	450° C
T2	300° C
T3	200° C
T4	135° C
T5	100° C
T6	85° C (D1xS1 up to 70° C ambient)
Area Classification Dust	
Zone 21	Explosive dust air mixture likely to occur in normal operation.
Zone 22	Explosive dust air mixture not likely to occur in normal operation, and if it does, it will only exist for a short time.
Dust Groupings	
Group IIIA	Combustible Dusts
Group IIIB	Non-Conductive Dusts
Group IIIC	Conductive Dusts
Equipment Category	
2G, 2D	
Equipment Protection Level	
Gb, Gc, Db, Dc	
Maximum Surface Temperature for Dust Applications	
84° C (D1xS1-DC024-T) 82° C (D1xS1-AC230-T)	
Ambient Temperature Range	
-55° C to +75° C (-67° F to +167° F)	
IP Rating	
IP66 to EN60529 4 / 4X / 3R / 13 to UL50E / NEMA250	
Installation must be carried out in compliance with the latest issue of the following standards:	
EN60079-14 / IEC60079-14: Explosive atmospheres - Electrical installations design, selection and erection EN60079-10-1 / IEC60079-10-1: Explosive atmospheres - Classification of areas. Explosive gas atmospheres EN60079-10-2 / IEC60079-10-2: Explosive atmospheres - Classification of areas. Explosive dust atmospheres	

INSTRUCTION MANUAL

D1xS1

Alarm Horn Sounder with relay / telephone initiation

Zone 1, 2, 21 & 22



5. Specific Conditions of Installation

ATEX/IECEX & UKEx Installations:

The cable entries have two M20 x 1.5 – 6H entry thread and a single ½" NPT thread. If the installation is made using cable glands, only suitably rated ATEX/IECEX or UKEx certified cable glands must be used. They must be suitable for the type of cable being used and also meet the requirements of the current installation standards EN 60079-14 / IEC60079-14.

If the installation is made using conduit, openings must have a sealing fitting connected as close as practical to the wall of the enclosure, but in no case more than the size of the conduit or 50mm, whichever is the lesser.

Any unused cable entries must be closed with suitably rated and UKEx certified blanking plugs.

For high ambient temperatures the cable entry temperature may exceed 70°C or the cable branching point temperature may exceed 80°C and therefore suitable heat resisting cables and cable glands must be used, with a rated service temperature at least as stated below:

Minimum Ratings of Cables & Cable Glands					
Max Ambient Temp (°C)	55	60	65	70	75
D1xS1-DC024-T Min. Rating (°C)	70	75	80	85	90
D1xS1-AC230-T Min. Rating (°C)		70	75	80	85

Table 2: ATEX/IECEX & UKEx Min. Ratings of Cables & Cable Glands.

The plastic horn is not anti-static and the metallic enclosure has a non-conductive coating. These may generate an ignition-capable level of electrostatic charges under certain extreme conditions. The user should ensure that the equipment is not installed in a location where it may be subjected to external conditions that might cause a build-up of electrostatic charges on non-conducting surfaces.

Only the explosionproof cover is to be used for access to the enclosure for installation, service and maintenance.

6. Specific Conditions for Safe Use

Flameproof threaded joints and cemented joints are not permitted to be repaired.

7. Product Mounting and Access

7.1 Mounting

The D1x Alarm Horn may be secured to any flat surface using at least two of the three or four 7mm fixing holes. The enclosure provides IP66 protection and is suitable for installation in exterior locations providing it is positioned so that water cannot collect in the horn, and the cable entry is sealed.

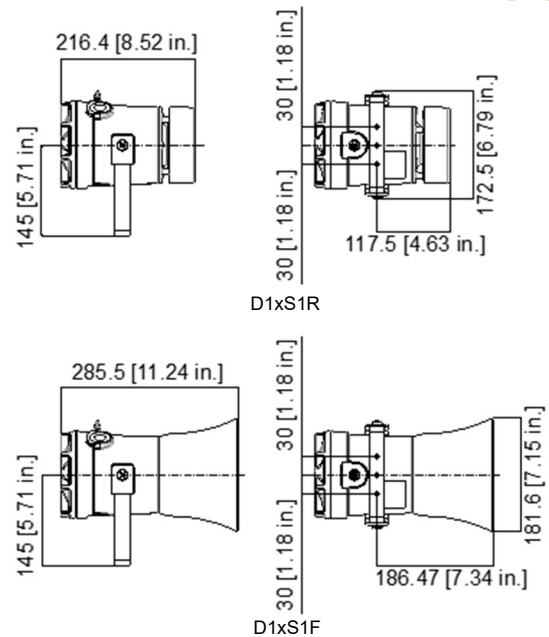
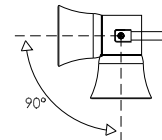

Fig 1: Mounting Locations

The Equipment must not be installed with the horn facing upwards of horizontal.



7.2 Installation procedure

- Secure the D1x unit to a flat surface via the three 7mm fixing holes in the mounting bracket.
- Remove the explosionproof cover of the alarm horn by unscrewing it, taking care not to damage the explosionproof threads in the process (Refer to section 7.4).
- Fit an M20/NPT suitably rated cable gland or conduit entry into the hole in the enclosure and connect the field wiring to the appropriate alarm horn terminals as shown in D190-06-005 (AC) or D190-06-001. (DC). The power supply terminals are duplicated so that units may be connected in parallel. An end of line monitoring resistor may be fitted to DC units only (see section 10). If the second and third M20/NPT entries are not used, suitably rated stopping plugs must always be fitted.
- Replace the explosionproof cover of the loudspeaker, taking care not to damage the explosionproof threads. Tighten fully.

7.3 Hornless Variants

The D1x Sounder is also available as a variant with no horn fitted in the factory. The Horn threaded nose portion has a fitment thread of 1-3/8" – 18 UNF (to BS1580 or ANSI B1.1). The customer is responsible for sourcing and correctly fitting a suitable horn that meets all of the relevant safety requirements.

INSTRUCTION MANUAL

D1xS1

Alarm Horn Sounder with relay / telephone initiation

Zone 1, 2, 21 & 22



7.4 Access to the Explosionproof Enclosure

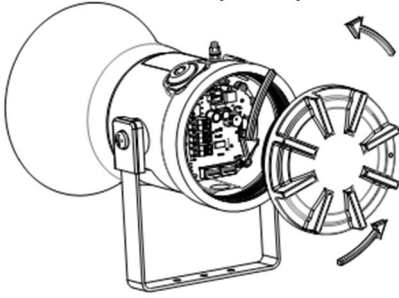

Fig 2: Accessing the enclosure

To access the Ex d chamber, loosen the M4 grub screw on the sounder cover. Open the enclosure by turning the sounder cover counter clockwise and remove the cover. Take extreme care not to damage the explosionproof threads in the process.

On completion of the installation the flameproof threaded joint should be inspected to ensure that they are clean and that they have not been damaged during installation.

Ensure the O-ring seal is in place and undamaged.

When fitting the flameproof cover ensure the thread is engaged correctly. Fully tighten the cover all the way, ensure no gap is visible between the cover and base of the sounder enclosure.

8. Installation Requirements

8.1 Safe Installation Requirements



Warning – High voltage may be present, risk of electric shock.
DO NOT open when energised, disconnect power before opening.

The sounder must only be installed by suitably qualified personnel in accordance with the latest issues of the relevant standards.

The product must only be installed by suitably qualified personnel in accordance with the latest issues of the relevant standards.

8.2 Cable Selection and Connections

Electrical connections are to be made into the terminal blocks on the PCBA, using solid wire 0.5-4mm² / AWG 20-12 or stranded wire, sizes 0.5-2.5mm² / AWG 24-14. Wire insulation needs to be stripped 8mm. Wires may be fitted securely with crimped ferrules. Terminal screws need to be tightened down with a tightening torque of 0.45 Nm / 3.5 Lb-in.

When selecting the cable size, consideration must be given to the input current that each unit draws (see table 1), the number of sounders on the line and the length of the cable runs. The cable size selected must have the necessary capacity to provide the input current to all the sounders connected to the line.

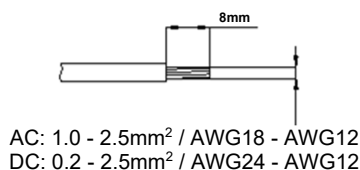

Fig 3: Wire Preparation.

When connecting wires to the terminals great care should be taken to dress the wires so that when the cover is inserted into the chamber the wires do not exert excess pressure on the terminal blocks. This is

particularly important when using cables with large cross-sectional areas such as 2.5mm².

8.3 Earthing

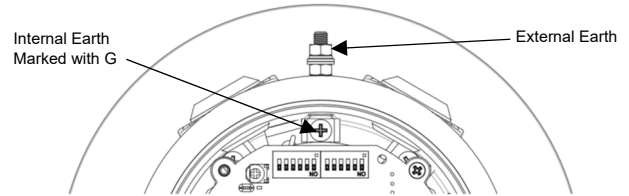

Fig. 4 Earth Locations

Please note that for AC supply voltage product versions the Earth terminal on the PCBA does not provide an earth connection to the product enclosure. The enclosure must be independently earthed using either the external or internal earth fixing point. (see fig 4 and notes below).

The unit has both a primary internal and secondary external earth fixing point.

Internal earth connections should be made to the internal Earth terminal in the base of the housing using a ring crimp terminal to secure the earth conductor under the earth clamp. The earth conductor should be at least equal in size and rating to the incoming power conductors but at least a minimum of 0.82mm² / 18AWG in size.

External earth connections can be made to the M5 earth stud (see Fig. 4), using a ring crimp terminal to secure the earth conductor to the earth stud. The external earth conductor should be at least 4mm² in size.

The external earth crimp ring should be located between the two M5 plain washers provided and securely locked down with the M5 spring washer and M5 nut.

8.4 Cable Glands, Blanking Elements & Adapters

Ingress Protection

If a high IP (Ingress Protection) rating is required then a suitable sealing washer must be fitted under the cable glands or blanking plugs. A minimum ingress protection rating of IP6X must be maintained for installations in explosive dust atmospheres.

To maintain the ingress protection rating and mode of protection, the cable entries must be fitted with suitably rated cable entry and/or blanking devices during installation.

If entries are fitted with adaptors they must be suitably rated for the application. Fitting of blanking elements into adaptors is not permitted.

Adapters

The D1x sounder range can be supplied with the following types of adapters:

- M20 to 1/2" NPT
- M20 to 3/4" NPT
- M20 to M25

It is important to note that stopping plugs cannot be fitted onto adapters, only directly onto the M20 entries.

INSTRUCTION MANUAL

D1xS1

Alarm Horn Sounder with relay / telephone initiation

Zone 1, 2, 21 & 22



9. Relay / Telephone Inputs and Settings

9.1 Power Input Terminal for AC & DC Wiring

A suitable power supply (DC or AC voltage) cable should enter via one of the M20 entries and is to be connected to terminal TB1 (see Fig. 5 below). This provides the alarm horn sounder with continuous power.

DC Unit option: Connect the alarm horn sounder power input (+) to the (L/+) terminal (TB1) and power input (-) to the (N/-) at terminal (TB1).

AC Unit option: Connect the alarm horn sounder power input (L) to the (L/+) terminal (TB1) and power input (N) to (N/-) also an earth/ground input to the (E) terminal (TB1).

Please note: the earth/ground terminal of TB1 provides termination only for an earth/ground cable. Refer to section 8.3.

For AC and DC voltage wiring diagrams see document D250-06-001

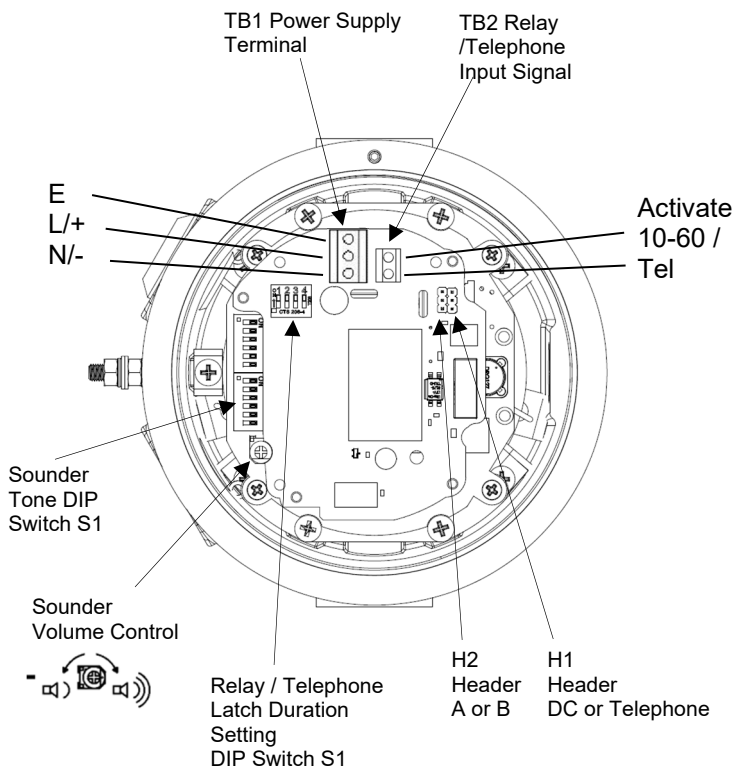

Fig 5 : Input Wiring, DIP settings and Header Positions

9.2 Activation, Relay / Telephone Wiring Inputs and Signal Type Header Setting (H1)

The H1 header selection configures the activation signal type.

Select H1 position marked AC for activation from an analogue telephone external ringer output REN1 (typically low current AC voltage around 90 to 150Vac)

Select H1 position marked DC for activation via a DC voltage input of 10 to 60Vdc e.g. a digital PBX external ringer output or a safety system relay output.

The activation input cables should utilise the second M20 cable entry and connect to terminal TB2.

Note: there is no polarity for this input.

Factory default H1 is set as AC for activation signal.

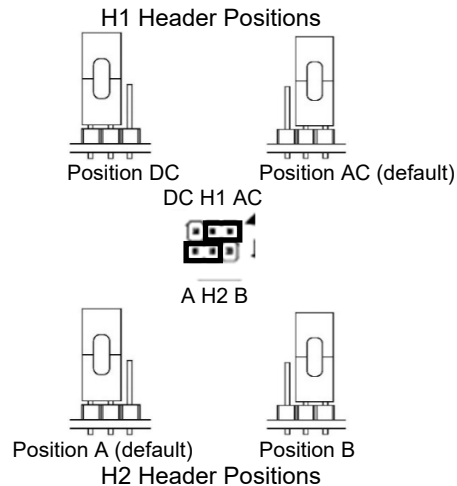

Fig 6 : Header H1 and H2 Positions

9.3 Unit Activation Mode - Pulsed or Latched, Header Setting (H2)

The H2 header selection configures the alarm horn sounder operation depending upon the type of activation signal.

Select H2 position option marked A for pulsed/cadence mode. The alarm horn sounder audible output will follow the telephone ring cadence or a pulsed relay input.

Option A is the factory default setting.

Select H2 position option marked B for latched mode. The alarm horn sounder audible output will start when an initiation signal is received and will not follow the telephone ringing cadence. See section 9.4

9.4 Unit Latch mode duration DIP switch S1 setting

The relay/telephone latch duration setting is only applicable when Header H2 is set to latched mode via header pin set to position option B.

The alarm horn sounder is activated on the first telephone ring (or relay pulsed input) and any other subsequent inputs and will remain activated for the duration as set by DIP switch S1.

This feature is useful where some countries have short ringing cadence with long off cycle times and the customer requires the alarm sounder to operate for longer periods to better attract attention.

Where this feature becomes essential is for telephone/relay activated beacons to function correctly in these parameters.

INSTRUCTION MANUAL

D1xS1

Alarm Horn Sounder with relay / telephone initiation

Zone 1, 2, 21 & 22



Factory default for the relay/telephone latch duration switch setting is 0000.

See table for DIP switch S1 delay timing.

Unit activation period (s) from start of activation signal.	DIP Switch S1 Setting (0000) = All off
1.5	0000
2.0	1000
2.5	0100
3.0	1100
3.5	0010
4.0	1010
4.5	0110
5.0	1110
5.5	1111

10. Sounder Tone Selection DIP switch S1 setting

The D1x Alarm Horn Sounders have 64 different tones. The alarm tone is selected by operation of the tone setting DIP switch S1 (see fig 5) on the PCB. Note DIP switch S2 and multistage selection is not possible with Relay / telephone activation unit.

11. Maintenance, Overhaul and Repair

Maintenance, repair and overhaul of the equipment should only be carried out by suitably qualified personnel in accordance with the current relevant standards:

For ATEX/IECEX or UKEx:

EN60079-19/IEC60079-19

Explosive atmospheres – Equipment repair, overhaul and reclamation

EN 60079-17/IEC60079-17

Explosive atmospheres – Electrical installations inspection and maintenance

Units must not be opened while an explosive atmosphere is present.

If opening the unit during maintenance operations, a clean environment must be maintained and any dust layer removed prior to opening the unit.

Potential electrostatic charging hazard – Clean only with a damp cloth.

Default = Switch 2
Not used in this unit.

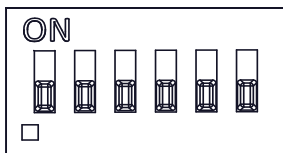

Default = Switch 1
S1 – Tone 44
1 1 0 1 0 1

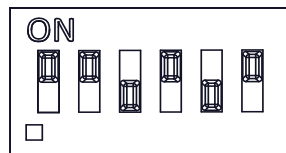

(ON = 1, OFF = 0)

Figure 7: DIP switch configuration

The tone table (D221-95-001-IS) shows the switch positions for the 64 tones, dependent on the sounder Stage 1 DIP switch S1 setting.

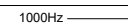
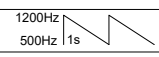
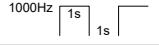
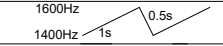
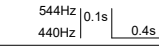
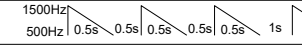
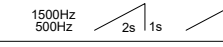
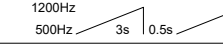
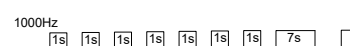
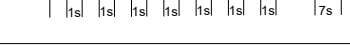
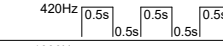
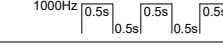
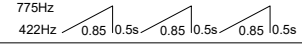
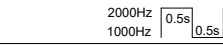
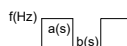
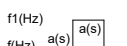
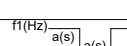
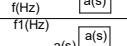
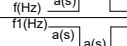
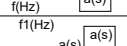
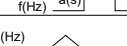
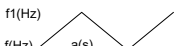
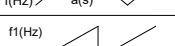
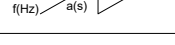
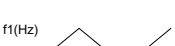
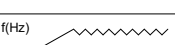
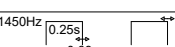
Stage 1 Set DIP SW 1 Tone No.	Tone Description	Tone Visual	Stage 1 & 2 DIP SW 1/2 Settings 1 2 3 4 5 6	Stage 3 Set DIP SW 1 (S3)	Stage 4 Set DIP SW 1 (S2 + S3)
1	1000Hz PFEER Toxic Gas		0 0 0 0 0 0	2	44
2	1200/500Hz @ 1Hz DIN /PFEER P.T.A.P.		1 0 0 0 0 0	3	44
3	1000Hz @ 0.5Hz(1s on, 1soff) PFEER Gen. Alarm		0 1 0 0 0 0	2	44
4	1.4KHz-1.6KHz 1s, 1.6KHz-1.4KHz 0.5s NF C 48-265		1 1 0 0 0 0	24	1
5	544Hz(100mS)/440Hz (400mS) NF S 32-001		0 0 1 0 0 0	19	1
6	1500/500Hz - (0.5s on , 0.5s off) x3 + 1s gap AS4428		1 0 1 0 0 0	44	1
7	500-1500Hz Sweeping 2 sec on 1 sec off AS4428		0 1 1 0 0 0	44	1
8	500/1200Hz @ 0.26Hz (3.3son, 0.5s off) Netherlands - NEN 2575		1 1 1 0 0 0	24	35
9	1000Hz (1s on, 1s off)x7 + (7s on, 1s off) IMO Code 1a		0 0 0 1 0 0	34	1
10	1000Hz (1s on, 1s off)x7 + (7s on, 1s off) IMO Code 1a		1 0 0 1 0 0	34	1
11	420Hz(0.5s on, 0.5s off)x3 + 1s gap ISO 8201 Temporal Pattern		0 1 0 1 0 0	1	8
12	1000Hz(0.5s on, 0.5s off)x3 + 1s gap ISO 8201 Temporal Pattern		1 1 0 1 0 0	1	8
13	422/775Hz - (0.85 on, 0.5 off) x3 + 1s gap NFPA - Temporal Coded		0 0 1 1 0 0	1	8
14	1000/2000Hz @ 1Hz Singapore		1 0 1 1 0 0	3	35
15	300Hz Continuous (f=300)		0 1 1 1 0 0	24	1
16	440Hz Continuous (f=440)		1 1 1 1 0 0	24	1
17	470Hz Continuous (f=470)		0 0 0 0 1 0	24	8
18	500Hz Continuous IMO code 2 (Low) (f=500)		1 0 0 0 1 0	24	8
19	554Hz Continuous (f=554)		0 1 0 0 1 0	24	8
20	660Hz Continuous (f=660)		1 1 0 0 1 0	24	35
21	800Hz IMO code 2 (High) (f=800)		0 0 1 0 1 0	24	35
22	1200Hz Continuous (f=1200)		1 0 1 0 1 0	24	35
23	2000Hz Continuous (f=2000)		0 1 1 0 1 0	3	35
24	2400Hz Continuous (f=2400)		1 1 1 0 1 0	20	35
25	440Hz @0.83Hz (50 cycles/minute) Intermittent (f=440, a=0.6, b=0.6)		0 0 0 1 1 0	44	8
26	470Hz @0.9Hz - 1.1s Intermittent (f=470, a=0.55, b=0.55)		1 0 0 1 1 0	44	8
27	470Hz @5Hz - (5 cycles/second) Intermittent (f=470, a=0.1, b=0.1)		0 1 0 1 1 0	44	8
28	544Hz @ 1.14Hz - 0.875s Intermittent (f=470, a=0.43, b=0.44)		1 1 0 1 1 0	24	8
29	655Hz @ 0.875Hz Intermittent (f=655, a=0.57, b=0.57)		0 0 1 1 1 0	24	8
30	660Hz @0.28Hz - 1.8sec on, 1.8sec off Intermittent (f=660, a=1.8, b=1.8)		1 0 1 1 1 0	24	8
31	660Hz @3.34Hz - 150mS on, 150mS off Intermittent (f=660, a=0.15, b=0.15)		0 1 1 1 1 0	24	8
32	745Hz @ 1Hz Intermittent (f=745, a=0.5, b=0.5)		1 1 1 1 1 0	24	8
33	800Hz - 0.25sec on, 1 sec off Intermittent (f=800, a=0.25, b=1)		0 0 0 0 0 1	24	8
34	800Hz @ 2Hz IMO code 3.a (High) Intermittent (f=800, a=0.25, b=0.25)		1 0 0 0 0 1	24	19
35	1000Hz @ 1Hz Intermittent (f=1000, a=0.5, b=0.5)		0 1 0 0 0 1	24	19
36	2400Hz @ 1Hz Intermittent (f=2400, a=0.5, b=0.5)		1 1 0 0 0 1	24	19
37	2900Hz @ 5Hz Intermittent (f=2900, a=0.1, b=0.1)		0 0 1 0 0 1	24	19
38	363/518Hz @ 1Hz Alternating (f=363, f1=518, a=0.1)		1 0 1 0 0 1	8	19
39	450/500Hz @ 2Hz Alternating (f=450, f1=500, a=0.25)		0 1 1 0 0 1	8	19
40	554/440Hz @ 1Hz Alternating (f=440, f1=554, a=0.5)		1 1 1 0 0 1	24	19
41	554/440Hz @ 0.625Hz Alternating (f=440, f1=554, a=0.8)		0 0 0 1 0 1	8	19
42	561/760Hz @0.83Hz (50 cycles/minute) Alternating (f=561, f1=760, a=0.6)		1 0 0 1 0 1	8	19
43	780/600Hz @ 0.96Hz Alternating (f=600, f1=780, a=0.52)		0 1 0 1 0 1	8	19
44	800/1000Hz @ 2Hz Alternating (f=800, f1=1000, a=0.25)		1 1 0 1 0 1	24	19
45	970/800Hz @ 2Hz Alternating (f=800, f1=970, a=0.25)		0 0 1 1 0 1	8	19
46	800/1000Hz @ 0.875Hz Alternating (f=800, f1=1000, a=0.57)		1 0 1 1 0 1	24	19
47	2400/2900Hz @ 2Hz Alternating (f=2400, f1=2900, a=0.25)		0 1 1 1 0 1	24	19
48	500/1200Hz @ 0.3Hz Sweeping (f=500, f1=1200, a=3.34)		1 1 1 1 0 1	24	12
49	560/1055Hz @ 0.18Hz Sweeping (f=560, f1=1055, a=5.47)		0 0 0 0 1 1	24	12
50	560/1055Hz @ 3.3Hz Sweeping (f=560, f1=1055, a=0.3)		1 0 0 0 1 1	24	12
51	600/1250Hz @ 0.125Hz Sweeping (f=600, f1=1250, a=8)		0 1 0 0 1 1	24	12
52	660/1200Hz @ 1Hz Sweeping (f=660, f1=1200, a=1)		1 1 0 0 1 1	24	12
53	800/1000Hz @ 1Hz Sweeping (f=800, f1=1000, a=1)		0 0 1 0 1 1	24	12
54	800/1000Hz @ 7Hz Sweeping (f=800, f1=1000, a=0.14)		1 0 1 0 1 1	24	12
55	800/1000Hz @ 50Hz Sweeping (f=800, f1=1000, a=0.02)		0 1 1 0 1 1	24	12
56	2400/2900Hz @ 7Hz Sweeping (f=2400, f1=2900, a=0.14)		1 1 1 0 1 1	24	12
57	2400/2900Hz @ 1Hz Sweeping (f=2400, f1=2900, a=1)		0 0 0 1 1 1	24	12
58	2400/2900Hz @ 50Hz Sweeping (f=2400, f1=2900, a=0.02)		1 0 0 1 1 1	24	12
59	2500/3000Hz @ 2Hz Sweeping (f=2500, f1=3000, a=0.5)		0 1 0 1 1 1	24	12
60	2500/3000Hz @ 7.7Hz Sweeping (f=2500, f1=3000, a=0.13)		1 1 0 1 1 1	24	12
61	800Hz Motor Siren (f=800, a=1.6)		0 0 1 1 1 1	24	12
62	1200Hz Motor Siren (f=1200, a=2)		1 0 1 1 1 1	24	12
63	2400Hz Motor Siren (f=2400, a=1.7)		0 1 1 1 1 1	24	12
64	Simulated Bell		1 1 1 1 1 1	21	12

1	2	3	4	5	6	7	8	9	10
							ISSUE	MOD No.	REASON - INITIAL - DATE
							A		INTRODUCTION RNP 31/03/2023

DC Power Input Configuration Config.: 1

Used to Activate DC Sounder or Beacon Units
With Telephone or Relay Signal



Maintain DC Power to TB1
Stage 1 only : Apply Signal to TB2 Singal Input Terminals

AC Power Input Configuration Config.: 2

Used to Activate AC Sounder or Beacon Units
With Telephone or Relay Signal

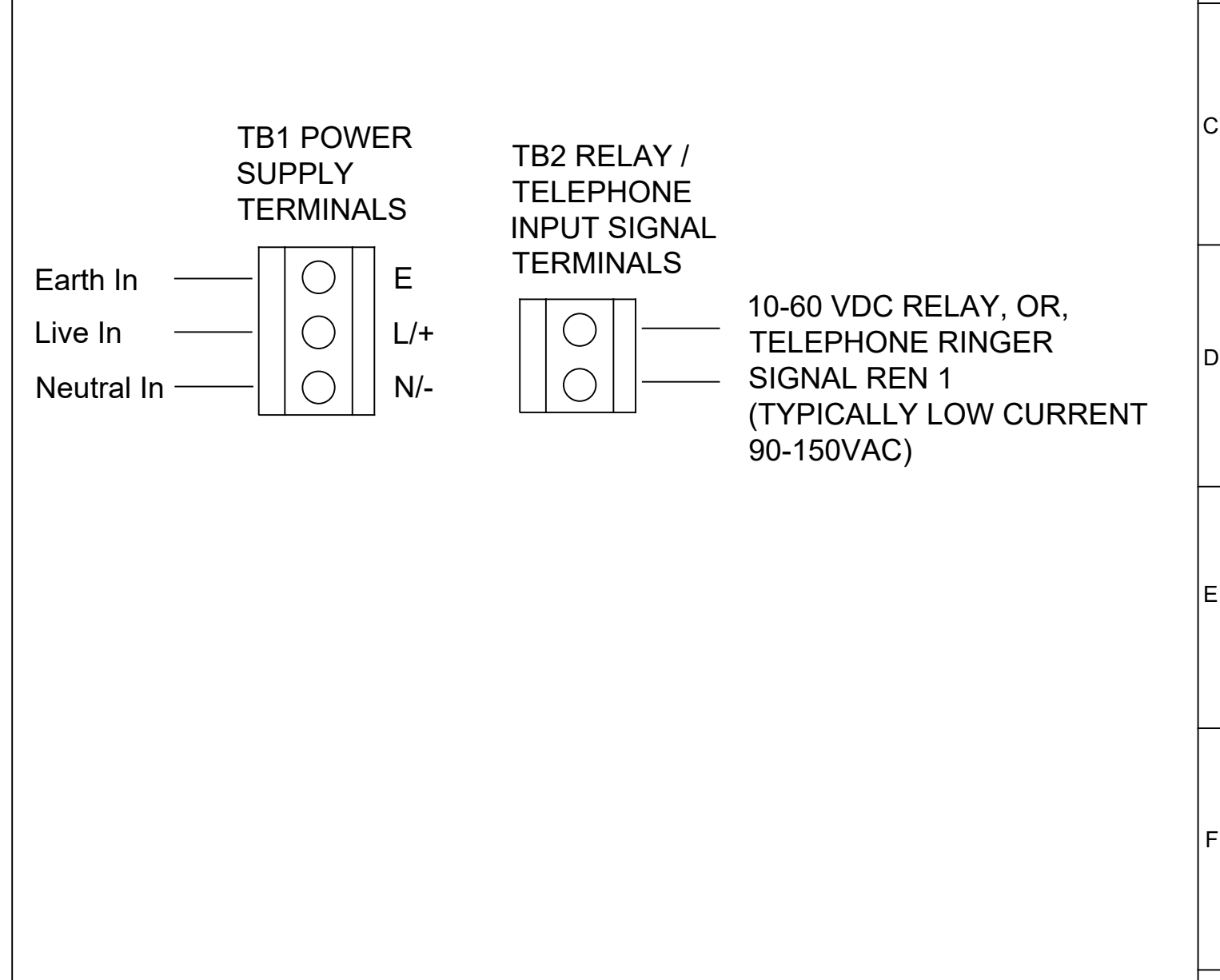
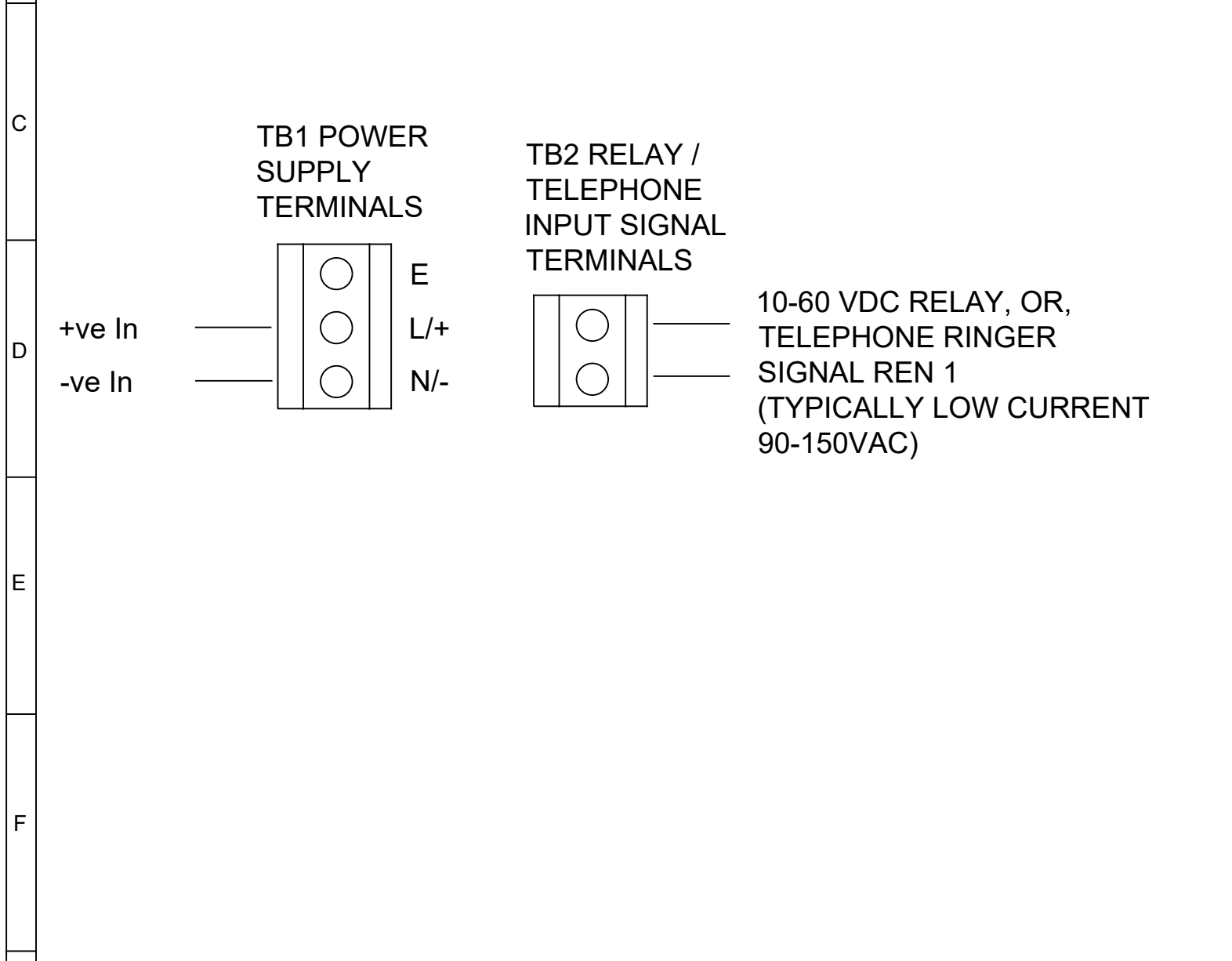
Maintain AC Power to TB1
Stage 1 only : Apply Signal to TB2 Singal Input Terminals



DRAWING TO BS8888:2000 GEOMETRIC TOLERANCES TO ISO1101:1983 LINEAR DIMENSIONAL TOLS ANGULAR DIMENSIONAL TOLS	DRAWN	DATE	SURFACE FINISH	WEIGHT (Kg)	THIS DRAWING AND ANY INFORMATION OR DESCRIPTIVE MATTER THEREIN IS COMMUNICATED IN CONFIDENCE AND IS THE COPYRIGHT PROPERTY OF EUROPEAN SAFETY SYSTEMS LTD. NEITHER THE WHOLE OR ANY EXTRACT MAY BE DISCLOSED, LOANED, COPIED OR USED FOR MANUFACTURING OR TENDERING PURPOSES WITHOUT THEIR WRITTEN CONSENT.	 warning signals EUROPEAN SAFETY SYSTEMS LTD IMPRESS HOUSE MANSELL ROAD ACTON LONDON W3 7QH WWW.E2S.COM	ALL DIMENSIONS IN MM	 	A3
	R.N.POTTS	16/03/2023					MATERIAL		
	CHECKED	DATE	ALTERNATIVE MATERIAL	TITLE TELEPHONE / RELAY ACTIVATION MODULE WIRING DIAGRAMS					
	R.S.RAIT	16/03/2023		STANDARDS			SCALE	SHEET	DRAWING NUMBER
ALERTALARM RANGE	APPROVED	DATE				NTS	1 OF 1	D250-06-001	
	R.N.POTTS	16/03/2023							

EU Declaration of Conformity



Manufacturer: European Safety Systems Ltd.
Impress House, Mansell Road, Acton
London, W3 7QH
United Kingdom

Authorised Representative: E2S Warnsignaltechnik UG
Charlottenstrasse 45-51
72764 Reutlingen
Germany

Equipment Type: D1xS1, D1xS2
D1xL1, D1xL2
D1xC1X05, D1xC1X10, D1xC2X05, D1xC2X10
D1xB2XH1, D1xB2XH2

Directive 2014/34/EU: Equipment and Protective Systems for use in Potentially Explosive Atmospheres (ATEX) - D1xS1, D1xS2, D1xL1, D1xL2, D1xC1X05, D1xC1X10, D1xC2X05 and D1xC2X10 only

Notified Body for EU type Examination (Module B):	UL International Demko A/S Borupvang 5A 2750 Ballerup Denmark
EU-type Examination Certificate (Module B):	DEMKO 19 ATEX 2141X
Notified Body for Quality Assurance Notification / Conformity to EU-type based on quality assurance of the production process (Module D):	Sira Certification Service Notified Body No.: 2813 Unit 6, Hawarden Industrial Park, Hawarden, Deeside, CH5 3US, UK
Quality Assurance Notification (Module D):	SIRA 05 ATEX M342
Provisions fulfilled by the equipment:	II 2G Ex db IIC T6...T3 GB II 2D Ex tb IIIC T82°C...145°C Db
Standards applied:	EN 60079-0:2018 EN 60079-1:2014 EN60079-31:2014

Directive 2014/30/EU: Electromagnetic Compatibility Directive (EMC)

Standards applied:	EN 61000-6-1:2007 EN 61000-6-2:2005 EN 61000-6-3:2007 / A1:2011 / AC: 2012 EN 61000-6-4:2007 / A1: 2011
--------------------	--

Directive 2014/35/EU: Low Voltage Directive (LVD)

Standards applied:	EN 60947-1:2007 + A2:2014
--------------------	---------------------------

Directive 2011/65/EU: Restriction of the use of certain hazardous substances in electrical and electronic equipment (RoHS)

The product and all the components contained within it are in accordance with the restriction of the use of hazardous substances in electrical and electronic equipment, including amendment by Directive 2015/863/EU.

Regulation (EC) 1907/2006: Registration, Evaluation, Authorisation and Restriction of Chemicals (REACH)

The product and all the components contained within it are free from substances of very high concern.

Other Standards and Regulations

EN 60529:1992+A2:2013 - Degrees of protection provided by enclosures (IP code) – enclosure rated IP66

EU Declaration of Conformity



On behalf of European Safety Systems Ltd., I declare that, on the date the equipment accompanied by this declaration is placed on the market, the equipment conforms with all technical and regulatory requirements of the above listed directives, regulations and standards.

This Declaration is issued under the sole responsibility of the manufacturer.

A handwritten signature in black ink, appearing to read 'Martin Streetz'.

Martin Streetz
Quality Assurance Manager

Document No.: DC-067_Issue_H
Date and Place of Issue: London, 10/02/2022



UKCA Declaration of Conformity



Manufacturer: European Safety Systems Ltd.
Impress House, Mansell Road, Acton
London, W3 7QH
United Kingdom

Equipment Type: D1xS1, D1xS2
D1xL1, D1xL2
D1xC1X05, D1xC1X10, D1xC2X05, D1xC2X10

Directive UKSI 2016:1107 (as amended by UKSI 2019:696) – Schedule 3A, Part 1 : Product or Protective System Intended for use in Potentially Explosive Atmospheres (UKCA)

Notified Body for UK type Examination (Module B):	UL International (UK) Ltd Notified Body No.: 0843 Unit 1-3 Horizon Kingsland Business Park, Wade Road, Basingstoke, Hampshire RG24 8AH UK
UK-type Examination Certificate (Module B):	UL21UKEX2132X
Notified Body for Quality Assurance Notification / Conformity to EU-type based on quality assurance of the production process (Module D):	Sira Certification Service Notified Body No.: 0518 Rake Lane, Eccleston, Chester CH4 9JN, UK
Quality Assurance Notification (Module D):	CSAE 22UKQAN0046
Provisions fulfilled by the equipment:	II 2G Ex db IIC T6...T3 GB II 2D Ex tb IIIC T82°C...145°C Db
Standards applied:	EN 60079-0:2018 EN 60079-1:2014 EN60079-31:2014

Directive 2014/30/EU: Electromagnetic Compatibility Directive (EMC)

Standards applied:	EN 61000-6-1:2007 EN 61000-6-2:2005 EN 61000-6-3:2007 / A1:2011 / AC: 2012 EN 61000-6-4:2007 / A1: 2011
--------------------	--

Directive 2014/35/EU: Low Voltage Directive (LVD)

Standards applied:	EN 60947-1:2007 + A2:2014
--------------------	---------------------------

Directive 2011/65/EU: Restriction of the use of certain hazardous substances in electrical and electronic equipment (RoHS)

The product and all the components contained within it are in accordance with the restriction of the use of hazardous substances in electrical and electronic equipment, including amendment by Directive 2015/863/EU.

Regulation (EC) 1907/2006: Registration, Evaluation, Authorisation and Restriction of Chemicals (REACH)

The product and all the components contained within it are free from substances of very high concern.

Other Standards and Regulations

EN 60529:1992+A2:2013 - Degrees of protection provided by enclosures (IP code) – enclosure rated IP66

UKCA Declaration of Conformity



On behalf of European Safety Systems Ltd., I declare that, on the date the equipment accompanied by this declaration is placed on the market, the equipment conforms with all technical and regulatory requirements of the above listed directives, regulations and standards.

This Declaration is issued under the sole responsibility of the manufacturer.

A handwritten signature in black ink, appearing to read 'Martin Streetz'.

Martin Streetz
Quality Assurance Manager

Document No.: DC-097_Issue_A
Date and Place of Issue: London, 24/02/2022