

INSTRUCTION & SERVICE MANUAL

AL100X AlertAlight Combined Sounder Xenon Beacons

- -40°C to +66C (-40°F to 151°F)
- Type 3R / 13 (IP66, Independently tested to EN60529:1991)
- 0.46Kg (1.01lb)
- CE, UKCA, AL100XDC024 CPR compliant
- All units UL Listed.

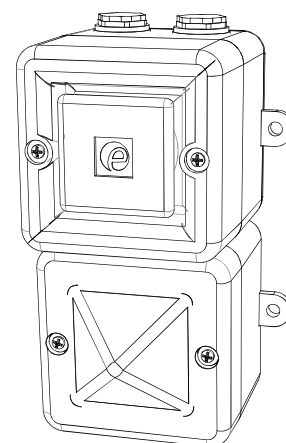

Unit Type Code	Nominal Voltage	Voltage Range	Nominal Sounder Current*	Nominal Beacon Current*	Nominal SPL	Max SPL	Average SPL
AL100XDC012	12 V dc	11.5-14V dc	17mA	500mA	101.6dB(A) Tone 44 @ 1m	110dB(A) Tone 4 @ 1m	102.3dB(A) All tones @1m
AL100XDC024	24V dc	20-28V dc	33.5mA	250mA			
AL100XDC048	48V dc	42-52V dc	113mA	170mA			
AL100XAC024	24V ac	24-28V ac 50/60Hz	42.5mA	300mA			
AL100XAC048	48V ac	48V ac ± 10% 50/60Hz	42.5mA	250mA			
AL100XAC115	115V ac	115V ac ± 10% 50/60Hz	25mA	70mA			
AL100XAC230	230V ac	230V ac ± 10% 50/60Hz	17mA	35mA			

*Nominal current at nominal voltage, Tone 12 / 1Hz Flash Pattern

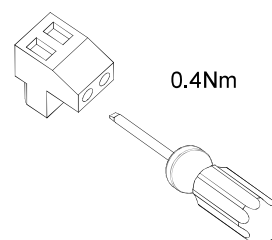
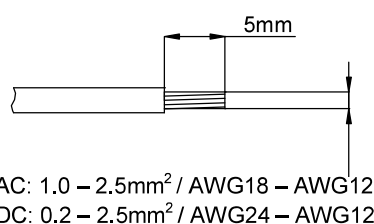

Attention: Installation must be carried out by an electrician in compliance with the latest codes and regulations.

Attention: L'installation doit être effectuée par un électricien conformément aux derniers codes et réglementations.

Achtung: Die Installation muss von einem Elektriker gemäß den neuesten Vorschriften und Bestimmungen durchgeführt werden.

Attenzione: L'installazione deve essere eseguita da un elettricista in conformità con i codici e le normative più recenti.

Atención: La instalación debe ser realizada por un electricista de acuerdo con los últimos códigos y regulaciones.

Atenção: A instalação deve ser realizada por um eletricitista de acordo com os códigos e regulamentos mais recentes.

ВНИМАНИЕ: установка должна выполняться электриком в соответствии с последними нормами и правилами.



Attention: Disconnect from power source before installation or service to prevent electric shock

Attention: Débranchez-le de la source d'alimentation avant l'installation ou l'entretien pour éviter tout choc électrique.

Achtung: Vor Installation oder Wartung von der Stromquelle trennen, um einen Stromschlag zu vermeiden.

Attenzione: scollegare dall'alimentazione prima dell'installazione o dell'assistenza per evitare scosse elettriche.

Atención: desconéctelo de la fuente de alimentación antes de la instalación o el servicio para evitar descargas eléctricas.

Atenção: Desconecte da fonte de alimentação antes da instalação ou serviço para evitar choque elétrico

ВНИМАНИЕ: отключите от источника питания перед установкой или обслуживанием, чтобы предотвратить поражение электрическим током.



AC

(See D218-06-205)

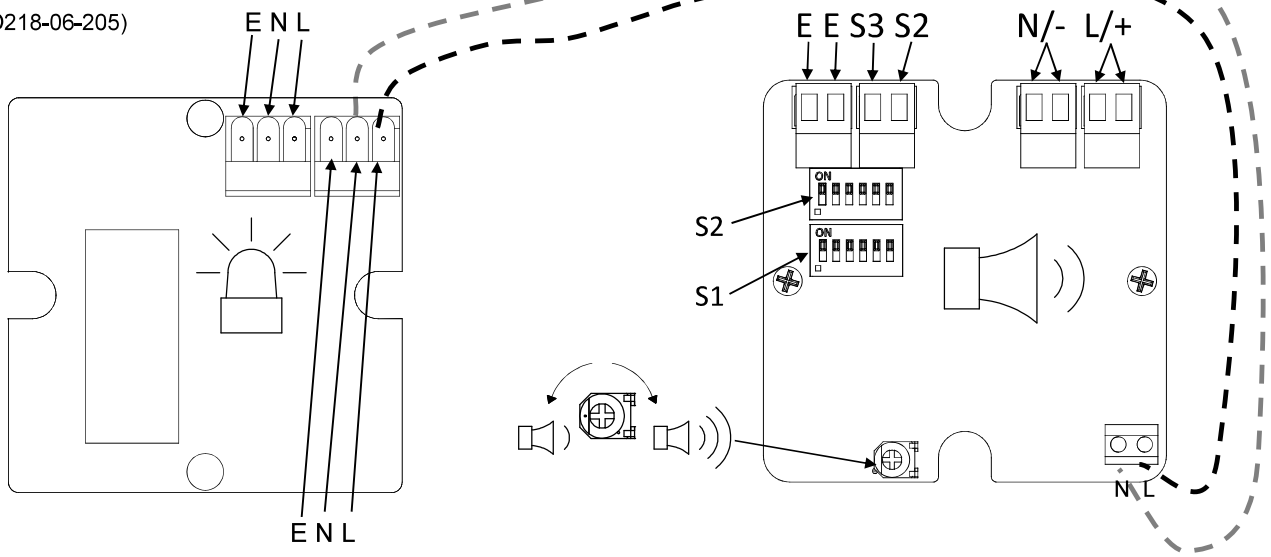

DC

(See D218-06-201)

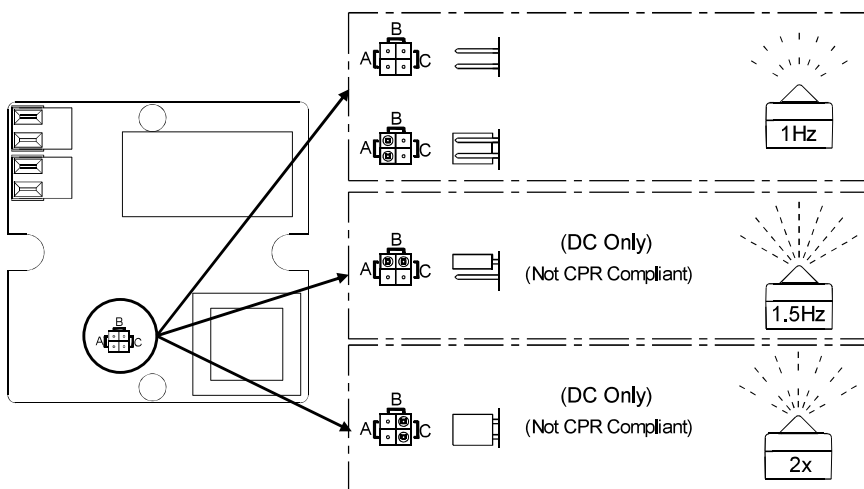
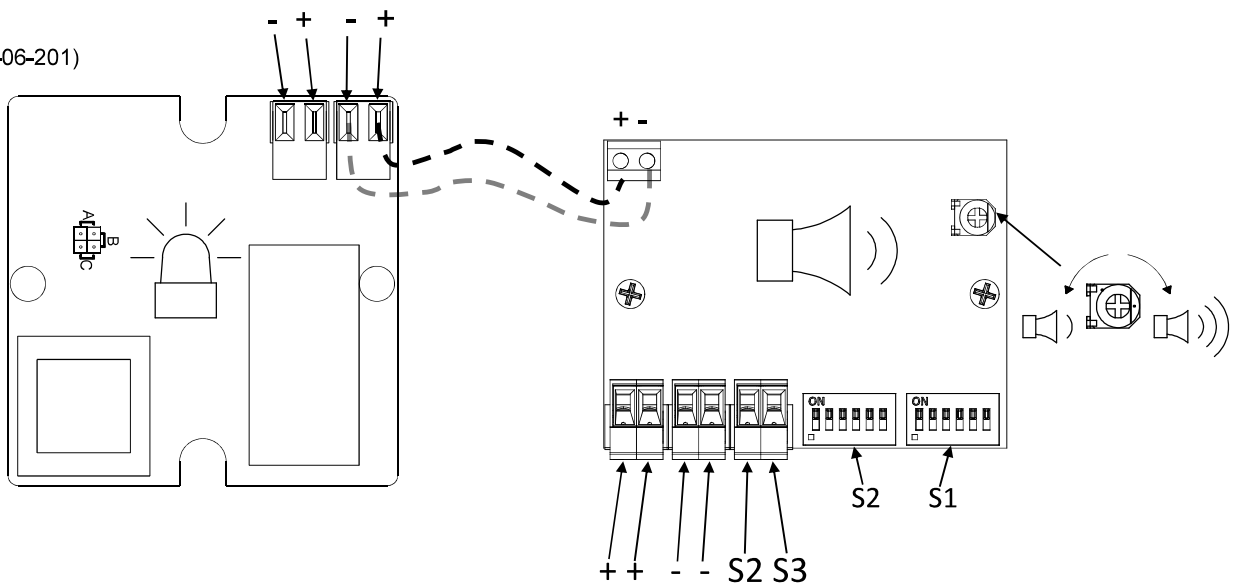

(AC & DC, See D221-95-001)

Default = S2 - Tone 1

Default = S1 - Tone 44

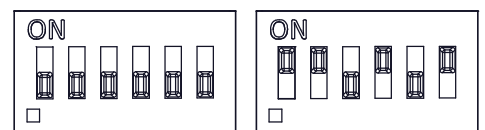

(ON = 1, OFF = 0)

INSTRUCTION & SERVICE MANUAL
AL100X AlertAlight Combined Sounder Xenon Beacons

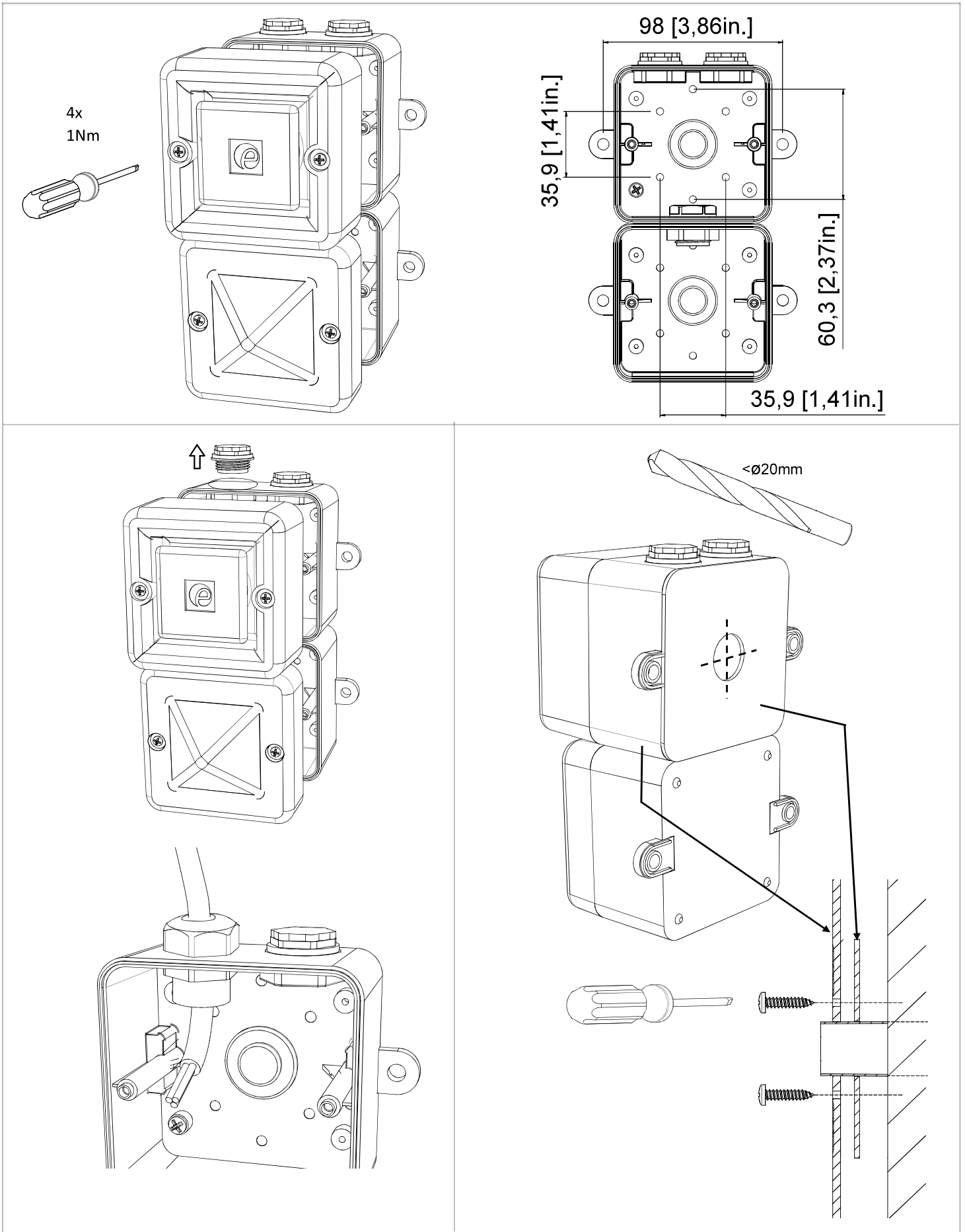

Construction Product Regulation

- AL100XDC024 & AL100XDC048 are compliant to EN54-3:2001+A1+A2 & EN54-23:2010
- VAD for use in fire detection and fire alarm systems installed in and around buildings
- Alarm devices – Sounder & Beacon
- Type 3R / 13, IP66, Independently tested to EN60529:1991, (IP33C Compliant to EN54-3)
- Type B Product, For Indoor & Outdoor use
- Observe Precautions for handling electrostatic devices
- -25°C to +55°C compliant to EN54-3 & EN54-23
- Cable Glands must be suitably sealed and meet minimum IP33 for EN54-3 applications
- Storage Temperature: -40°C to +70°C
- Maintenance – None
- Units can be mounted using the 2 of the 4-off ø6mm holes or through the back of the housing using the supplied gasket

Order Code: AL100XDC024
 Voltage Range: 20-28Vdc
 Nominal Voltage: 24Vdc
 Max Sounder Current: P1: 125mA @ 28Vdc
 Max Beacon Current: 271mA @ 20Vdc

Order Code: AL100XDC048
 Voltage Range: 42-52Vdc
 Nominal Voltage: 48Vdc
 Max Sounder Current: 125mA @ 52Vdc
 Max Beacon Current: 160mA @ 42Vdc

DOP: DP-2821-CPR-0109
 UKCA Cert: 0843-CPR-1007
 EU Cert: 2821-CPR-0109

Approved Tones for EN54-3 Applications:

- (Alternating Tone) 800/1000Hz @ 2Hz Alternating Tone 44
- (Rising Tone) 500/1200Hz @ 0.26Hz (3.3s on, 0.5s off) Tone 8
- (Fainting Tone) 1200/500Hz @ 1Hz Tone 2
- (Continuous Tone) 800Hz Tone 21
- (Pulsed Tone) 660Hz (150mS on, 150mS off) Tone 31
- (Alternating Tone) 544Hz(100mS)/440Hz (400mS) Tone 5



AL100XDC024 / AL100XDC048 @ 1m

Angle	Horizontal Sound Output Max Voltage (60 Vdc) LAFmax,T dB(A)						Horizontal Sound Output Min Voltage (18 Vdc) LAFmax,T dB(A)					
	Tone 44	Tone 8	Tone 2	Tone 21	Tone 31	Tone 5	Tone 44	Tone 8	Tone 2	Tone 21	Tone 31	Tone 5
15°	98	99.9	99	95.7	94.8	95.4	94.7	96.8	95.9	93	91.9	92.7
45°	97.8	100.1	99	97.6	94.7	96.6	95	97	96	94.8	92.1	94
75°	101.5	102.9	102.4	101.4	98.3	100.4	98.7	100.2	99.5	98.8	94.9	97.9
105°	101.4	102.8	102.5	101.4	98.1	100.4	98.6	100.2	99.5	98.8	94.9	97.9
135°	97.4	100	98.9	97.2	94.9	96.4	94.6	96.9	95.9	94.5	92.2	93.8
165°	97.5	99.6	98.9	95.8	94.7	95.4	94.3	96.4	95.8	93	91.8	92.8
Angle	Vertical Sound Output Max Voltage (60 Vdc) LAFmax,T dB(A)						Vertical Sound Output Min Voltage (18 Vdc) LAFmax,T dB(A)					
	Tone 44	Tone 8	Tone 2	Tone 21	Tone 31	Tone 5	Tone 44	Tone 8	Tone 2	Tone 21	Tone 31	Tone 5
15°	96.3	99.8	99	95.5	94.1	95.3	93.1	96.7	96	92.8	91.2	92.6
45°	97.6	99.9	98.8	97.4	94.5	96.3	94.8	96.8	95.7	94.6	91.9	93.8
75°	101.3	103	102.5	101.4	98.1	100.5	98.5	100.1	99.5	98.7	95	97.8
105°	101.3	102.8	102.4	101.3	98.2	100.5	98.5	100.1	99.5	98.7	95	97.7
135°	97.4	99.9	98.8	97.6	94.5	96.3	94.6	96.8	95.8	94.8	91.9	93.7
165°	96.7	100	99	95.5	93.9	95.4	93.6	96.9	96	92.7	91.1	92.7

INSTRUCTION & SERVICE MANUAL

AL100X AlertAlight Combined Sounder Xenon Beacons

AL100XDC024 & AL100XDC48 LIGHT OUTPUT

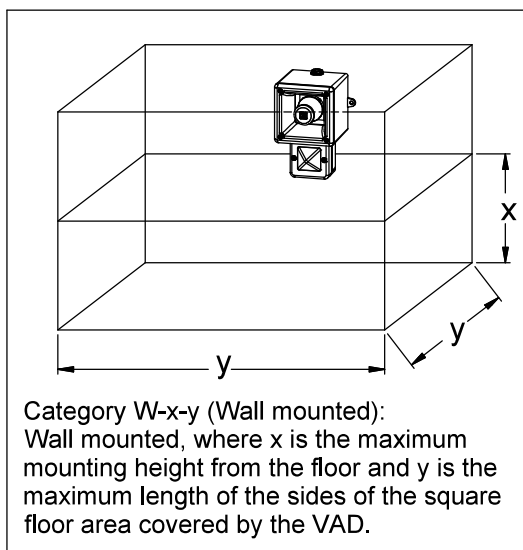

Note: CPR approved units must be positioned sounder on top, beacon below.

Coverage Area According to EN54-23
(Only units in the following table are VdS Approved)

Unit	Category W	Power
AL100XDC024	W-2.4-4.8	11W
	V=55.3m	
AL100XDC048	W-2.5-5	14W
	V=62.5m	

Approved Beacon for EN54-23 Applications:
Clear lenses are compliant with EN54-23

- All models are approved for use as Audible Signal and Visual Appliance for use as General Signaling: UL464A & CSA C22.2 No 205-17
- Type 4 / 4X / 3R / 13, IP66 independently tested to EN60529:1991
- 40°C to +66°C / -40°C to +151°F
- General Signaling Canada:
AL100XDC: -40°C to +55°C / -40°F to +131°F
AL100XAC: -40°C to +40°C / -40°F to +104°F



- To maintain Ingress Protection, cable entries must be fitted with suitably rated cable glands or stopping plugs
- Mounting - Units can be mounted using 2 of the 4-off \varnothing 6mm holes in the mounting lugs or through the back of the housing using the supplied gasket.
- EOL Monitoring (DC Only): End of Line Devices may be fitted between the +ve & -ve terminals of the PCBA. Please ensure that the device legs meet the wire size range stated for the connection terminals and are fitted correctly in order to avoid a short. Refer to the compatible control panel specification for EOL device values and ratings

Model	Nominal Voltage	Voltage Range	Nominal Operating Current*		Max Operating RMS#	
			Beacon	Sounder	Beacon	Sounder
AL100XDC012	12V dc	11.5-14Vdc	500mA	17mA	531mA	125mA
AL100XDC024	24V dc	20-28Vdc	250mA	33.5mA	271mA	
AL100XDC048	48V dc	42-54Vdc	170mA	113mA	170mA	
AL100XAC024	24V ac	24-28Vac 50/60Hz	300mA	42.5mA	426mA	42.5mA
AL100XAC048	48V ac	42-54Vac 50/60Hz	250mA	42mA	360mA	
AL100XAC115	115 Vac	103.5-126.5Vac 50/60Hz	70mA	25mA	101mA	
AL100XAC230	230 Vac	207-253Vac 50/60Hz	35mA	17mA	58mA	

*Nominal Voltage, 1Hz Flash Pattern & Tone 12; #Worst-case input voltage and worst case flash pattern



Attention: Installation must be carried out by an electrician in compliance with the National Electrical Code, NFPA 70 or CSA 22.1 Canadian Electrical Code, Part I, Safety Standard for Electrical Installations, Section 32. / L'installation doit exclusivement être réalisée par du personnel qualifié, conformément au code national d'électricité américain, NFPA 70 ou CSA 22.1 Code canadien de l'électricité, première partie, norme de sécurité relative aux installations électriques, Section 32

Stage 1 Set DIP SW 1 Tone No.	Tone Description	Tone Visual	Stage 1 & 2 DIP SW 1/2 Settings 1 2 3 4 5 6	Stage 3 Set DIP SW 1 (S3)	Stage 4 Set DIP SW 1 (S2 + S3)
1	1000Hz PFEER Toxic Gas		0 0 0 0 0	2	44
2	1200/500Hz @ 1Hz DIN /PFEER P.T.A.P.		1 0 0 0 0	3	44
3	1000Hz @ 0.5Hz(1s on, 1soff) PFEER Gen. Alarm		0 1 0 0 0 0	2	44
4	1.4KHz-1.6KHz 1s, 1.6KHz-1.4KHz 0.5s NF C 48-265		1 1 0 0 0 0	24	1
5	544Hz(100mS)/440Hz (400mS) NF S 32-001		0 0 1 0 0 0	19	1
6	1500/500Hz - (0.5s on , 0.5s off) x3 + 1s gap AS4428		1 0 1 0 0 0	44	1
7	500-1500Hz Sweeping 2 sec on 1 sec off AS4428		0 1 1 0 0 0	44	1
8	500/1200Hz @ 0.26Hz (3.3son, 0.5s off) Netherlands - NEN 2575		1 1 1 0 0 0	24	35
9	1000Hz (1s on, 1s off)x7 + (7s on, 1s off) IMO Code 1a		0 0 0 1 0 0	34	1
10	1000Hz (1s on, 1s off)x7 + (7s on, 1s off) IMO Code 1a		1 0 0 1 0 0	34	1
11	420Hz(0.5s on, 0.5s off)x3 + 1s gap ISO 8201 Temporal Pattern		0 1 0 1 0 0	1	8
12	1000Hz(0.5s on, 0.5s off)x3 + 1s gap ISO 8201 Temporal Pattern		1 1 0 1 0 0	1	8
13	422/775Hz - (0.85 on, 0.5 off) x3 + 1s gap NFPA - Temporal Coded		0 0 1 1 0 0	1	8
14	1000/2000Hz @ 1Hz Singapore		1 0 1 1 0 0	3	35
15	300Hz Continuous (f=300)		0 1 1 1 0 0	24	1
16	440Hz Continuous (f=440)		1 1 1 1 0 0	24	1
17	470Hz Continuous (f=470)		0 0 0 0 1 0	24	8
18	500Hz Continuous IMO code 2 (Low) (f=500)		1 0 0 0 1 0	24	8
19	554Hz Continuous (f=554)		0 1 0 0 1 0	24	8
20	660Hz Continuous (f=660)		1 1 0 0 1 0	24	35
21	800Hz IMO code 2 (High) (f=800)		0 0 1 0 1 0	24	35
22	1200Hz Continuous (f=1200)		1 0 1 0 1 0	24	35
23	2000Hz Continuous (f=2000)		0 1 1 0 1 0	3	35
24	2400Hz Continuous (f=2400)		1 1 1 0 1 0	20	35
25	440Hz @0.83Hz (50 cycles/minute) Intermittent (f=440, a=0.6, b=0.6)		0 0 0 1 1 0	44	8
26	470Hz @0.9Hz - 1.1s Intermittent (f=470, a=0.55, b=0.55)		1 0 0 1 1 0	44	8
27	470Hz @5Hz - (5 cycles/second) Intermittent (f=470, a=0.1, b=0.1)		0 1 0 1 1 0	44	8
28	544Hz @ 1.14Hz - 0.875s Intermittent (f=470, a=0.43, b=0.44)		1 1 0 1 1 0	24	8
29	655Hz @ 0.875Hz Intermittent (f=655, a=0.57, b=0.57)		0 0 1 1 1 0	24	8
30	660Hz @0.28Hz - 1.8sec on, 1.8sec off Intermittent (f=660, a=1.8, b=1.8)		1 0 1 1 1 0	24	8
31	660Hz @3.34Hz - 150mS on, 150mS off Intermittent (f=660, a=0.15, b=0.15)		0 1 1 1 1 0	24	8
32	745Hz @ 1Hz Intermittent (f=745, a=0.5, b=0.5)		1 1 1 1 1 0	24	8
33	800Hz - 0.25sec on, 1 sec off Intermittent (f=800, a=0.25, b=1)		0 0 0 0 0 1	24	8
34	800Hz @ 2Hz IMO code 3.a (High) Intermittent (f=800, a=0.25, b=0.25)		1 0 0 0 0 1	24	19
35	1000Hz @ 1Hz Intermittent (f=1000, a=0.5, b=0.5)		0 1 0 0 0 1	24	19
36	2400Hz @ 1Hz Intermittent (f=2400, a=0.5, b=0.5)		1 1 0 0 0 1	24	19
37	2900Hz @ 5Hz Intermittent (f=2900, a=0.1, b=0.1)		0 0 1 0 0 1	24	19
38	363/518Hz @ 1Hz Alternating (f=363, f1=518, a=0.1)		1 0 1 0 0 1	8	19
39	450/500Hz @ 2Hz Alternating (f=450, f1=500, a=0.25)		0 1 1 0 0 1	8	19
40	554/440Hz @ 1Hz Alternating (f=440, f1=554, a=0.5)		1 1 1 0 0 1	24	19
41	554/440Hz @ 0.625Hz Alternating (f=440, f1=554, a=0.8)		0 0 0 1 0 1	8	19
42	561/760Hz @0.83Hz (50 cycles/minute) Alternating (f=561, f1=760, a=0.6)		1 0 0 1 0 1	8	19
43	780/600Hz @ 0.96Hz Alternating (f=600, f1=780, a=0.52)		0 1 0 1 0 1	8	19
44	800/1000Hz @ 2Hz Alternating (f=800, f1=1000, a=0.25)		1 1 0 1 0 1	24	19
45	970/800Hz @ 2Hz Alternating (f=800, f1=970, a=0.25)		0 0 1 1 0 1	8	19
46	800/1000Hz @ 0.875Hz Alternating (f=800, f1=1000, a=0.57)		1 0 1 1 0 1	24	19
47	2400/2900Hz @ 2Hz Alternating (f=2400, f1=2900, a=0.25)		0 1 1 1 0 1	24	19
48	500/1200Hz @ 0.3Hz Sweeping (f=500, f1=1200, a=3.34)		1 1 1 1 0 1	24	12
49	560/1055Hz @ 0.18Hz Sweeping (f=560, f1=1055, a=5.47)		0 0 0 0 1 1	24	12
50	560/1055Hz @ 3.3Hz Sweeping (f=560, f1=1055, a=0.3)		1 0 0 0 1 1	24	12
51	600/1250Hz @ 0.125Hz Sweeping (f=600, f1=1250, a=8)		0 1 0 0 1 1	24	12
52	660/1200Hz @ 1Hz Sweeping (f=660, f1=1200, a=1)		1 1 0 0 1 1	24	12
53	800/1000Hz @ 1Hz Sweeping (f=800, f1=1000, a=1)		0 0 1 0 1 1	24	12
54	800/1000Hz @ 7Hz Sweeping (f=800, f1=1000, a=0.14)		1 0 1 0 1 1	24	12
55	800/1000Hz @ 50Hz Sweeping (f=800, f1=1000, a=0.02)		0 1 1 0 1 1	24	12
56	2400/2900Hz @ 7Hz Sweeping (f=2400, f1=2900, a=0.14)		1 1 1 0 1 1	24	12
57	2400/2900Hz @ 1Hz Sweeping (f=2400, f1=2900, a=1)		0 0 0 1 1 1	24	12
58	2400/2900Hz @ 50Hz Sweeping (f=2400, f1=2900, a=0.02)		1 0 0 1 1 1	24	12
59	2500/3000Hz @ 2Hz Sweeping (f=2500, f1=3000, a=0.5)		0 1 0 1 1 1	24	12
60	2500/3000Hz @ 7.7Hz Sweeping (f=2500, f1=3000, a=0.13)		1 1 0 1 1 1	24	12
61	800Hz Motor Siren (f=800, a=1.6)		0 0 1 1 1 1	24	12
62	1200Hz Motor Siren (f=1200, a=2)		1 0 1 1 1 1	24	12
63	2400Hz Motor Siren (f=2400, a=1.7)		0 1 1 1 1 1	24	12
64	Simulated Bell		1 1 1 1 1 1	21	12

FIRE INSTRUCTION & SERVICE MANUAL

AL100X Range AlertAight Combined Sounder Xenon Beacons

UL464 / CAN/ULC-S525 & UL1638 / CAN/ULC-S526

Model: AL100XDC



Attention: Installation must be carried out by an electrician in compliance with the National Electrical Code, NFPA 70, and the National Fire Alarm Signaling Code, NFPA 72 or CSA 22.1 Canadian Electrical Code, Part I, Safety Standard for Electrical Installations, Section 32. / L'installation doit exclusivement être réalisée par du personnel qualifié, conformément au code national d'électricité américain, NFPA 70, et le code national d'alarme incendie et de signalisation NFPA 72 ou CSA 22.1 Code canadien de l'électricité, première partie, norme de sécurité relative aux installations électriques, Section 32



Attention: Disconnect from power source before installation or service to prevent electric shock / Débranchez-le de la source d'alimentation avant l'installation ou l'entretien pour éviter tout choc électrique.



Attention: Do not paint / Ne pas Peinturer

- -40°C to +66°C / -40°F to +151°F
- Units can be mounted using the 2-off ø6mm holes in the mounting lugs or through the back of the housing using the supplied gasket seal.
- AL100XDC024 is approved for use as an Audible & Visual signal appliance for fire alarm use – Private Mode & Emergency Warning. (UL464 & CAN/ULC-S525 & UL1638 & CAN/ULC-S526).
- AL100XDC024 produces a minimum sound pressure level of US: 79.55dB(A); CA: 85.2dB(A) at 10 feet (figures @ worst case 10Vdc).
- AL100XDC024 produces a minimum sound pressure level of US: 88.52dB(A); CA: 93.7dB(A) at 10 feet (@24Vdc)
- For Fire Alarm applications, the Sounder Volume must be at the highest setting, (see volume control section). For fire alarm use, Tone 12 as shown below must be selected:

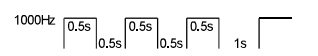
Stage 1 Set DIP SW 1 Tone No.	Tone Description	Tone Visual	Stage 1 & 2 DIP SW 1/2 Settings 1 2 3 4 5 6	Stage 3 Set DIP SW 1 (S3)	Stage 4 Set DIP SW 1 (S2 + S3)
12	1000Hz(0.5s on, 0.5s off)x3 + 1s gap ISO 8201 Temporal Pattern		1 1 0 1 0 0	1	8

- For private mode fire alarm and Emergency Warning use, the beacons must be set to the certified flash patterns of 1Hz.
- For light output ratings see below:

On-axis light output rating per UL1638 & Emergency Warning

Model	Lens Colour	UL1638 Intensity (cd) at 1Hz flash rate	Emergency Warning Intensity (cd) at 1Hz
AL100XDC024	Clear	86.5	69.2
	Amber	38.12	30.5
	Blue	11.75	-
	Green	32.62	26.1
	Magenta	11.75	-
	Red	8.62	-
	Yellow	77.0	61.6

- Connection Terminals: Pluggable
AC: 1.0 - 2.5mm² / AWG18 - AWG12
DC: 0.2 - 2.5mm² / AWG24 - AWG12
- Terminal Tightening torque 0.4Nm
- To maintain Ingress Protection, cable entries must be fitted with suitably rated cable glands or stopping plugs
- Units can be located indoor or outdoor wet use, wall or ceiling mounted and there are no limitations on orientation
- Factory finishes are not intended to be modified

Surge current ratings for use in fire alarm systems

Model	Nominal Voltage	Voltage Range	Flash Rate	Initial Peak (mA)		Initial RMS (mA)	
				Beacon	Sounder	Beacon	Sounder
AL100XDC024	24Vdc	20 to 28Vdc	1Hz	271	298	250	56.4

AL100XDC024 Sounder Directional Characteristics for Canadian Fire CAN/ULC-S525 at 10 feet

Horizontal Axis				Vertical Axis			
Angle	OSPL	Angle	OSPL	Angle	OSPL	Angle	OSPL
Ref. 90°	92.6 dB(A)	Ref. 90°	92.6 dB(A)	Ref. 90°	93 dB(A)	Ref. 90°	93 dB(A)
149°	-3 dB(A)	32°	-3 dB(A)	148°	-3 dB(A)	33°	-3 dB(A)
153°	-6 dB(A)	28°	-6 dB(A)	151.5°	-6 dB(A)	29°	-6 dB(A)
180°	87.2 dB(A)	0°	87 dB(A)	180°	87.2 dB(A)	0°	86.4 dB(A)

AL100XDC024 Sounder PCBA

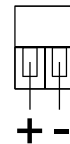
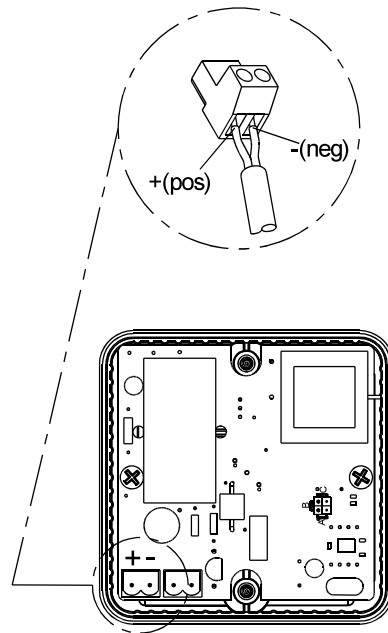
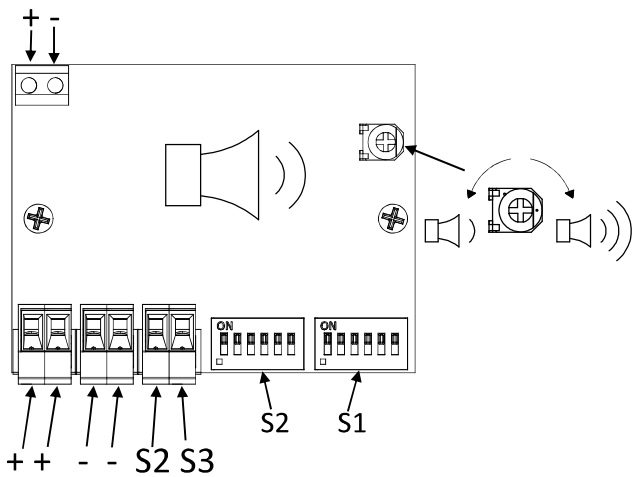

AL100XDC024 Beacon PCBA
20-28 VDC

Header Pin Settings for Flashing modes

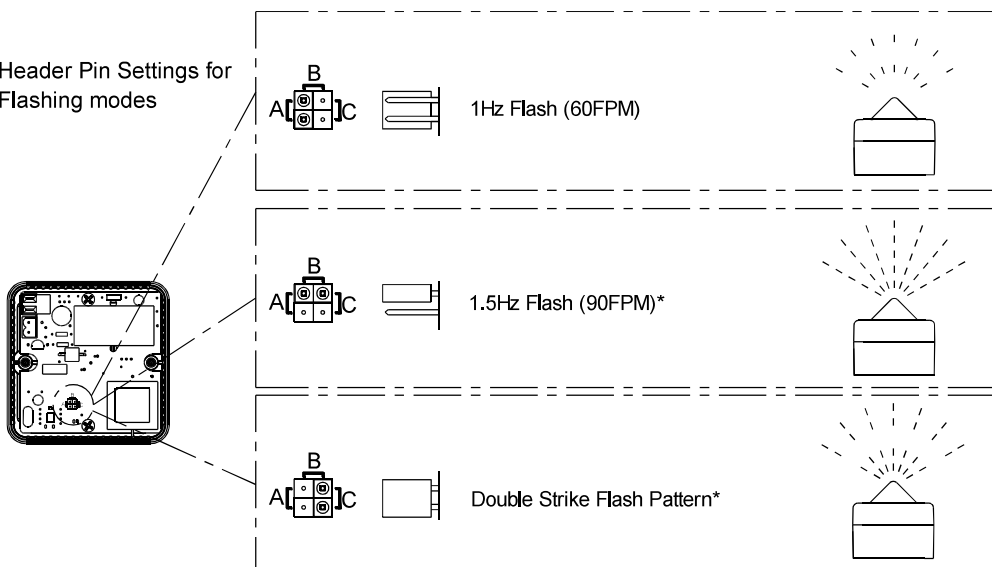

*Flash Modes not tested to UL1638 / CAN/ULC-S526

1	2	3	4	5	6	7	8	9	10
<p>OPTIONAL LINE MONITORING RESISTOR, CUSTOMER SUPPLIED. RECOMMENDED MINIMUM VALUES: 14V MAX SYSTEM = 120Ω MIN, 2W MIN OR 1KΩ MIN, 0.5W MIN 28V MAX SYSTEM = 470Ω MIN, 2W MIN OR 2.4KΩ MIN, 0.5W MIN</p>		<p>WIRING LINKING BEACON & SOUNDER FACTORY FITTED</p>		<p>ISSUE MOD No. REASON - INITIAL - DATE</p> <p>A RSR - 11/05/2021</p> <p>B AMENDED NOTES 1b & 1c RSR - 24/01/2023</p>					







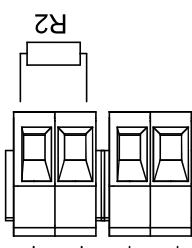
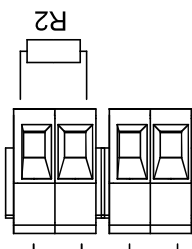
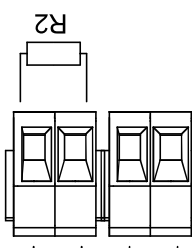
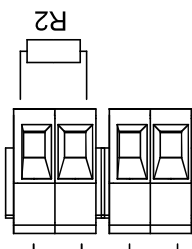
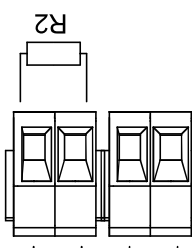
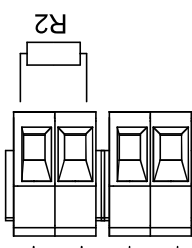
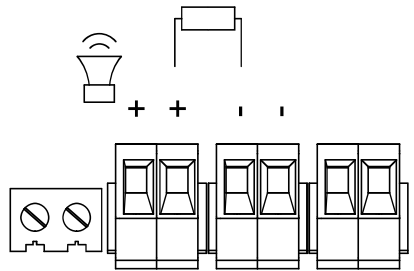
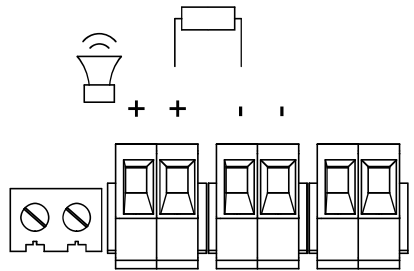
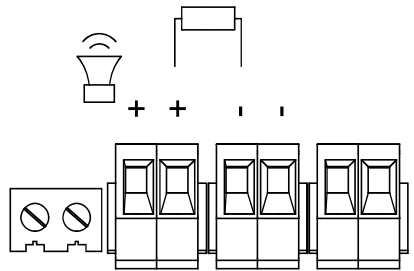
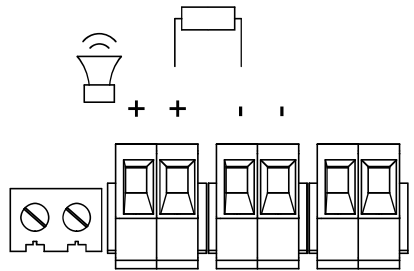

Linked Sounder & Beacon Activation (Default)

<p>Single Stage Configuration Line Monitoring</p>	<p>Config.: 1a</p>	<p>Two Stage Configuration Common Positive</p>	<p>Config.: 1b</p>	<p>Three/Four Stage Configuration Common Positive</p>	<p>Config.: 1c</p>
<p>Stage 1: Apply Power to Stage 1 +ve & Stage 1 -ve</p>	<p>Stage 1: Apply Power to Common +ve & Stage 1 -ve Stage 2: Apply Power to Common +ve & Stage 1 -ve & connect Stage 2 -ve to Stage 1 -ve</p>	<p>Stage 1: Apply Power to Common +ve & Stage 1 -ve Stage 2: Apply Power to Common +ve & Stage 1 -ve & connect Stage 2 -ve to Stage 1 -ve</p>	<p>Stage 1: Apply Power to Common +ve & Stage 1 -ve Stage 2: Apply Power to Common +ve & Stage 1 -ve & connect Stage 2 -ve to Stage 1 -ve Stage 3: Apply Power to Common +ve & Stage 1 -ve & connect Stage 3 -ve to Stage 1 -ve Stage 4: Apply Power to Common +ve & Stage 1 -ve & connect Stage 2 -ve & Stage 3 -ve to Stage 1 -ve</p>	<p>Stage 1: Apply Power to Common +ve & Stage 1 -ve Stage 2: Apply Power to Common +ve & Stage 1 -ve & connect Stage 2 -ve to Stage 1 -ve Stage 3: Apply Power to Common +ve & Stage 1 -ve & connect Stage 3 -ve to Stage 1 -ve Stage 4: Apply Power to Common +ve & Stage 1 -ve & connect Stage 2 -ve & Stage 3 -ve to Stage 1 -ve</p>	<p>Stage 1: Apply Power to Common +ve & Stage 1 -ve Stage 2: Apply Power to Common +ve & Stage 1 -ve & connect Stage 2 -ve to Stage 1 -ve Stage 3: Apply Power to Common +ve & Stage 1 -ve & connect Stage 3 -ve to Stage 1 -ve Stage 4: Apply Power to Common +ve & Stage 1 -ve & connect Stage 2 -ve & Stage 3 -ve to Stage 1 -ve</p>
<p>Stage 1 +ve IN Stage 1 +ve OUT Stage 1 -ve OUT Stage 1 -ve IN</p>	<p>Common +ve IN Common +ve OUT Stage 1 -ve OUT Stage 1 -ve IN Stage 2 -ve</p>	<p>Common +ve IN Common +ve OUT Stage 1 -ve OUT Stage 1 -ve IN Stage 2 -ve</p>	<p>Common +ve IN Common +ve OUT Stage 1 -ve OUT Stage 1 -ve IN Stage 2 -ve Stage 3 -ve Stage 3</p>	<p>Common +ve IN Common +ve OUT Stage 1 -ve OUT Stage 1 -ve IN Stage 2 -ve Stage 3 -ve Stage 3</p>	<p>Common +ve IN Common +ve OUT Stage 1 -ve OUT Stage 1 -ve IN Stage 2 -ve Stage 3 -ve Stage 3</p>

<p>DRAWING TO BS8888:2000 GEOMETRIC TOLERANCES TO ISO1101:1983 LINEAR DIMENSIONAL TOLS ANGULAR DIMENSIONAL TOLS</p>	<p>DRAWN R.S. RAIT CHECKED B. ISARD APPROVED R.N. POTTS</p>	<p>DATE 16/03/2021 DATE 16/03/2021 DATE 16/03/2021</p>	<p>SURFACE FINISH WEIGHT (kg) MATERIAL ALTERNATIVE MATERIAL</p>	<p>THIS DRAWING AND ANY INFORMATION OR DESCRIPTIVE MATTER THEREIN IS COMMUNICATED IN CONFIDENCE AND IS THE PROPERTY OF EUROPEAN SAFETY SYSTEMS LTD. NEITHER THE WHOLE OR ANY EXTRACT MAY BE DISCLOSED, LOANED, COPIED OR USED FOR MANUFACTURING OR TENDERING PURPOSES WITHOUT THEIR WRITTEN CONSENT. © EUROPEAN SAFETY SYSTEMS LTD. AS PER LATEST DATE OF ISSUE SHOWN ABOVE</p>	<p>EUROPEAN SAFETY SYSTEMS LTD MANUFACTURING HOUSE LONDON W3 7QH WWW.ESS.COM</p>	<p>ALL DIMENSIONS IN MM IF IN DOUBT, ASK - DO NOT SCALE</p> <p>TITLE AL100X, AL105NX & DL105X DC COMBINED SOUNDER & XENON WIRING DIAGRAMS</p> <p>SCALE NTS SHEET 1 OF 2 DRAWING NUMBER D218-06-201</p>	<p>A3</p>
---	---	--	---	---	--	--	-----------

1	2	3	4	5	6	7	8	9	10
<p>OPTIONAL LINE MONITORING RESISTOR, CUSTOMER SUPPLIED, RECOMMENDED MINIMUM VALUES: 14V MAX SYSTEM = 120Ω MIN, 2W MIN OR 1KΩ MIN, 0.5W MIN 28V MAX SYSTEM = 470Ω MIN, 2W MIN OR 2.4KΩ MIN, 0.5W MIN</p>									
<p>ISSUE MOD No. REASON - INITIAL - DATE</p> <p>A RSR - 11/05/2021</p> <p>B AMENDED NOTES 1b & 1c RSR - 24/01/2023</p>									

Independent Sounder & Beacon Activation (Remove Link Wires)

<p>Single Stage Configuration Line Monitoring</p>	<p>Config.: 5a</p>	<p>Two Stage Configuration Common Positive</p>	<p>Config.: 5b</p>	<p>Three/Four Stage Configuration Common Positive</p>	<p>Config.: 5c</p>
<p>Stage 1: Apply Power to Stage 1 +ve & Stage 1 -ve</p>	<p>Stage 1: Apply Power to Common +ve & Stage 1 -ve Stage 2: Apply Power to Common +ve & Stage 1 -ve & connect Stage 2 -ve to Stage 1 -ve</p>	<p>Stage 1: Apply Power to Common +ve & Stage 1 -ve Stage 2: Apply Power to Common +ve & Stage 1 -ve & connect Stage 2 -ve to Stage 1 -ve</p>	<p>Stage 1: Apply Power to Common +ve & Stage 1 -ve Stage 2: Apply Power to Common +ve & Stage 1 -ve & connect Stage 2 -ve to Stage 1 -ve Stage 3: Apply Power to Common +ve & Stage 1 -ve & connect Stage 3 -ve to Stage 1 -ve Stage 4: Apply Power to Common +ve & Stage 1 -ve & connect Stage 2 -ve & Stage 3 -ve to Stage 1 -ve</p>	<p>Stage 1: Apply Power to Common +ve & Stage 1 -ve Stage 2: Apply Power to Common +ve & Stage 1 -ve & connect Stage 2 -ve to Stage 1 -ve Stage 3: Apply Power to Common +ve & Stage 1 -ve & connect Stage 3 -ve to Stage 1 -ve Stage 4: Apply Power to Common +ve & Stage 1 -ve & connect Stage 2 -ve & Stage 3 -ve to Stage 1 -ve</p>	<p>Stage 1: Apply Power to Common +ve & Stage 1 -ve Stage 2: Apply Power to Common +ve & Stage 1 -ve & connect Stage 2 -ve to Stage 1 -ve Stage 3: Apply Power to Common +ve & Stage 1 -ve & connect Stage 3 -ve to Stage 1 -ve Stage 4: Apply Power to Common +ve & Stage 1 -ve & connect Stage 2 -ve & Stage 3 -ve to Stage 1 -ve</p>
<p>-ve IN +ve IN -ve OUT +ve OUT</p> 	<p>-ve IN +ve IN -ve OUT +ve OUT</p> 	<p>-ve IN +ve IN -ve OUT +ve OUT</p> 	<p>-ve IN +ve IN -ve OUT +ve OUT</p> 	<p>-ve IN +ve IN -ve OUT +ve OUT</p> 	<p>-ve IN +ve IN -ve OUT +ve OUT</p> 
<p>Stage 1 +ve IN Stage 1 +ve OUT Stage 1 -ve OUT Stage 1 -ve IN</p> 	<p>Common +ve IN Common +ve OUT Stage 1 -ve OUT Stage 1 -ve IN</p> 	<p>Common +ve IN Common +ve OUT Stage 1 -ve OUT Stage 1 -ve IN</p> 	<p>Common +ve IN Common +ve OUT Stage 1 -ve OUT Stage 1 -ve IN</p> 	<p>Common +ve IN Common +ve OUT Stage 1 -ve OUT Stage 1 -ve IN</p> 	<p>Common +ve IN Common +ve OUT Stage 1 -ve OUT Stage 1 -ve IN</p> 
<p>Stage 2 -ve Stage 3 -ve</p> 	<p>Stage 2 -ve</p> 	<p>Stage 2 -ve Stage 3 -ve</p> 	<p>Stage 2 -ve</p> 	<p>Stage 2 -ve Stage 3 -ve</p> 	<p>Stage 2 -ve Stage 3 -ve</p> 

<p>DRAWING TO BS8888:2000 GEOMETRIC TOLERANCES TO ISO1101:1983 LINEAR DIMENSIONAL TOLS ANGULAR DIMENSIONAL TOLS</p>	<p>DRAWN R.S. RAIT CHECKED B. ISARD APPROVED R.N. POTTS</p>	<p>DATE 16/03/2021 DATE 16/03/2021 DATE 16/03/2021</p>	<p>SURFACE FINISH WEIGHT (kg) MATERIAL ALTERNATIVE MATERIAL</p>	<p>THIS DRAWING AND ANY INFORMATION OR DESCRIPTIVE MATTER THEREIN IS COMMUNICATED IN CONFIDENCE AND IS NOT TO BE REPRODUCED, COPIED, EITHER WHOLLY OR IN PART, OR BY ANY MEANS, WITHOUT THE WRITTEN CONSENT OF EUROPEAN SAFETY SYSTEMS LTD.</p>	<p>EUROPEAN SAFETY SYSTEMS LTD MARKET HOUSE LONDON W3 7QH WWW.ES2S.COM</p>	<p>ALL DIMENSIONS IN MM IF IN DOUBT, ASK - DO NOT SCALE</p>	<p>A3 TITLE AL100X, AL105NX & DL105X DC COMBINED SOUNDER & XENON WIRING DIAGRAMS</p>	<p>SCALE SHEET NTS 2 OF 2 DRAWING NUMBER D218-06-201</p>	<p>STANDARDS ALERTALARM RANGE</p>
---	---	--	---	---	--	---	--	--	-----------------------------------

Linked Sounder & Beacon Activation (Default)

Config.: 1b

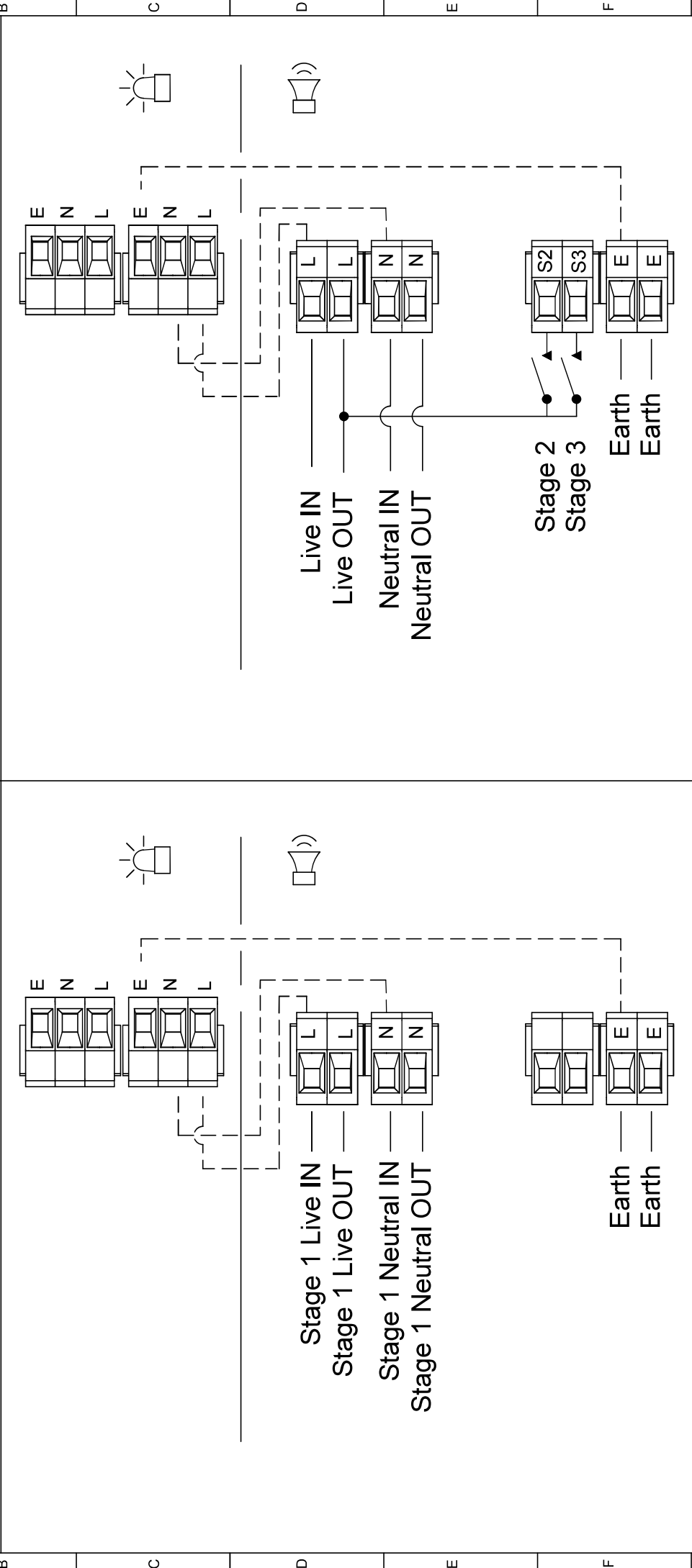

DRAWING TO BS8888:2000 GEOMETRIC TOLERANCES TO ISO1101:1983 LINEAR DIMENSIONAL TOLS ANGULAR DIMENSIONAL TOLS	DRAWN	DATE	SURFACE FINISH	WEIGHT (kg)
	R.S.RAIT	16/03/2021	MATERIAL	
STANDARDS ALERTALARM RANGE	CHECKED	DATE	ALTERNATIVE MATERIAL	
	B.ISARD	16/03/2021		
	APPROVED	DATE		
	R.N.POTTS	16/03/2021		

e2s
Warning signals

EUROPEAN SAFETY SYSTEMS LTD
 THE HOUSE
 MANES ROAD
 ACTON
 LONDON W3 7QH
 WWW.E2S.COM

THIS DRAWING AND ANY INFORMATION OR DESCRIPTIVE MATTER THEREIN IS COMMUNICATED IN CONFIDENCE AND IS THE PROPERTY OF EUROPEAN SAFETY SYSTEMS LTD. NEITHER THE WHOLE OR ANY EXTRACT MAY BE DISCLOSED, LOANED, COPIED OR USED FOR MANUFACTURING OR TENDERING PURPOSES WITHOUT THEIR WRITTEN CONSENT.

© EUROPEAN SAFETY SYSTEMS LTD.
AS PER LATEST DATE OF ISSUE SHOWN ABOVE

ALL DIMENSIONS IN MM IF IN DOUBT, ASK - DO NOT SCALE		A3
TITLE AL100X, AL105NX & DL105X COMBINED SOUNDER & XENON WIRING DIAGRAMS		
SCALE	SHEET	DRAWING NUMBER
NTS	1 OF 2	D218-06-205

Independent Sounder & Beacon Activation (Remove Link Wires)

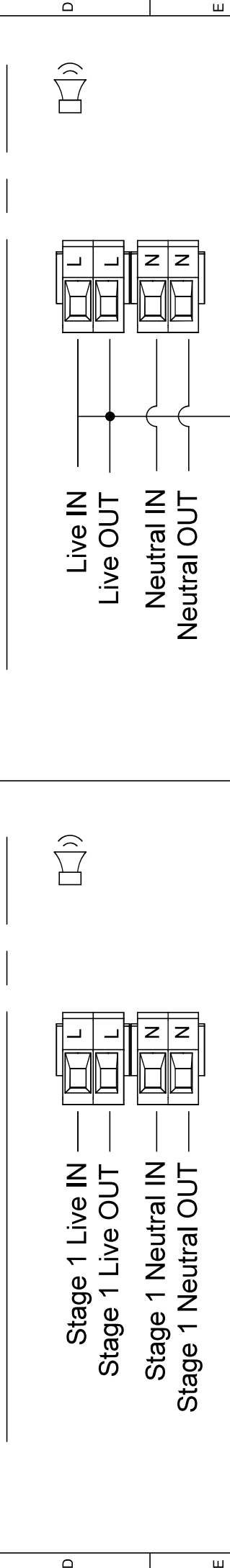
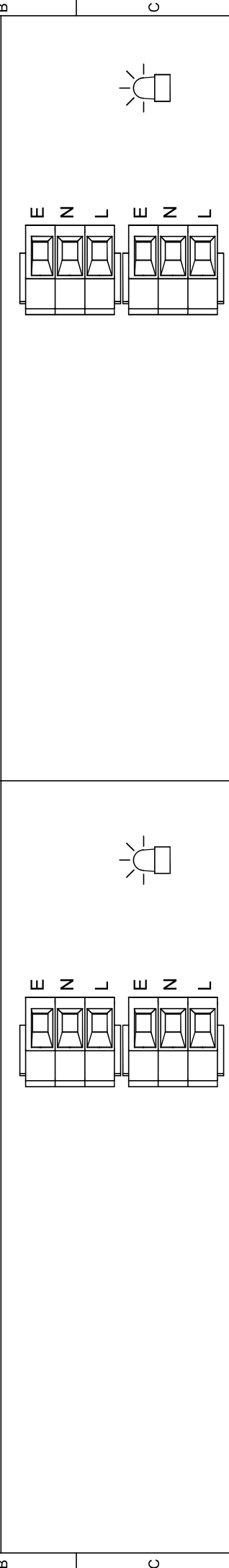

DRAWING TO BS8888:2000 GEOMETRIC TOLERANCES TO ISO1101:1983 LINEAR DIMENSIONAL TOLS ANGULAR DIMENSIONAL TOLS	DRAWN	DATE	SURFACE FINISH	WEIGHT (kg)
	R.S.RAIT	16/03/2021	MATERIAL	
STANDARDS ALERTALARM RANGE	CHECKED	DATE	ALTERNATIVE MATERIAL	
	B.ISARD	16/03/2021		
	APPROVED	DATE		
	R.N.POTTS	16/03/2021		

A

B

C

D

E

F

G