



TL23105C

European Safety Systems Limited

Ingress Protection

EN 60529: 1992 + A2: 2013 (IP66, IPX7 and IPX8)

**Dual Action Push Button Manual Call Point
GNExCP7-PB**

19th September 2023

Contents

1	SCOPE OF WORK	3
2	EQUIPMENT UNDER TEST	3
3	TEST LABORATORY	5
4	TEST SPECIFICATION, METHODS AND PROCEDURES	6
4.1	TEST DETAILS.....	6
4.2	TEST PROCEDURES.....	6
5	OPERATION OF THE EUT DURING TESTING	7
5.1	SYSTEM CONFIGURATION.....	7
5.2	ACCEPTANCE CRITERIA.....	8
6	TEST RESULTS	9
6.1	SAMPLES.....	9
6.2	SUMMARY OF TEST RESULTS.....	10
6.3	EQUIPMENT PERFORMANCE.....	10
6.4	IP6X.....	11
6.5	IPX6.....	16
6.6	IPX7.....	23
6.7	IPX8.....	28

1 SCOPE OF WORK

Test requirements

This file contains the results of tests carried out to meet the requirements of EN 60529: 1992 + A2: 2013 (IP66, IPX7 and IPX8).

2 EQUIPMENT UNDER TEST

The tests were performed only on the sample shown below:

Description	The EUT is a dual action push button manual call point for hazardous areas.
--------------------	---

Item	Model	Unique Identifier
Manual Call Point – Sample 1	GNE _x CP7-PB	001
Manual Call Point – Sample 2	GNE _x CP7-PB	002
Manual Call Point – Sample 3	GNE _x CP7-PB	003
Manual Call Point – Sample 4	GNE _x CP7-PB	004

All model numbers and unique identifiers were supplied by the client or taken from the supplied EUT. The sample tested was selected and provided by the client. The laboratory did not sample the selected EUT.

The client stated that the unit tested forms part of a range of products that share the same IP housing. It was decided that testing only one product from the range was necessary as the unit enclosures are identical and the only difference is the internal electronics. This report is only for the model tested.

The following models are units within this range. Only the GNE_xCP7-PB was tested. – GNE_xCP7-PB, GNE_xCP7-PT, GNE_xCP7-PM, WP7-PB, WP7-PT and WP7-PM form the range of identical units.

Date of Receipt	3 rd August 2023
------------------------	-----------------------------

Date of Testing	11 th September 2023 – 15 th September 2023
------------------------	---

Client: European Safety Systems Limited
Unit B Impress House
Mansell Road Acton
London
W3 7QH

Contact: Mr Randip Rait

Email: Randip.raita@e2s.com

Telephone Number: 020 3470 0135

Test Results

The equipment under test complied with the requirements of the specification. This test report may not be reproduced in whole or part without the prior written approval of the laboratory. The test results in this report are facts and any opinions or interpretations derived from these facts shall be marked *

Signed



Mr. Stephen Lee
Laboratory Manager

3 TEST LABORATORY

The tests were carried out at MS Testing, located in Newton Aycliffe, Co. Durham, UK.

Laboratory accreditation:

MS Testing is UKAS Accredited Test Laboratory No. 4413.

Ambient conditions in the laboratory:

PARAMETER	Required (Lloyd's Specification 1)
Temperature °C	15 – 35
Humidity % RH	42 – 78
Barometric pressure mbar	860 - 1060

4 TEST SPECIFICATION, METHODS AND PROCEDURES

4.1 Test Details

The tests detailed in this file are –

	Test	Basic Standard
6.4	Ingress Protection 6X (IP6X)	EN 60529: 1992 + A2: 2013
6.5	Ingress Protection X6 (IPX6)	EN 60529: 1992 + A2: 2013
6.6	Ingress Protection X7 (IPX7)	EN 60529: 1992 + A2: 2013
6.7	Ingress Protection X8 (IPX8)	EN 60529: 1992 + A2: 2013

4.2 Test Procedures

IP6X

The enclosure under test is supported inside the test chamber and the pressure inside the enclosure is maintained below the surrounding atmospheric pressure by a vacuum pump. The suction connection shall be made to a hole specially provided for this test. If not otherwise specified in the relevant product standard, this hole shall be in the vicinity of the vulnerable parts. If it is impracticable to make a special hole, the suction connection shall be made to the cable inlet hole. If there are other holes (e.g., more cable inlet holes or drain-holes) these shall be treated as intended for normal use on site. The object of the test is to draw into the enclosure, by means of depression, a volume of air 80 times the volume of the sample enclosure tested without exceeding the extraction rate of 60 volumes per hour. In no event shall the depression exceed 2 kPa (20 mbar) on the manometer. If an extraction rate of 40 to 60 volumes per hour is obtained the duration of the test is 2 h. If, with a maximum depression of 2kPa (20 mbar), the extraction rate is less than 40 volumes per hour, the test is continued until 80 volumes have been drawn through, or a period of 8 h has elapsed.

IPX6

The enclosure under test is sprayed from all practical directions at a distance of 2500mm to 3000mm with water through a 12.5mm nozzle at a water pressure of 100 litres/min. The equipment under test is sprayed for a period of no less than 3 minutes at each direction.

IPX7

The enclosure under test is placed in its normal operating orientation into a tank filled with water to a depth of 1 metre for 30 minutes.

IPX8

The enclosure under test is placed in its normal operating orientation into a pressure vessel and submerged in 200mm of water, the vessel is pressurised so that the EUT experiences the pressure associated with a depth of 35m for 40 hours.

5 OPERATION OF THE EUT DURING TESTING

5.1 System Configuration

The equipment was not powered during any of the testing, the enclosure was checked after the test for ingress as applicable.

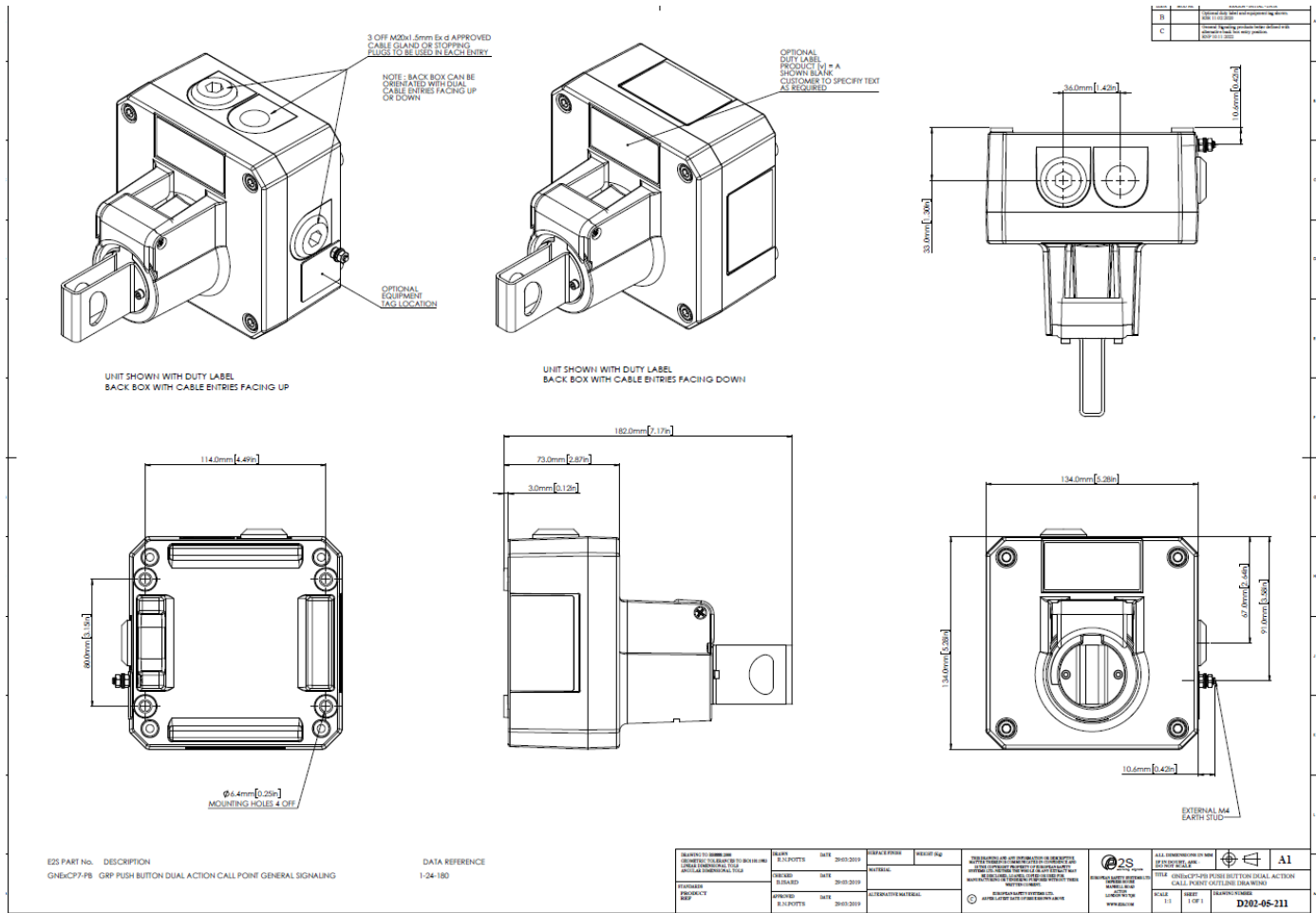

5.2 Acceptance Criteria

IP6X

No dust shall enter the enclosure.

IPX6, IPX7 and IPX8

No water shall enter the enclosure that will either impair safety or correct operation given in the acceptance criterion of the standard.

6 TEST RESULTS

6.1 Samples

All of the samples tested were original samples with no modifications.

6.2 Summary of test results

Basic Standard	Test	Result	Sample
EN 60529	Ingress Protection IP6X	Complied	1
EN 60529	Ingress Protection IPX6	Complied	1
EN 60529	Ingress Protection IPX7	Complied	1
EN 60529	Ingress Protection IPX8	Complied	1

6.3 Equipment Performance

Specification

The conformance to drawings is checked and a functional performance test is demonstrated to ensure that the system operates in accordance with the customer's instructions where applicable.

Test Procedure

The equipment was checked to ensure it was sealed as the customer required it and to the correct torque.

6.4 IP6X

Basic Standard:	EN 60529: 1992 + A2: 2013
Applicability:	Enclosure

Test Result

The enclosure under test was supported inside the test chamber and the pressure inside the enclosure was maintained below the surrounding atmospheric pressure by a vacuum pump.

The extraction rate was less than 40 volumes per hour, so the test was continued for a period of 8 h.

No dust was found to have entered the enclosure.

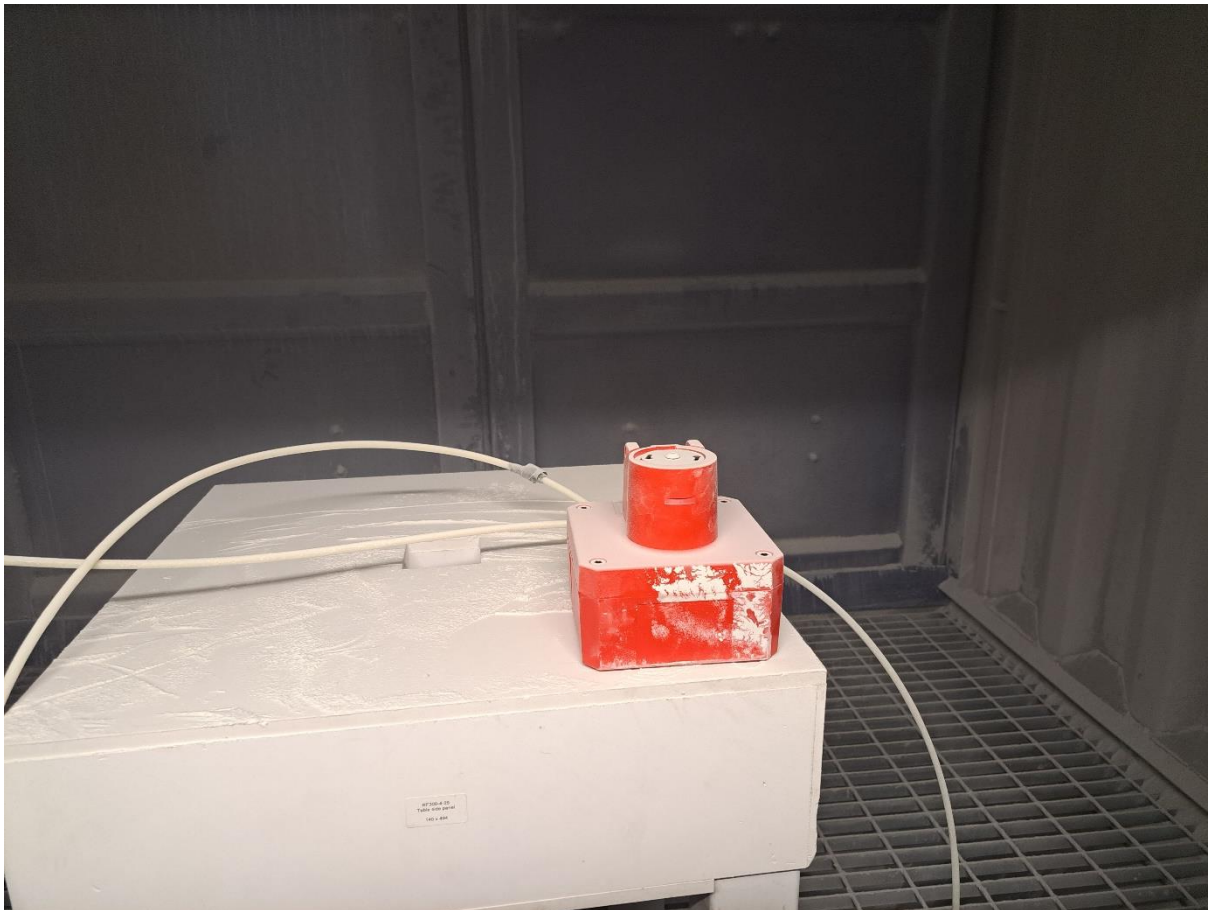

Test Results

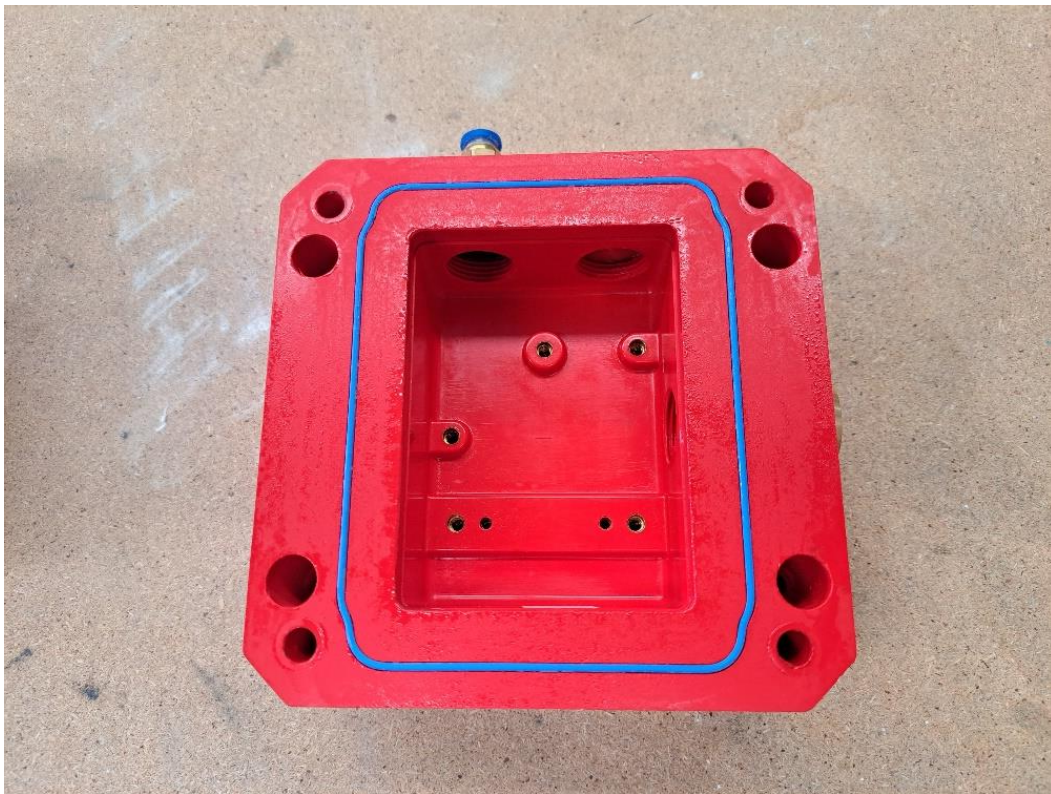
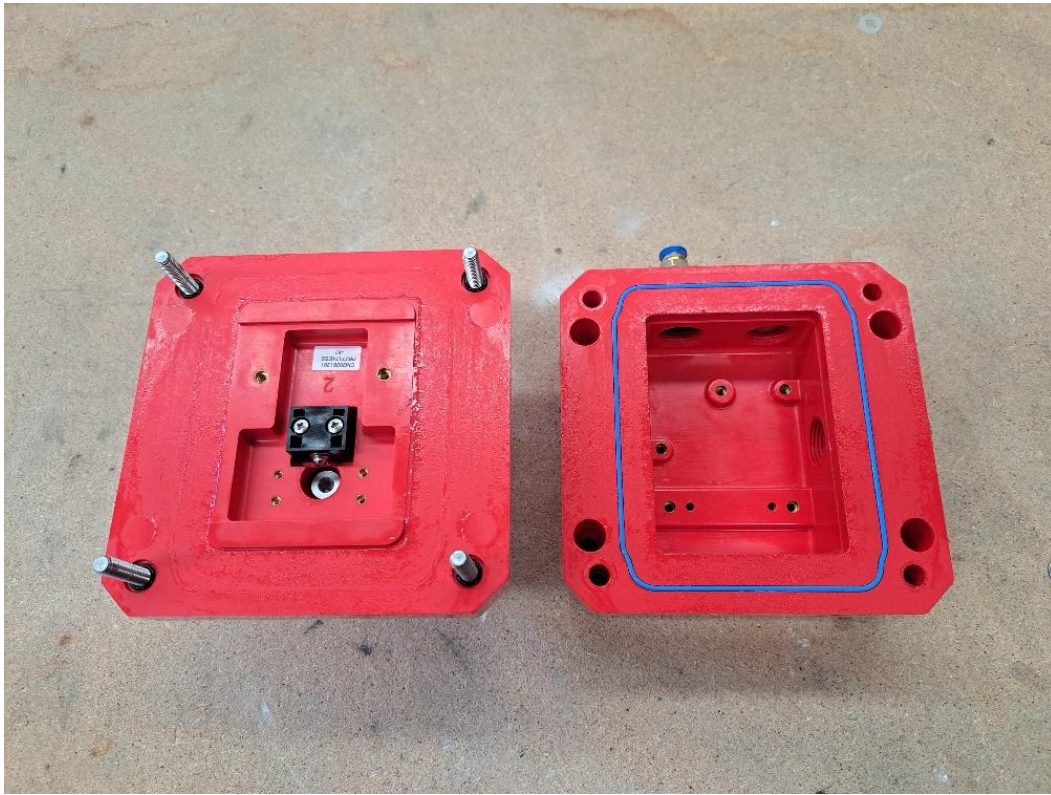

Test Results



Test Setup



Test Equipment

Equipment	Model	Serial
IP4X Access Probe	TRP-02	L06430609
Dust Chamber	-	-
Dust	UKAS calibrated particles	-
Three-phase Compressor	Clarke	3695230050
Manson Power Supply	EP-603	460424750
Digital manometer	RS8890	211016862
Sundely 12V DC Negative Pressure Pump	6W	Z512-604-3000N
Flow meter	Key Instruments (max 0.5l/min)	-

6.5 IPX6

Basic Standard:	EN 60529: 1992 + A2: 2013
Applicability:	Enclosure

Test Results

The enclosure under test was sprayed from all practical directions at a distance of 2500mm to 3000mm with water through a 12.5mm nozzle at a water pressure of 100 litres/min. The equipment under test was sprayed for a period of no less than 3 minutes at each direction.

The enclosure was opened after the test and there was no ingress of water.

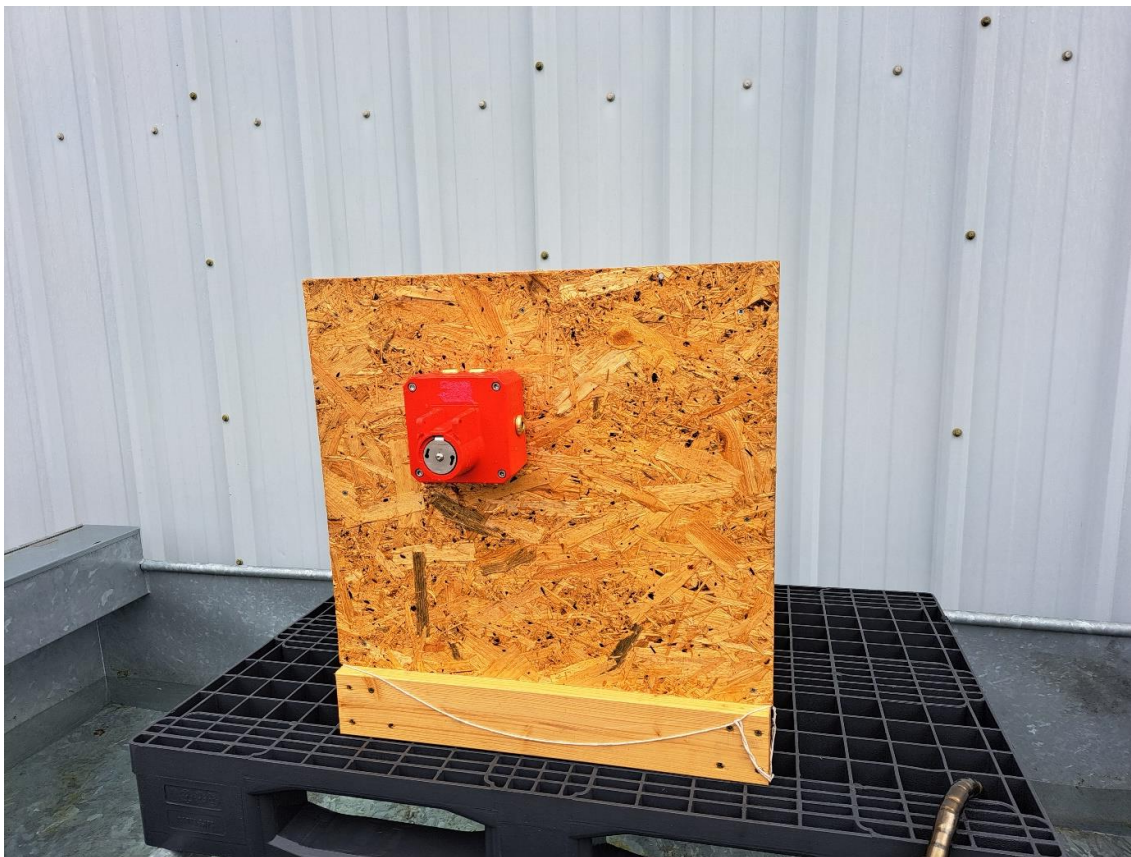

Test Results

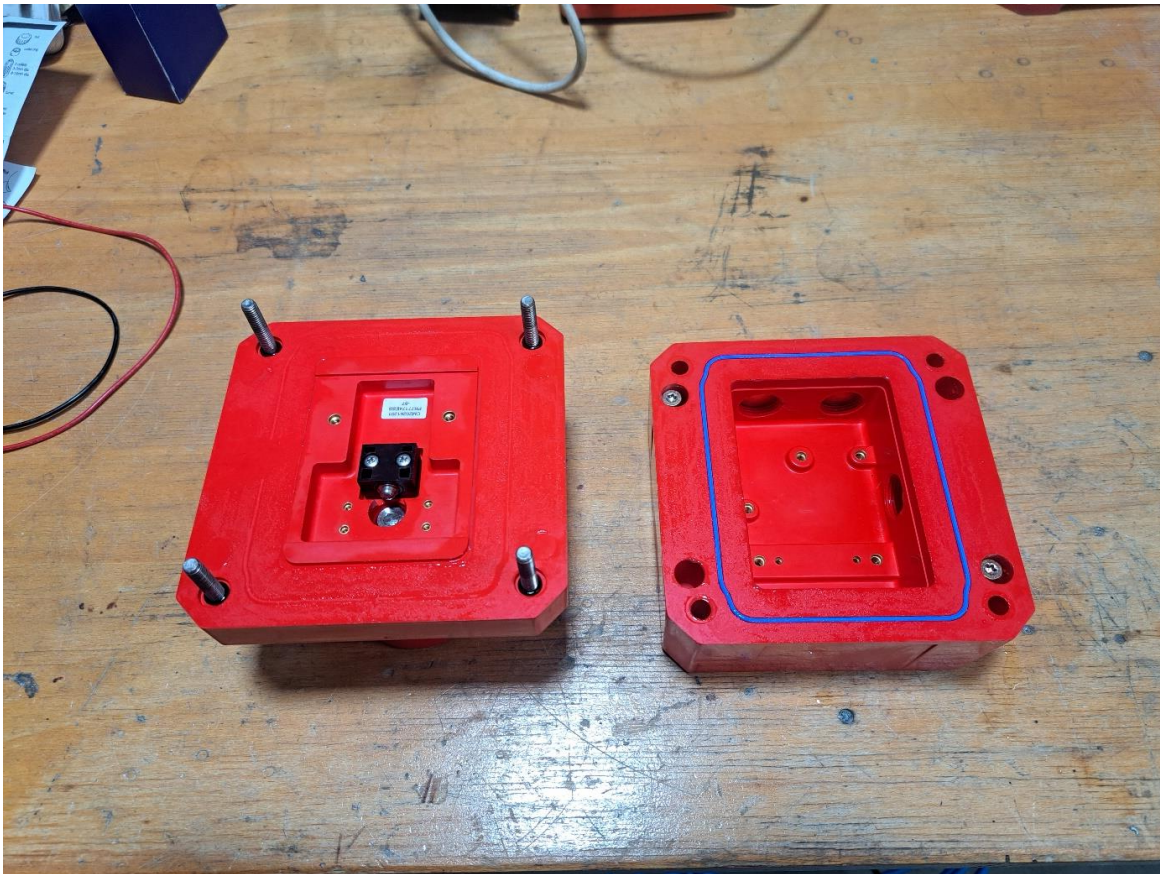

Test Results



Test Results

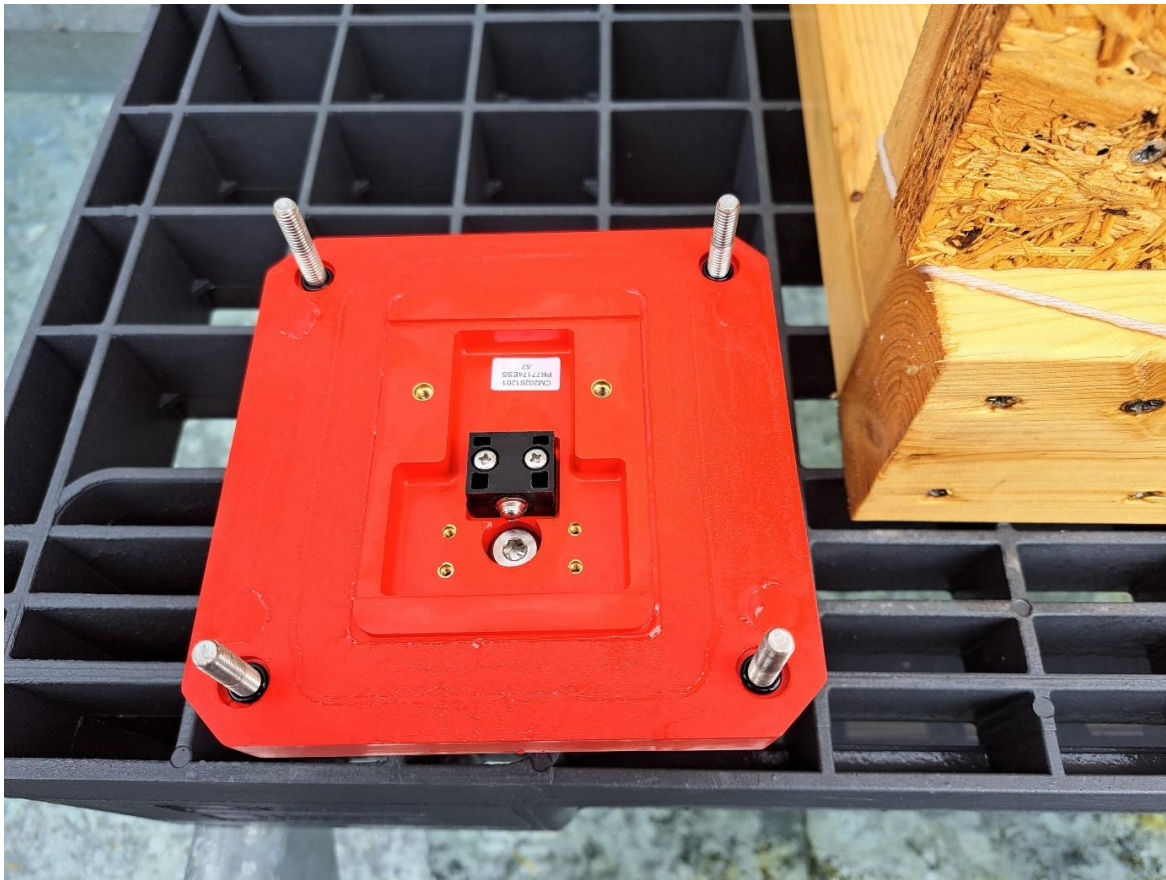

Test Setup

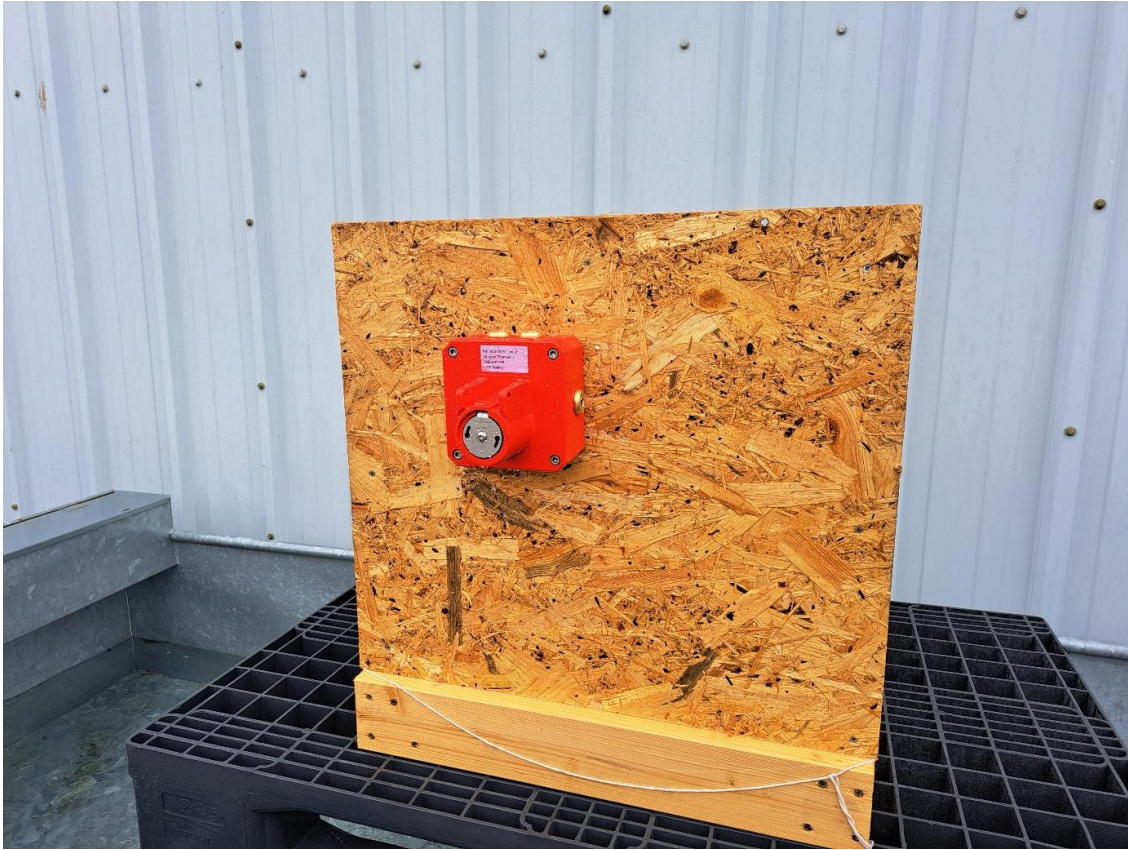

Test Setup



Test Equipment

Equipment	Model	Serial
Water Tank	-	-
Intermediate Bulk Container Tank	-	-
Clarke Water Pump	PW50A	7140640
Tape Measure	RS Pro	-
Thermocouple	Fluke 52	6209074
Test Lance	Jet – 6K	-
12.5mm Jet Nozzle	Jet – 6K	-
Pressure Gauge	SSI	120328012
Pressure Gauge	Wika	11015Y2M

6.6 IPX7

Basic Standard:	EN 60529: 1992 + A2: 2013
Applicable:	Enclosure

Test Result

The enclosure under test was placed in its normal operating orientation into a tank filled with water to a depth of 1 metre for 30 minutes.

The enclosure was opened after the test and there was no ingress of water.



Test Result

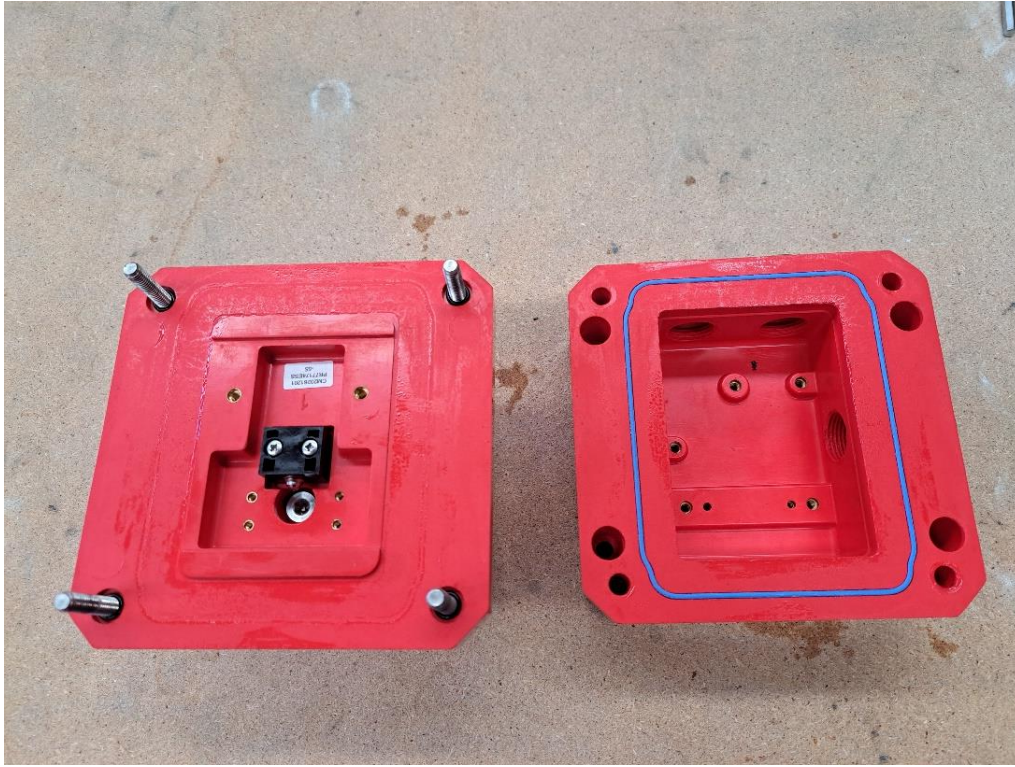

Test Result

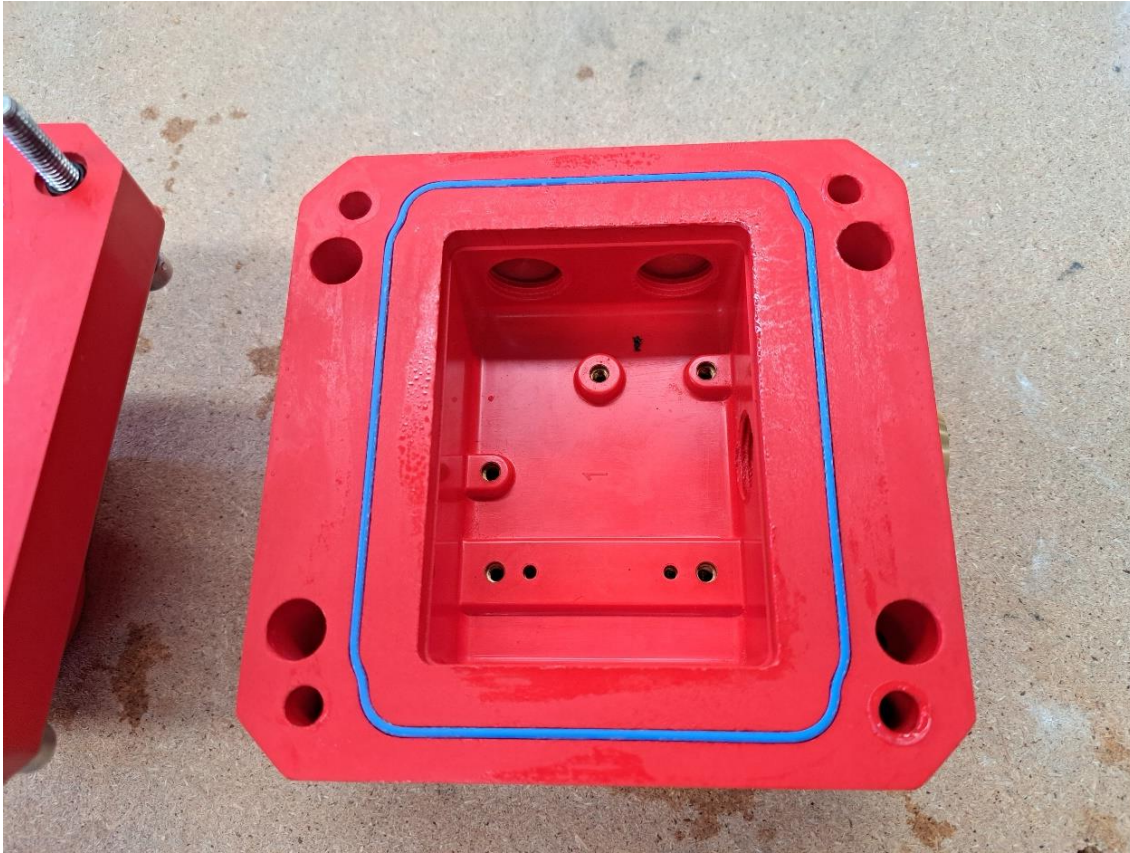

Test Setup

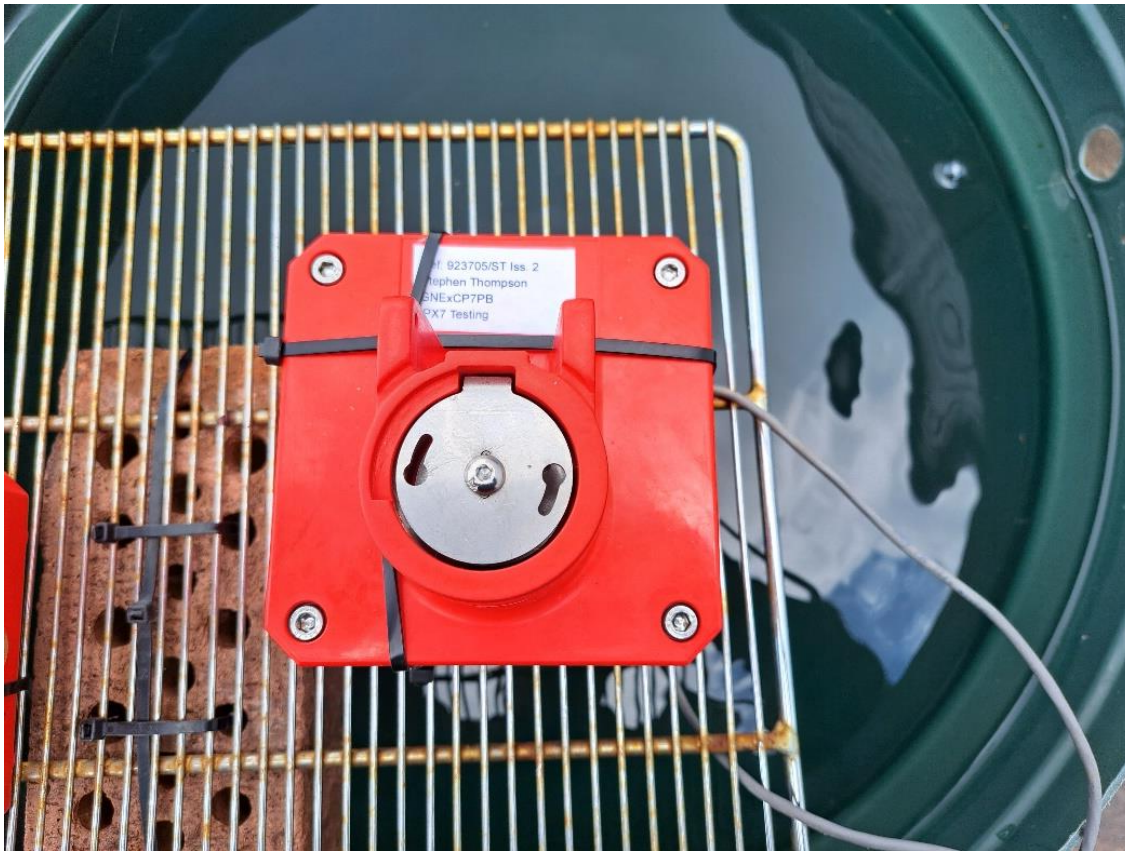

Test Equipment

Equipment	Model	Serial
1000mm Depth Water Tank	-	-
Thermocouple	Fluke 52	6209074
Tape Measure	RS Pro	-

6.7 IPX8

Basic Standard:	EN 60529: 1992 + A2: 2013
Applicable:	Enclosure

Test Result

The enclosure under test is placed into a pressure vessel and submerged in 200mm of water, it is then pressurised to simulate a depth of 35m for 40 hours.

The enclosure was opened after the test and there was no ingress of water.

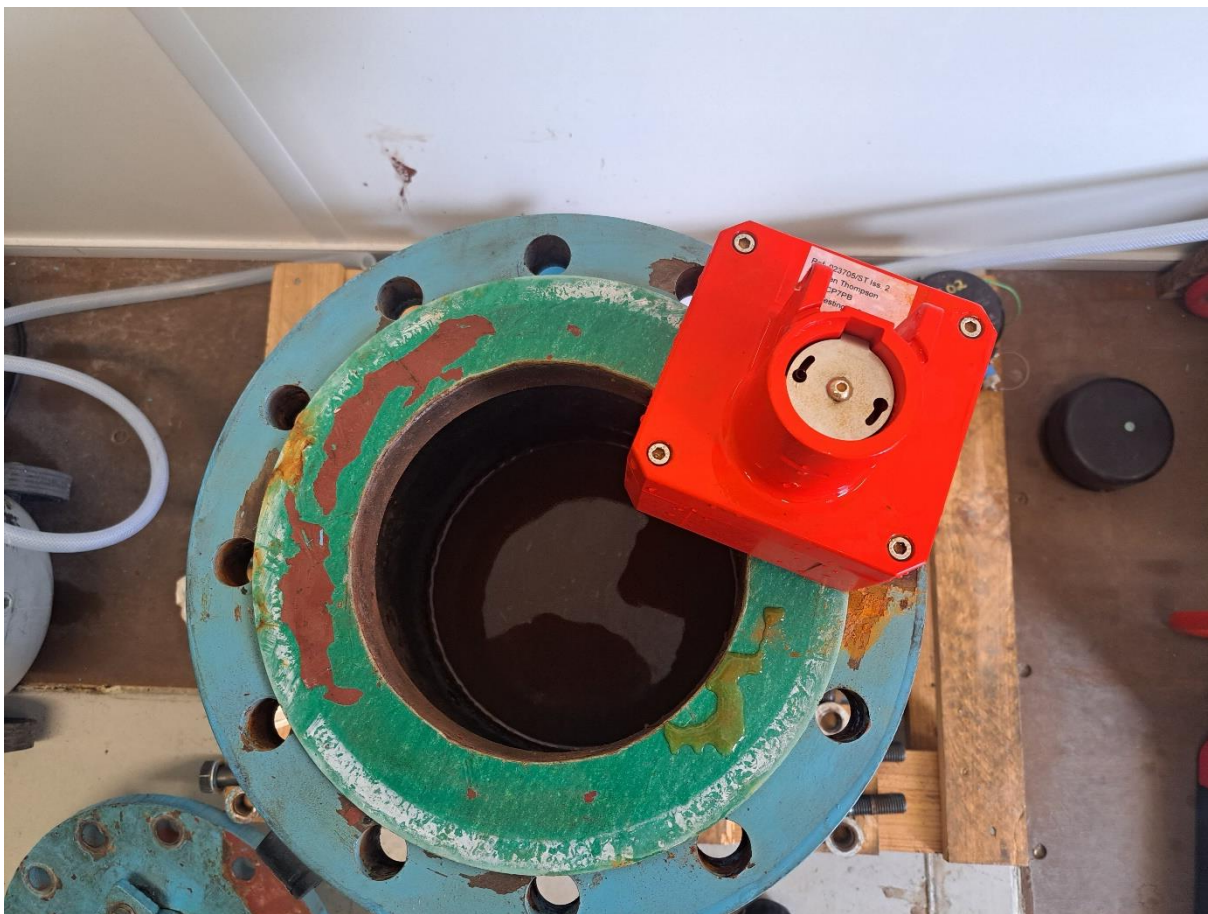

Test Results

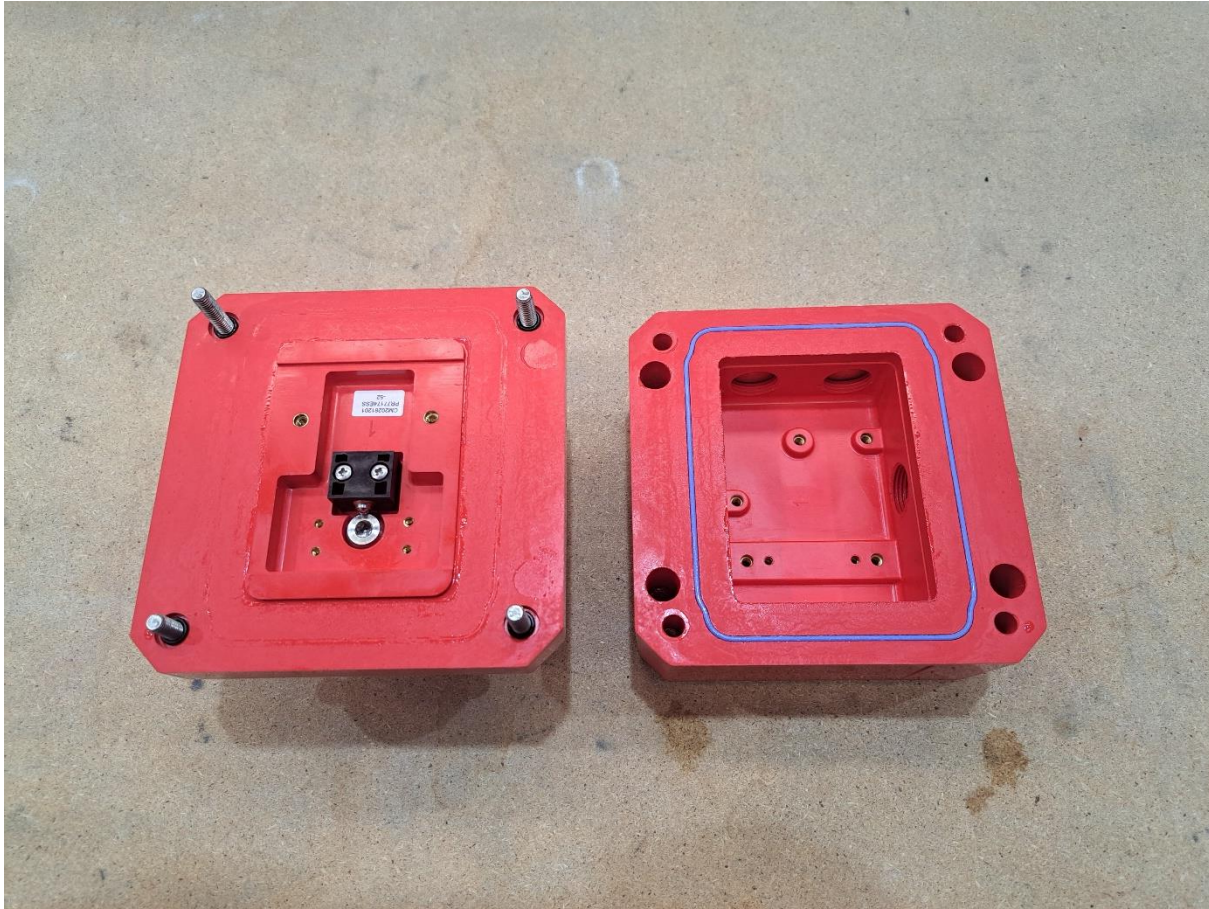

Test Results

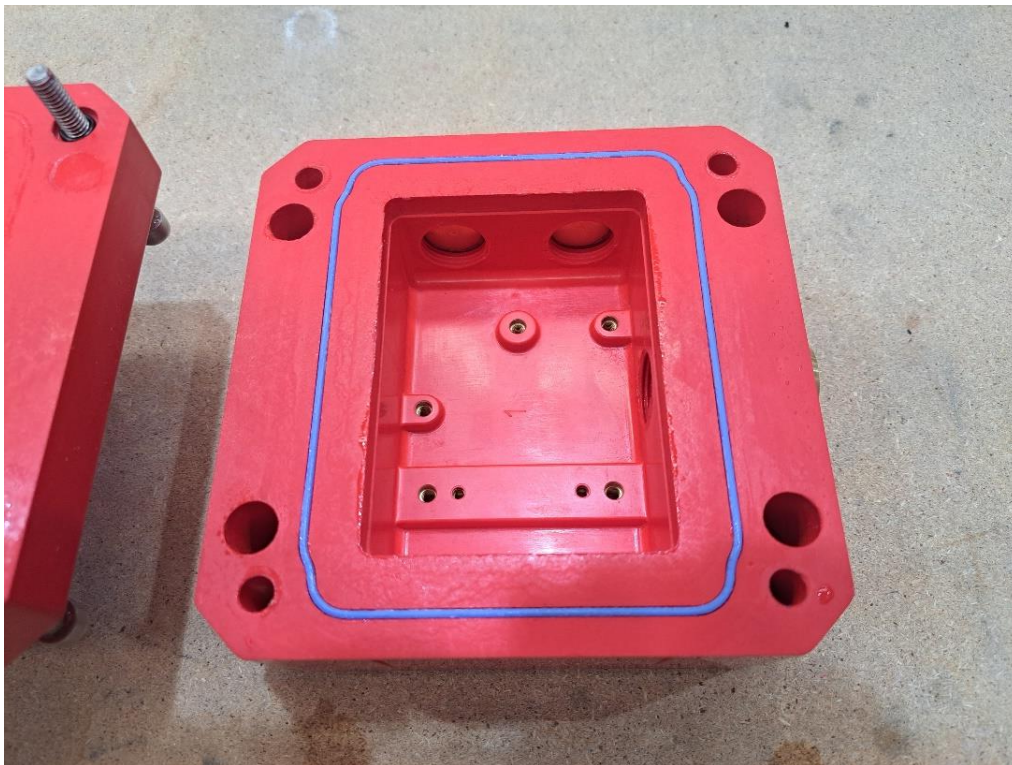
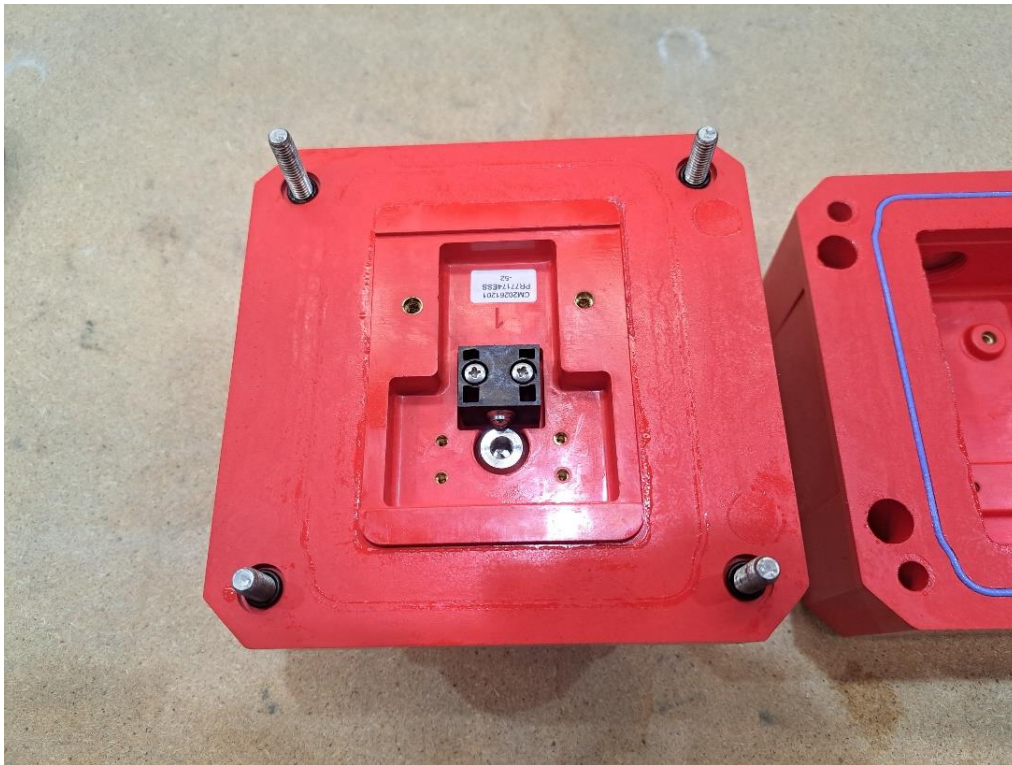

Test Setup

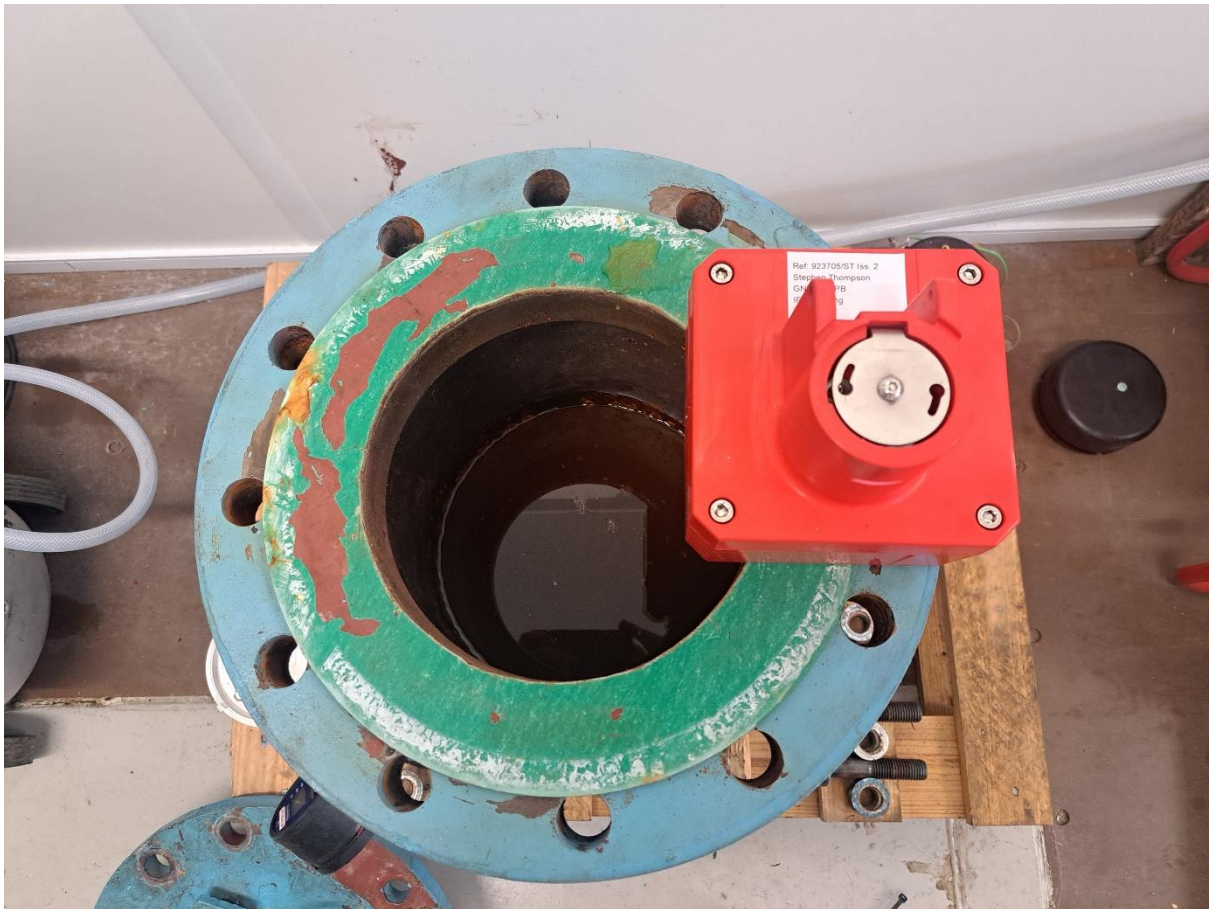

Test Equipment

Equipment	Model	Serial
Pressure Vessel	-	-
Thermocouple	Fluke 52	6209074
Tape Measure	RS Pro	-

END OF REPORT

1	Original Issue	S. Lee	19 th September 2023
ISSUE	MODIFICATION	ISSUED BY	DATE

This test report relates only to the actual item(s) tested, details of which can be found in Section 2 of this report

The test results in this report are facts and any opinions or interpretations derived from the results of these tests shall be marked *

Any testing not presently covered by the scope of our UKAS Schedule of Accreditation shall be marked †

This test report must not be reproduced except in its entirety and with the prior written permission of Mariner Systems (UK) Limited

©2023 Mariner Systems (UK) Limited