

### 1) Warnings



- DO NOT OPEN WHEN AN EXPLOSIVE ATMOSPHERE IS PRESENT
- DO NOT OPEN WHEN ENERGISED
- POTENTIAL ELECTROSTATIC CHARGING HAZARD - CLEAN ONLY WITH A DAMP CLOTH
- HIGH VOLTAGE SHOCK HAZARD. WAIT 5 MINUTES AFTER REMOVING POWER BEFORE OPENING THE ENCLOSURE
- DO NOT PAINT

#### Avertissement:

- NE PAS OUVRIR UN PRESENCE D'ATMOSPHERE EXPLOSIVE
- NE PAS OUVRIR ENERGIE
- DANGER POTENTIEL CHARGE ÉLECTROSTATIQUE - NETTOYER UNIQUEMENT AVEC UN CHIFFON HUMIDE
- HAUT TENSION, RISK DE CHOC. ATTENDEZ 5 MINUTES APRES AVOIR DEBRANCHE L'ALIMENTATION AVANT D'OUVRIR LA BOITIER
- NE PAS PEINTURER

### 2) Rating & Marking Information

#### 2.1 Public Mode Fire Alarm Ratings

The D2xC2XH1 and D2xC2XH2 are certified for use as public mode audible and visual alarm devices in accordance with UL1971 / UL1638 & UL464.

For use in public-mode fire alarm systems the equipment must be installed without the wire guard or plastic lens cover on the beacon.

For light output ratings of the beacon see section 13.

For Fire Alarm applications, the Sounder Volume must be at the highest setting, (see volume control section).

The sounder section produces a sound pressure level above 75dB(A) at 10 feet.

For fire alarm use, the temporal pattern tone No. 12 as per the tone table provided in these instructions must be selected. This tone produces a minimum sound pressure level of:

CAN/ULC-S525: 100.4dB(A)\* at 10 feet.  
(\*anechoic room)  
UL464: 92.2dB(A)† at 10 feet.  
(†reverberation room)

Testing of synchronization requirements of UL1971 & UL1638 / CAN/ULC-S526 were conducted by UL using a total of 6 units connected to the same wire run. Auto-synchronization does not require the use of any external sync modules or protocols. Providing the correct cable has been selected (see section 6) an unlimited number of units will remain synchronized when powered from the same source.

#### 2.2 NEC & CEC Class / Division Ratings for US / Canada

The D2xC2XH1 & D2xC2XH2 Combined unit complies with the following standards:

ANSI/ISA 12.12.01-2015  
CSA C22.2 No. 213-16

The D2xC2XH1 Combined unit is rated as follows:

Class I Div 2 ABCD T3 Ta -40°C to +50°C  
Class II Div 2 FG T6 Ta -40°C to +50°C  
Class III Div 1&2 Ta -40°C to +50°C

The D2xC2XH2 Combined unit is rated as follows:

Class I Div 2 ABCD T2A Ta -40°C to +50°C  
Class II Div 2 FG T6 Ta -40°C to +50°C  
Class III Div 1&2 Ta -40°C to +50°C

Installation must be carried out in compliance with the National Electric Code / Canadian Electric Code

#### 2.3 NEC Class / Zone ratings US

The D2xC2XH1 and D2xC2XH2 Combined unit comply with the following standards:

UL 60079-0-2013  
UL 60079-15-2013  
UL 60079-31-2015

The D2xC2XH1 Combined unit is rated as follows:

Class I Zone 2 AEx nA IIC T3 Gc Ta -40°C to +50°C  
Zone 22 AEx tc IIIC 75°C Dc Ta -40°C to +50°C

The D2xC2XH2 Combined unit is rated as follows:

Class I Zone 2 AEx nA IIC T2 Gc Ta -40°C to +50°C  
Zone 22 AEx tc IIIC 85°C Dc Ta -40°C to +50°C

Installation must be carried out in compliance with the National Electric Code.

## 2.4 CEC Class / Zone ratings Canada

The D2xC2XH1 and D2xC2XH2 Combined unit complies with the following standards:

CAN/CSA C22.2 No. 60079-0:2015  
CAN/CSA C22.2 No. 60079-15:2016  
CAN/CSA C22.2 No. 60079-31:2015

The D2xC2XH1 Combined unit is rated as follows:

Ex nA IIC T3 Gc X Ta -40°C to +50°C  
Ex tc IIIC 75°C Dc Ta -40°C to +50°C

The D2xC2XH2 Combined unit is rated as follows:

Ex nA IIC T2 Gc X Ta -40°C to +50°C  
Ex tc IIIC 85°C Dc Ta -40°C to +50°C

Installation must be carried out in compliance with the Canadian Electric Code

## 2.5 ATEX / IECEx certification

The D2xC2XH1 and D2xC2XH2 Combined unit comply with the following standards:

EN60079-0:2012+A11:2013 / IEC60079-0: ed. 6.0 (2011-06)  
EN60079-15:2010 / IEC60079-15: ed. 4.0 (2010-01)  
EN60079-31:2014 / IEC60079-31:2013 ed. 2.0 (2013-11)

**Certificate No.** DEMKO 14 ATEX 4786493904X  
IECEx ULD 14.0004X

The D2xC2XH1 Combined unit is rated as follows:

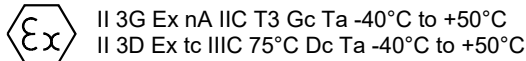

The D2xC2XH2 Combined unit is rated as follows:

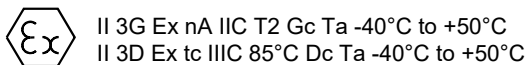

CE Marking



## Zones, Gas / Dust Groups and Temperature Classification

When connected to an approved system the D2xC2XH1 and D2xC2XH2 Combined unit may be installed in:

Zone 2 explosive gas air mixture not likely to occur in normal operation, and if it does, it will only exist for a short time.

Zone 22 explosive dust air mixture not likely to occur in normal operation, and if it does, it will only exist for a short time.

## May be used with gases in groups:

Group IIA propane  
Group IIB ethylene  
Group IIC hydrogen / acetylene

## Having a temperature classification (for Gas applications) of:

T1 450°C  
T2 300°C  
T3 200°C (D2xC2XH1 only)

## May be used with Dust types:

Group IIIA combustible flyings  
Group IIIB non-conductive dust  
Group IIIC conductive dust

## Maximum Surface Temperature for Dust Applications:

D2xC2XH1 75°C & D2xC2XH2 85°C  
Installation must be carried out in compliance with the latest issue of the following standards:  
EN60079-14 / IEC60079-14: Explosive atmospheres - Electrical installations design, selection and erection  
EN60079-10-1 / IEC60079-10-1: Explosive atmospheres - Classification of areas. Explosive gas atmospheres  
EN60079-10-2 / IEC60079-10-2: Explosive atmospheres - Classification of areas. Explosive dust atmospheres

## 2.6 Ingress Protection Ratings

The product is rated for ingress Protection as follows:

IP rating IP66  
Type rating per UL50E / NEMA250: 4 / 4X / 3R / 13

To maintain the ingress protection rating, the cable entries must be fitted with suitably rated, certified cable entry and/or blanking devices during installation.

## 2.7 Electrical Ratings

It is important that a suitable power supply is used to run the equipment. The power supply selected must have the necessary capacity to provide the input current to all the units.

The input current will vary according to the voltage input level.

For detailed current ratings of the device please see Section 14.

## 3) Special Conditions for Safe Use

Special Condition for safe Use as stated on the Type Examination Certificate DEMKO 14 ATEX 4786493904X / CoC IECEx ULD 14.0004X:

When used for a Group III application, the surface of the enclosure may store electrostatic charge and become a source of ignition in applications with a low relative humidity <~30% relative humidity where the surface is relatively free of surface contamination such as dirt, dust, or oil.

Guidance on protection against the risk of ignition due to electrostatic discharge can be found in EN TR50404 and IEC TR60079-32.

End user shall adhere to the manufacturer's installation and instruction when performing housekeeping to avoid the potential for hazardous electrostatic charges during cleaning, by using a damp cloth.

To maintain the ingress protection rating and mode of protection, the cable entries must be fitted with suitably rated, certified cable entry and/or blanking devices during installation. If conduit is used for installation, seal conduit within 18 inches from the enclosure.

Use heat resistant cables and glands (rated 95°C)

#### 4) Location and Mounting

The location of the combined alarm horn and beacon should be made with due regard to the area over which the warning signal must be visible and audible. It should only be fixed to services that can carry the weight of the unit.

D2xC2 Combined unit should be fitted to a flat surface via the two 9.7 x 6.7mm, 147mm pitch fixing holes in the mounting feet of the sounder section and the two 6.9mm, 116mm pitch fixing holes in the feet of the base.

The equipment is not to be mounted with the horn facing upwards.

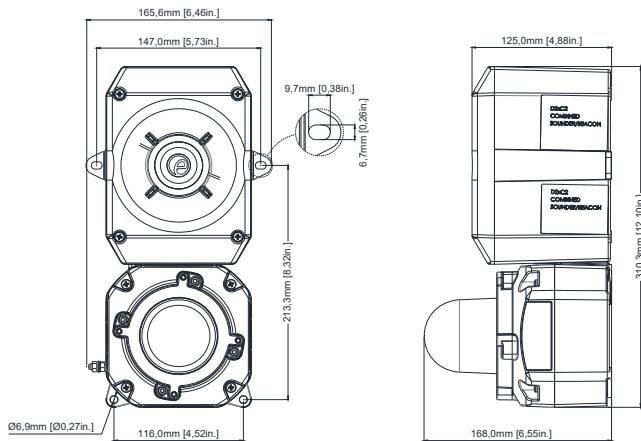

Fig. 1 Fixing locations.

#### 5) Access to the Enclosure



Warning – High voltage may be present, risk of electric shock. DO NOT open when energised, disconnect power before opening.



Warning – Hot surfaces. External surfaces and internal components may be hot after operation, take care when handling the equipment.

To access the enclosure, loosen the four M4 posi pan head screws and withdraw the cover.

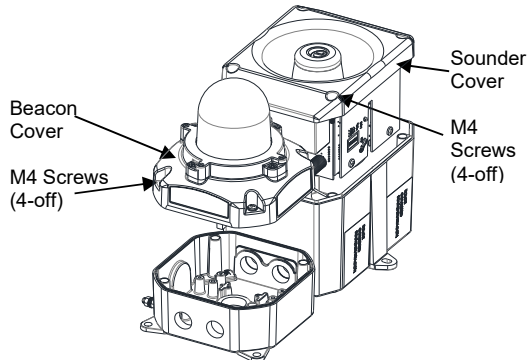

Fig. 2 Accessing Enclosures.

To replace cover, check that the 'O' ring seal is in place. Carefully push the cover in place. Insert M4 screws with fiber washers and tighten to 3Nm torque.

#### 6) Selection of Cable, Cable Glands, Blanking Elements & Adapters

When selecting the cable size, consideration must be given to the input current that each unit draws (see section 14), the number of beacons on the line and the length of the cable runs. The cable size selected must have the necessary capacity to provide the input current to all of the sounders connected to the line.

When selecting the cable size consideration must be given to the voltage drop over the length of the cable run to ensure the min. input voltage at the point of use (voltage range, see section 14)

The voltage drop depends on:

- The total current draw of the devices installed on this cable run
- The wire size and total length of the cable run, determining the total resistance of this cable run
- The minimum output voltage supplied by the power supply

The voltage drop and input voltage at the point of use can be calculated as follows:

$$\text{Total Wire resistance} = \text{Wire resistance} / 1000\text{ft} \times \text{length of cable run} \times 2$$

(length of cable run needs to be multiplied by two to account for two wires going to and from the unit)

$$\text{Total current draw} = \text{Current draw per unit} \times \text{number of units}$$

$$\text{Voltage Drop} = \text{Total current draw} \times \text{Total wire resistance}$$

$$\text{Minimum output of power supply} = \text{Min. voltage at point of use} + \text{voltage drop}$$

For ambient temperatures over +45°C the cable entry temperature may exceed +70°C. Therefore suitable heat resisting cables and cable glands rated to min. 95°C must be used:

If a high IP (Ingress Protection) rating is required then a suitable sealing washer must be fitted under the cable glands or blanking plugs.

For use in explosive dust atmospheres, a minimum ingress protection rating of IP6X must be maintained.

For use in explosive gas atmospheres, a minimum ingress protection rating of IP54 must be maintained.

NPT plugs should be greased before insertion.

## 7) Cable Connections

Electrical connections are to be made into the terminal blocks on the PCBA located in the enclosure. See section 5 of this manual for access to the enclosure.

Wires having a cross sectional area between 0.5 mm<sup>2</sup> to 2.5mm<sup>2</sup> can be connected to each terminal way. If an input and output wire is required the 2-off Live/Neutral or +/- terminals can be used. If fitting 2-off wires to one terminal way the sum of the 2-off wires must be a maximum cross sectional area of 2.5mm<sup>2</sup>. Strip wires to 8mm. Wires may also be fitted using ferrules. Terminal screws need to be tightened down with a tightening torque of 0.56 Nm / 5 Lb-in. When connecting wires to the terminals great care should be taken to dress the wires so that when the cover is inserted into the chamber the wires do not exert excess pressure on the terminal blocks. This is particularly important when using cables with large cross sectional areas such as 2.5mm<sup>2</sup>.

## 8) Wiring

### 8.1 Wiring Diagrams

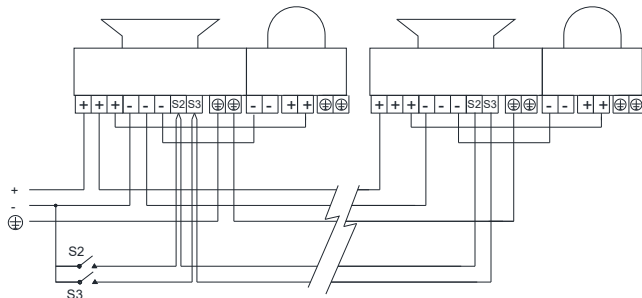

STAGE 4 = S2 + S3  
(Customer Supplied)

Fig. 3 Simplified Block Diagram

### 8.2 Units First Stage Tones

Stage one (S1) operation: Simply connect the supply voltage to the + and - supply terminals, (see fig. 3). The Strobe is powered via factory installed wires connected to the alarm horn. The wires connecting the alarm horn and strobe can be removed if the user wishes to power the strobe separately.

### 8.3 Second, Third and Fourth Stage Tone Selection

Stage two (S2) operation: Power +ve and -ve, link a -ve supply line to the S2 terminal.

Stage three (S3) operation: Power +ve and -ve, link a -ve supply line to the S3 terminal.

Stage four (S4) operation: Power +ve and -ve, link a -ve supply line to both the S2 & S3 terminals.

Strobe will continue to flash during alarm horn S2, S3 & S4 stages.

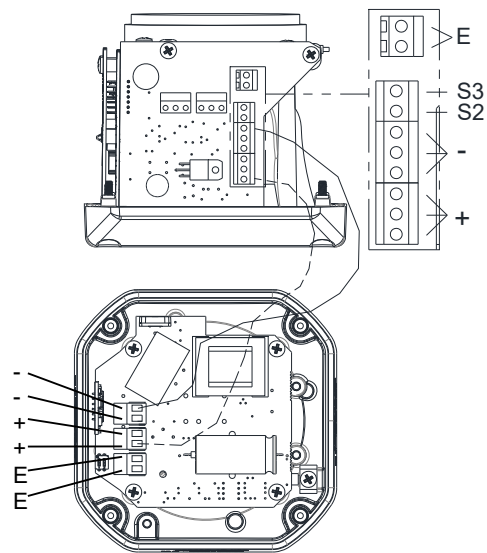

Fig. 4 Terminals

## 9) Earthing

The unit has both internal and external earth points, (please see fig 2 & fig 4).

Internal earthing connections should be made to the internal earth terminal on the PCBA, (please see fig 4). The earth conductor should be at least equal in size and rating to the incoming power conductors. The internal earth bonding wire connects the PCBA earth terminal to the internal earth terminal in the enclosure back box.

External earth connections should be made to the M5 earth stud on the beacon housing, using a ring crimp terminal to secure the earth conductor to the earth stud. The external earth conductor should be at least 4mm<sup>2</sup> in size. The external earth crimp ring should be located between the two M5 plain washers provided and securely locked down with the M5 spring washer and M5 nut.

## 10) End Of Line Monitoring

On Dx2XH1 & D2xC2XH2 units, dc reverse line monitoring can be used if required. All units have a blocking diode fitted in their supply input lines. An end of line monitoring resistor can be connected across the +ve and -ve terminals. If an end of line resistor is used it must have the following values:-

|                             |                      |
|-----------------------------|----------------------|
| Minimum Resistance 3k9 ohms | Minimum wattage 0.5W |
| Minimum Resistance 1k ohms  | Minimum wattage 2.0W |

The resistor must be connected directly across the +ve and -ve terminals of the sounder board only, as shown in the following drawing. Whilst keeping its leads as short as possible, a spacing of at least 1/16 inch (1.58mm) must be provided through air and over surfaces between uninsulated live parts.

The resistor must be connected directly across the +ve and -ve terminals as shown in the following drawing. Form the resistor legs as shown in Fig. 5, remove the +ve and -ve terminal plugs and fit the resistor across the two terminal plugs before refitting them to the PCBA as shown in Fig. 6a & 6b. A spacing of at least 1/16" (1.58mm) must be provided through air and over surfaces between uninsulated live parts.

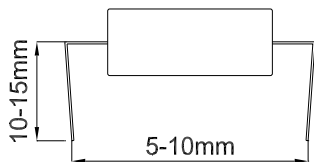

Fig. 5 End of Line Resistor Forming

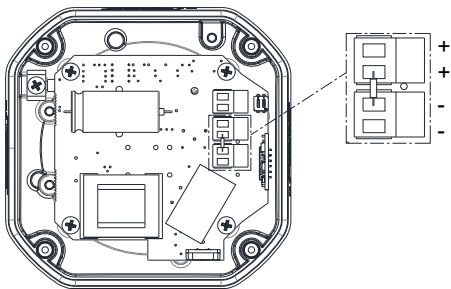

Fig. 6a End of Line Resistor Placement - Beacon

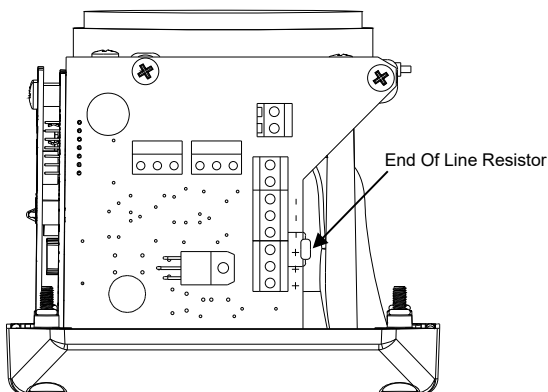

Fig. 6b End of Line Resistor Placement – Sounder

## 11) Settings

### 11.1 Beacon DIP Switch

Please note that the D2xC2XH1 & D2xC2XH2 beacon PCBAs have a DIP Switch that is NOT customer configurable. This should only ever be set to '00'.

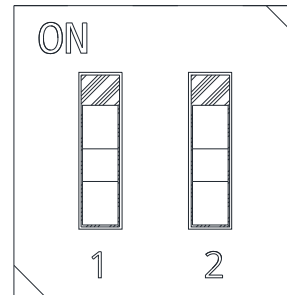

Fig. 6 DIP Switch setting '00'

### 11.2 Volume Control

The alarm horn output level of the D2xC2 unit can be set by adjusting the volume control potentiometer (see Fig 9). For maximum output, set the potentiometer fully clockwise.

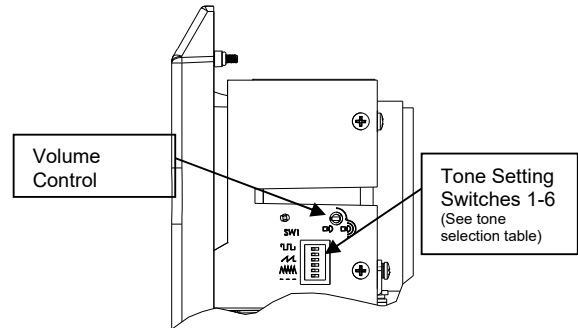

Fig. 9 Location of field controls

### 11.3 Tone Selection

The D2xC2 alarm horns have 64 different tones. The tones are selected by operation of the tone setting DIP switches (see Fig. 9) on the PCB. The alarm horns can also be switched to sound the second, third and fourth stage alarm tones. The tone table shows the switch positions for the 64 tone and which tones are available for the second, third and fourth stages.

## 12) Maintenance, Overhaul & Repair

Maintenance, repair and overhaul of the equipment should only be carried out by suitably qualified personnel in accordance with the current relevant standards:

|             |   |
|-------------|---|
| EN60079-19  | Explosive atmospheres - Equipment repair, overhaul and reclamation          |
| IEC60079-19 |   |
| EN 60079-17 | Explosive atmospheres - Electrical installations inspection and maintenance |
| IEC60079-17 |   |

To avoid a possible ELECTROSTATIC CHARGE the unit must only be cleaned with a damp cloth.

Units must not be opened while an explosive atmosphere is present.

If opening the unit during maintenance operations a clean environment must be maintained and any dust layer removed prior to opening the unit.

### 13) Light output for Fire alarm use

In order to meet the requirements for UL 1971, (when used with 1Hz Flash rate), the installation must be carried out to the correct NFPA standards and guidelines.

#### 13.1 Horizontal Light Output Dispersion for wall mounting – public mode

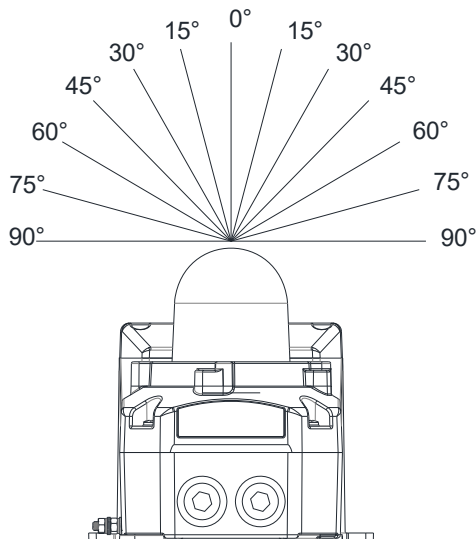

Fig. 12 – Horizontal dispersion angles for wall mounting

| Table 3A - D2xC2XH1 - Horizontal Light Output Dispersion for Wall Mounting |             |                                  |
|--|-------------|----------------------------------|
| Viewing Angle  | % Of Rating | Intensity (cd) at 1Hz flash rate |
| 0°   | 100         | 18.18                            |
| 5-25°  | 90          | 16.36                            |
| 30-45°   | 75          | 13.64                            |
| 50°  | 55          | 10.00                            |
| 55°  | 45          | 8.18                             |
| 60°  | 40          | 7.27                             |
| 65°  | 35          | 6.36                             |
| 70°  | 35          | 6.36                             |
| 75°  | 30          | 5.45                             |
| 80°  | 30          | 5.45                             |
| 85°  | 25          | 4.55                             |
| 90°  | 25          | 4.55                             |
| Compound 45°   | 24          | 4.36                             |

| Table 3A - D2xC2XH2 - Horizontal Light Output Dispersion for Wall Mounting |             |                                  |
|--|-------------|----------------------------------|
| Viewing Angle  | % Of Rating | Intensity (cd) at 1Hz flash rate |
| 0°   | 100         | 63.73                            |
| 5-25°  | 90          | 57.36                            |
| 30-45°   | 75          | 47.80                            |
| 50°  | 55          | 35.05                            |
| 55°  | 45          | 28.68                            |
| 60°  | 40          | 25.49                            |
| 65°  | 35          | 22.31                            |
| 70°  | 35          | 22.31                            |
| 75°  | 30          | 19.12                            |
| 80°  | 30          | 19.12                            |
| 85°  | 25          | 15.93                            |
| 90°  | 25          | 15.93                            |
| Compound 45°   | 24          | 15.30                            |

### 13.2 Vertical Light Output Dispersion for wall mounting – public mode

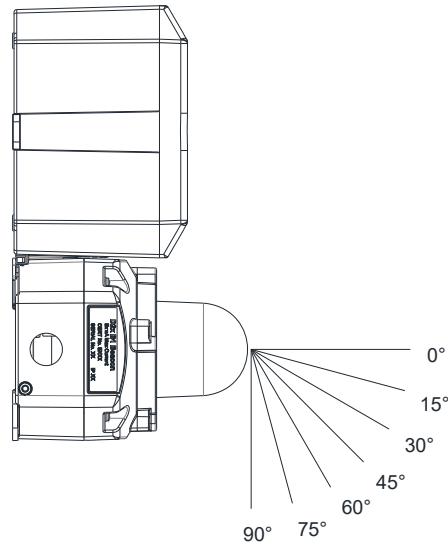

Fig. 13 – Vertical dispersion angles for wall mounting

| Table 4A – D2xC2XH1 - Vertical Light Output Dispersion for Wall Mounting |             |                                  |
|--|-------------|----------------------------------|
| Viewing Angle  | % Of Rating | Intensity (cd) at 1Hz flash rate |
| 0°   | 100         | 18.18                            |
| 5-30°  | 90          | 16.36                            |
| 35°  | 65          | 11.82                            |
| 40°  | 46          | 8.36                             |
| 45°  | 34          | 6.18                             |
| 50°  | 27          | 4.91                             |
| 55°  | 22          | 4.00                             |
| 60°  | 18          | 3.27                             |
| 65°  | 16          | 2.91                             |
| 70°  | 15          | 2.73                             |
| 75°  | 13          | 2.36                             |
| 80-90°   | 12          | 2.18                             |

| Table 4B– D2xC2XH2 - Vertical Light Output Dispersion for Wall Mounting |             |                                  |
|---|-------------|----------------------------------|
| Viewing Angle   | % Of Rating | Intensity (cd) at 1Hz flash rate |
| 0°  | 100         | 63.73                            |
| 5-30°   | 90          | 57.36                            |
| 35°   | 65          | 41.42                            |
| 40°   | 46          | 29.32                            |
| 45°   | 34          | 21.67                            |
| 50°   | 27          | 17.21                            |
| 55°   | 22          | 14.02                            |
| 60°   | 18          | 11.47                            |
| 65°   | 16          | 10.20                            |
| 70°   | 15          | 9.56                             |
| 75°   | 13          | 8.28                             |
| 80-90°  | 12          | 7.65                             |

### 13.3 Vertical Light Output Dispersion for ceiling mounting – public mode

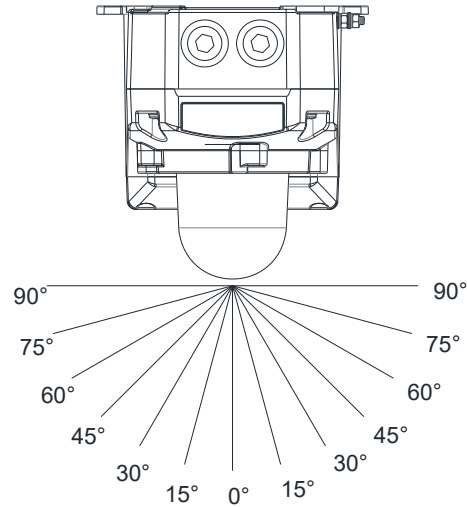

Fig. 14 – Vertical dispersion angles for ceiling mounting X and Y planes

| <b>Table 5A– D2xC2XH1 – Vertical Light Output Dispersion for Ceiling Mounting</b> |                    |   |
|---|--------------------|---|
| <b>Viewing Angle</b>  | <b>% Of Rating</b> | <b>Intensity (cd) at 1Hz flash rate</b> |
| 0°  | 100                | 18.18                                   |
| 5-25°   | 90                 | 16.36                                   |
| 30-45°  | 75                 | 13.64                                   |
| 50°   | 55                 | 10.00                                   |
| 55°   | 45                 | 8.18                                    |
| 60°   | 40                 | 7.27                                    |
| 65°   | 35                 | 6.36                                    |
| 70°   | 35                 | 6.36                                    |
| 75°   | 30                 | 5.45                                    |
| 80°   | 30                 | 5.45                                    |
| 85°   | 25                 | 4.55                                    |
| 90°   | 25                 | 4.55                                    |

| <b>Table 5B– D2xC2XH2 – Vertical Light Output Dispersion for Ceiling Mounting</b> |                    |   |
|---|--------------------|---|
| <b>Viewing Angle</b>  | <b>% Of Rating</b> | <b>Intensity (cd) at 1Hz flash rate</b> |
| 0°  | 100                | 63.73                                   |
| 5-25°   | 90                 | 57.357                                  |
| 30-45°  | 75                 | 47.7975                                 |
| 50°   | 55                 | 35.0515                                 |
| 55°   | 45                 | 28.6785                                 |
| 60°   | 40                 | 25.492                                  |
| 65°   | 35                 | 22.3055                                 |
| 70°   | 35                 | 22.3055                                 |
| 75°   | 30                 | 19.119                                  |
| 80°   | 30                 | 19.119                                  |
| 85°   | 25                 | 15.9325                                 |
| 90°   | 25                 | 15.9325                                 |



All light output ratings min. values as per UL 1971 / UL1638 / CAN/ULC-S526 at worst-case (min.) input voltage.

## 14) Electrical Ratings

### 14.1 Operating current Consumption

| Table 6 – Electrical Ratings |              |               |                    |                                      |
|------------------------------|--------------|---------------|--------------------|--------------------------------------|
| Model                        | Nom. Voltage | Voltage Range | Flash Rate Setting | Max. operating current <sup>##</sup> |
| D2xC2XH1DC024                | 24Vdc        | 20-28Vdc      | 1Hz (60fpm)        | 0.449A                               |
| D2xC2XH2DC024                | 24Vdc        | 20-28Vdc      | 1Hz (60fpm)        | 0.785A                               |

For Public Mode Fire Alarm use

## max. rms current at worst-case voltage in voltage range.

### 14.2 Surge current for Fire Alarm system use

| Table 7 – Surge Currents |              |               |                    |                    |                   |
|--------------------------|--------------|---------------|--------------------|--------------------|-------------------|
| Model                    | Nom. Voltage | Voltage Range | Flash Rate Setting | Peak Surge current | RMS surge current |
| D2xC2XH1DC024            | 24Vdc        | 20-28Vdc      | 1Hz (60fpm)        | 2.28A              | 1.19A             |
| D2xC2XH2DC024            | 24Vdc        | 20-28Vdc      | 1Hz (60fpm)        | 2.76A              | 1.35A             |

## 15) Sound Directional Characteristics for Canadian Fire CAN/ULC-S525

### Horizontal Axis

| Angle           | OSPL        | Angle           | OSPL        |
|-----------------|-------------|-----------------|-------------|
| Reference (90°) | 101.2 dB(A) | Reference (90°) | 101.2 dB(A) |
| 115°            | -3 dB(A)    | 68°             | -3 dB(A)    |
| 129°            | -6 dB(A)    | 55°             | -6 dB(A)    |
| 180°            | 92.4 dB(A)  | 0°              | 92.4        |

### Vertical Axis

| Angle           | OSPL        | Angle           | OSPL        |
|-----------------|-------------|-----------------|-------------|
| Reference (90°) | 101.5 dB(A) | Reference (90°) | 101.5 dB(A) |
| 123°            | -3 dB(A)    | 65°             | -3 dB(A)    |
| 137°            | -6 dB(A)    | 50°             | -6 dB(A)    |
| 180°            | 91 dB(A)    | 0°              | 88.5 dB(A)  |

## 16) Tone Table

**Tone Selection** – To select the required first stage tone set the tone switches 1 to 6 (see Fig 9) to the tone setting shown in the table below. The table also shows which 2<sup>nd</sup>, 3<sup>rd</sup> and 4<sup>th</sup> stage tones are available for use with the selected first stage tone if more than one tone output stage is required.

| Stage 1<br>Tone No | Tone Description   | Tone Visual | Switch Settings<br>1 2 3 4 5 6 | Stage 2<br>Tone<br>(S2) | Stage 3<br>Tone<br>(S3) | Stage 4<br>Tone<br>(S2 + S3) |
|--------------------|--|-------------|--------------------------------|-------------------------|-------------------------|------------------------------|
| 1                  | 1000Hz PFEER Toxic Gas   | 1000Hz      | 0 0 0 0 0 0                    | 3                       | 2                       | 44                           |
| 2                  | 1200/500Hz @ 1Hz DIN / PFEER P.T.A.P.                              | 1200Hz      | 1 0 0 0 0 0                    | 1                       | 3                       | 44                           |
| 3                  | 1000Hz @ 0.5Hz(1s on, 1s off) PFEER Gen. Alarm                     | 1000Hz      | 0 1 0 0 0 0                    | 1                       | 2                       | 44                           |
| 4                  | 1.4KHz-1.6KHz 1s, 1.6KHz-1.4KHz 0.5s NF C 48-265                   | 1600Hz      | 1 1 0 0 0 0                    | 44                      | 24                      | 1                            |
| 5                  | 544Hz(100mS)/440Hz (400mS) NF S 32-001                             | 544Hz       | 0 0 1 0 0 0                    | 52                      | 19                      | 1                            |
| 6                  | 1500/500Hz - (0.5s on, 0.5s off) x3 + 1s gap AS4428                | 1500Hz      | 1 0 1 0 0 0                    | 7                       | 44                      | 1                            |
| 7                  | 500-1500Hz Sweeping 2 sec on 1 sec off AS4428                      | 1500Hz      | 0 1 1 0 0 0                    | 6                       | 44                      | 1                            |
| 8                  | 500/1200Hz @ 0.26Hz(3.3s on, 0.5s off) Netherlands - NEN 2575      | 1200Hz      | 1 1 1 0 0 0                    | 44                      | 24                      | 35                           |
| 9                  | 1000Hz (1s on, 1s off)x7 + (7s on, 1s off) IMO Code 1a             | 1000Hz      | 0 0 0 1 0 0                    | 18                      | 34                      | 1                            |
| 10                 | 1000Hz (1s on, 1s off)x7 + (7s on, 1s off) IMO Code 1a             | 1000Hz      | 1 0 0 1 0 0                    | 21                      | 34                      | 1                            |
| 11                 | 420Hz(0.5s on, 0.5s off)x3 + 1s gap ISO 8201 Temporal Pattern      | 420Hz       | 0 1 0 1 0 0                    | 44                      | 1                       | 8                            |
| 12                 | 1000Hz(0.5s on, 0.5s off)x3 + 1s gap ISO 8201 Temporal Pattern     | 1000Hz      | 1 1 0 1 0 0                    | 44                      | 1                       | 8                            |
| 13                 | 422/775Hz - (0.85s on, 0.5s off) x3 + 1s gap NFPA - Temporal Coded | 775Hz       | 0 0 1 1 0 0                    | 44                      | 1                       | 8                            |
| 14                 | 1000/2000Hz @ 1Hz Singapore  | 2000Hz      | 1 0 1 1 0 0                    | 23                      | 3                       | 35                           |
| 15                 | 300Hz Continuous   | 300Hz       | 0 1 1 1 0 0                    | 44                      | 24                      | 35                           |
| 16                 | 440Hz Continuous   | 440Hz       | 1 1 1 1 0 0                    | 44                      | 24                      | 35                           |
| 17                 | 470Hz Continuous   | 470Hz       | 0 0 0 0 1 0                    | 44                      | 24                      | 35                           |
| 18                 | 500Hz Continuous IMO code 2 (Low)                                  | 500Hz       | 1 0 0 0 1 0                    | 44                      | 24                      | 35                           |
| 19                 | 554Hz Continuous   | 554Hz       | 0 1 0 0 1 0                    | 64                      | 24                      | 35                           |
| 20                 | 660Hz Continuous   | 660Hz       | 1 1 0 0 1 0                    | 44                      | 24                      | 35                           |
| 21                 | 800Hz IMO code 2 (High)  | 800Hz       | 0 0 1 0 1 0                    | 44                      | 24                      | 35                           |
| 22                 | 1200Hz Continuous  | 1200Hz      | 1 0 1 0 1 0                    | 44                      | 24                      | 35                           |
| 23                 | 2000Hz Continuous  | 2000Hz      | 0 1 1 0 1 0                    | 15                      | 3                       | 35                           |
| 24                 | 2400Hz Continuous  | 2400Hz      | 1 1 1 0 1 0                    | 48                      | 20                      | 35                           |
| 25                 | 440 @0.83Hz (50 cycles/minute) Intermittent                        | 440Hz       | 0 0 0 1 1 0                    | 1                       | 44                      | 8                            |
| 26                 | 470 @0.9Hz - 1.1s Intermittent                                     | 470Hz       | 1 0 0 1 1 0                    | 1                       | 44                      | 8                            |
| 27                 | 470Hz @5Hz - (5 cycles/second) Intermittent                        | 470Hz       | 0 1 0 1 1 0                    | 1                       | 44                      | 8                            |
| 28                 | 544Hz @ 1.14Hz - 0.875s Intermittent                               | 470Hz       | 1 1 0 1 1 0                    | 44                      | 24                      | 8                            |
| 29                 | 655Hz @ 0.875Hz Intermittent                                       | 655Hz       | 0 0 1 1 1 0                    | 1                       | 44                      | 8                            |
| 30                 | 660Hz @0.28Hz - 1.8sec on, 1.8sec off Intermittent                 | 660Hz       | 1 0 1 1 1 0                    | 44                      | 24                      | 8                            |
| 31                 | 660Hz @3.34Hz - 150mS on, 150mS off Intermittent                   | 660Hz       | 0 1 1 1 1 0                    | 30                      | 24                      | 8                            |

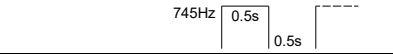
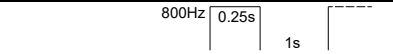
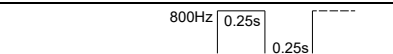
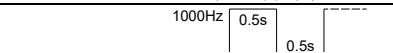
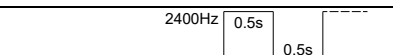
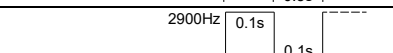
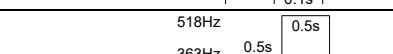
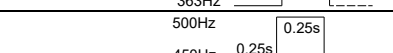
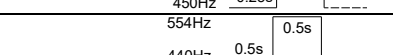
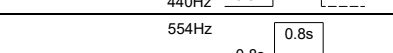
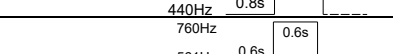
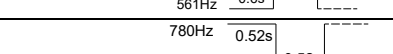
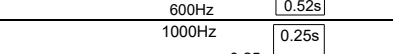
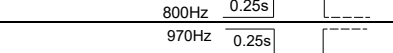
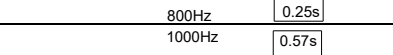
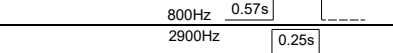
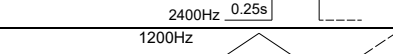
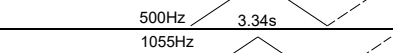
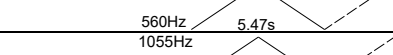
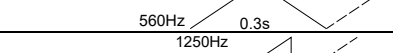
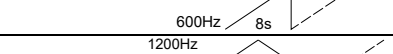
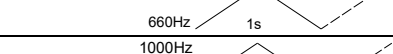
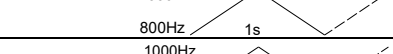
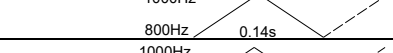
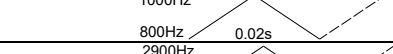
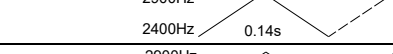
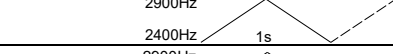
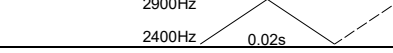
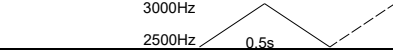
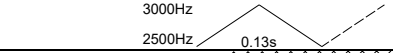
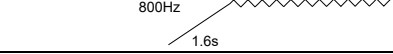
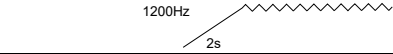
|    |   |   |             |    |    |    |
|----|---|---|-------------|----|----|----|
| 32 | 745Hz @ 1Hz Intermittent                          |    | 1 1 1 1 1 0 | 44 | 24 | 8  |
| 33 | 800Hz - 0.25sec on, 1 sec off Intermittent        |    | 0 0 0 0 0 1 | 53 | 24 | 8  |
| 34 | 800Hz @ 2Hz IMO code 3.a (High) Intermittent      |    | 1 0 0 0 0 1 | 56 | 24 | 8  |
| 35 | 1000Hz @ 1Hz Intermittent                         |    | 0 1 0 0 0 1 | 44 | 24 | 8  |
| 36 | 2400Hz @ 1Hz Intermittent                         |    | 1 1 0 0 0 1 | 21 | 24 | 8  |
| 37 | 2900Hz @ 5Hz Intermittent                         |    | 0 0 1 0 0 1 | 53 | 24 | 8  |
| 38 | 363/518Hz @ 1Hz Alternating                       |    | 1 0 1 0 0 1 | 1  | 8  | 19 |
| 39 | 450/500Hz @ 2Hz Alternating                       |    | 0 1 1 0 0 1 | 1  | 8  | 19 |
| 40 | 554/440Hz @ 1Hz Alternating                       |    | 1 1 1 0 0 1 | 44 | 24 | 19 |
| 41 | 554/440Hz @ 0.625Hz Alternating                   |    | 0 0 0 1 0 1 | 1  | 8  | 19 |
| 42 | 561/760Hz @ 0.83Hz (50 cycles/minute) Alternating |    | 1 0 0 1 0 1 | 1  | 8  | 19 |
| 43 | 780/600Hz @ 0.96Hz Alternating                    |    | 0 1 0 1 0 1 | 1  | 8  | 19 |
| 44 | 800/1000Hz @ 2Hz Alternating                      |    | 1 1 0 1 0 1 | 5  | 24 | 19 |
| 45 | 970/800Hz @ 2Hz Alternating                       |    | 0 0 1 1 0 1 | 1  | 8  | 19 |
| 46 | 800/1000Hz @ 0.875Hz Alternating                  |    | 1 0 1 1 0 1 | 53 | 24 | 19 |
| 47 | 2400/2900Hz @ 2Hz Alternating                     |    | 0 1 1 1 0 1 | 57 | 24 | 19 |
| 48 | 500/1200Hz @ 0.3Hz Sweeping                       |   | 1 1 1 1 0 1 | 44 | 24 | 12 |
| 49 | 560/1055Hz @ 0.18Hz Sweeping                      |  | 0 0 0 0 1 1 | 44 | 24 | 12 |
| 50 | 560/1055Hz @ 3.3Hz Sweeping                       |  | 1 0 0 0 1 1 | 44 | 24 | 12 |
| 51 | 600/1250Hz @ 0.125Hz Sweeping                     |  | 0 1 0 0 1 1 | 44 | 24 | 12 |
| 52 | 660/1200Hz @ 1Hz Sweeping                         |  | 1 1 0 0 1 1 | 64 | 24 | 12 |
| 53 | 800/1000Hz @ 1Hz Sweeping                         |  | 0 0 1 0 1 1 | 56 | 24 | 12 |
| 54 | 800/1000Hz @ 7Hz Sweeping                         |  | 1 0 1 0 1 1 | 57 | 24 | 12 |
| 55 | 800/1000Hz @ 50Hz Sweeping                        |  | 0 1 1 0 1 1 | 54 | 24 | 12 |
| 56 | 2400/2900Hz @ 7Hz Sweeping                        |  | 1 1 1 0 1 1 | 57 | 24 | 12 |
| 57 | 2400/2900Hz @ 1Hz Sweeping                        |  | 0 0 0 1 1 1 | 47 | 24 | 12 |
| 58 | 2400/2900Hz @ 50Hz Sweeping                       |  | 1 0 0 1 1 1 | 54 | 24 | 12 |
| 59 | 2500/3000Hz @ 2Hz Sweeping                        |  | 0 1 0 1 1 1 | 44 | 24 | 12 |
| 60 | 2500/3000Hz @ 7.7Hz Sweeping                      |  | 1 1 0 1 1 1 | 44 | 24 | 12 |
| 61 | 800Hz Motor Siren                                 |  | 0 0 1 1 1 1 | 44 | 24 | 12 |
| 62 | 1200Hz Motor Siren                                |  | 1 0 1 1 1 1 | 44 | 24 | 12 |
| 63 | 2400Hz Motor Siren                                |  | 0 1 1 1 1 1 | 44 | 24 | 12 |
| 64 | Simulated Bell                                    |  | 1 1 1 1 1 1 | 44 | 21 | 12 |