

1) Warnings



- DO NOT OPEN WHEN AN EXPLOSIVE ATMOSPHERE IS PRESENT
- DO NOT OPEN WHEN ENERGISED
- POTENTIAL ELECTROSTATIC CHARGING HAZARD - CLEAN ONLY WITH A DAMP CLOTH
- DO NOT PAINT

Avertissement:

- NE PAS OUVRIR UN PRESENCE D'ATMOSPHERE EXPLOSIVE
- NE PAS OUVRIR ENERGIE
- DANGER POTENTIEL CHARGE ÉLECTROSTATIQUE - NETTOYER UNIQUEMENT AVEC UN CHIFFON HUMIDE
- NE PAS PENINTURER

2) Rating & Marking Information

2.1 Public Mode Fire Alarm Ratings

The D2xC2LD3DC024 is certified for use as a public mode audible and visual alarm device in accordance with UL464 Tenth Edition / CAN/ULC-S525 Fourth Edition and UL1638 Fifth Edition / CAN/ULC-S526 Fourth Edition.

For use in public-mode fire alarm systems the equipment must be installed without the wire guard or plastic lens cover on the beacon.

For light output ratings of the beacon see section 12.

The sounder section produces a sound pressure level above 75dB(A) at 10 feet:

For Fire Alarm applications, the Sounder Volume must be at the highest setting, (see volume control section).

The sounder section produces a sound pressure level above 75dB(A) at 10 feet.

For Fire Alarm applications, the Sounder Volume must be at the highest setting, (see volume control section).

For fire alarm use, the temporal pattern tone No. 12 as per the tone table provided in these instructions must be selected. This tone produces a minimum sound pressure level of:

CAN/ULC-S525: 100.4dB(A)* at 10 feet.
 (*Tested in an anechoic room)
 UL464: 92.2dB(A)_r at 10 feet.
 (+Tested in a reverberation room)

Testing of synchronization requirements of UL1971 & UL1638 / CAN/ULC-S526 were conducted by UL using a total of 6 units connected to the same wire run. Auto-synchronization does not require the use of any external sync modules or protocols. Providing the correct cable has been selected (see section 6) an unlimited number of units will remain synchronized when powered from the same source.

2.2 Private Mode Fire Alarm Ratings

The D2xC2LD3DC024 is approved for use as an Audible and Visual Appliance for use in Private Mode Fire Alarm System in accordance with UL464 Tenth Edition / CAN/ULC-S525 Fourth Edition and UL1638 Fifth Edition / CAN/ULC-S526 Fourth Edition.

For use in private-mode fire alarm systems the equipment must be installed without the wire guard or plastic lens cover on the beacon.

For light output ratings see section 12.

2.3 NEC & CEC Class / Division Ratings for US / Canada

The D2xC2LD3 LED beacon complies with the following standards:

UL1971 Ed. 3 2018
 UL1638 Ed. 5 2017 / CAN/ULC-S526 Ed. 4
 UL464 Ed. 10 2017 / CAN/ULC-S525 Ed. 4
 CSA C22.2 No. 205-17
 ANSI/ISA 12.12.01-2015
 CSA C22.2 No. 213-16

The D2xC2LD3 LED beacon is rated as follows:

Class I Div 2 ABCD T4 Ta -40°C to +50°C
 Class II Div 2 FG T6 Ta -40°C to +50°C
 Class III Div 1&2 Ta -40°C to +50°C

The certification approval has validated continuous use up to 38°C and are for transient use up to 50°C ambient.

Installation must be carried out in compliance with the National Electric Code / Canadian Electric Code

2.4 NEC Class / Zone ratings US

The D2xC2LD3 LED beacon complies with the following standards:

UL 60079-0-2017
 UL 60079-15-2017
 UL 60079-31-2015

The D2xC2LD3 LED beacon is rated as follows:

Class I Zone 2 AEx nA IIC Gc T4 Ta -40°C to +50°C
AEx tc IIIC 75°C Dc Ta -40°C to +50°C

Installation must be carried out in compliance with the National Electric Code.

2.5 CEC Class / Zone ratings Canada

The D2xC2LD3 LED beacon complies with the following standards:

CAN/CSA C22.2 No. 60079-0:2015
CAN/CSA C22.2 No. 60079-15:2016
CAN/CSA C22.2 No. 60079-31:2015

The D2xC2LD3 LED beacon is rated as follows:

Ex nA IIC Gc X T4 Ta -40°C to +50°C
Ex tc IIIC 75°C Dc X Ta -40°C to +50°C

Installation must be carried out in compliance with the Canadian Electric Code

2.6 ATEX / IECEx certification

The D2xC2LD3 LED beacon complies with the following standards:

EN60079-0:2012+A11:2013 / IEC60079-0: ed. 6.0 (2011-06)
EN60079-15:2010 / IEC60079-15: ed. 4.0 (2010-01)
EN60079-31:2014 / IEC60079-31:2013 ed. 2.0 (2013-11)

Certificate No. DEMKO 14 ATEX 4786493904X
IECEx ULD 14.0004X

The D2xC2LD3 LED beacon is rated as follows:



II 3G Ex nA IIC T4 Gc Ta -40°C to +50°C
II 3D Ex tc IIIC 75°C Dc Ta -40°C to +50°C

CE Marking



Zones, Gas / Dust Groups and Temperature Classification

When connected to an approved system the D2XC2LD3 LED beacon may be installed in:

Zone 2 explosive gas air mixture not likely to occur in normal operation, and if it does, it will only exist for a short time.

Zone 22 explosive dust air mixture not likely to occur in normal operation, and if it does, it will only exist for a short time.

May be used with gases in groups:

Group IIA propane
Group IIB ethylene
Group IIC hydrogen / acetylene

Having a temperature classification (for Gas applications) of:

T1 450°C
T2 300°C
T3 200°C
T4 135°C

May be used with Dust types:

Group IIIA combustible flyings
Group IIIB non-conductive dust
Group IIIC conductive dust

Maximum Surface Temperature for Dust Applications:

75°C

Installation must be carried out in compliance with the latest issue of the following standards:

EN60079-14 / IEC60079-14: Explosive atmospheres - Electrical installations design, selection and erection
EN60079-10-1 / IEC60079-10-1: Explosive atmospheres - Classification of areas. Explosive gas atmospheres
EN60079-10-2 / IEC60079-10-2: Explosive atmospheres - Classification of areas. Explosive dust atmospheres

2.7 Ingress Protection Ratings

The product is rated for ingress Protection as follows:

IP rating IP66
Type rating per UL50E / NEMA250: 4 / 4X / 3R / 13

To maintain the ingress protection rating, the cable entries must be fitted with suitably rated, certified cable entry and/or blanking devices during installation.

2.8 Electrical Ratings

It is important that a suitable power supply is used to run the equipment. The power supply selected must have the necessary capacity to provide the input current to all the units.

The input current will vary according to the voltage input level. The current levels shown above are for the worst-case input voltage and flash setting resulting in max. current.

For detailed current ratings of the device please see Section 13.

3) Special Conditions for Safe Use

Special Condition for safe Use as stated on the Type Examination Certificate DEMKO 14 ATEX 4786493904X / CoC/IECEx ULD 14.0004X:

When used for a Group III application, the surface of the enclosure may store electrostatic charge and become a source of ignition in applications with a low relative humidity <~30% relative humidity where the surface is relatively free of surface contamination such as dirt, dust, or oil.

Guidance on protection against the risk of ignition due to electrostatic discharge can be found in EN TR50404 and IEC TR60079-32.

End user shall adhere to the manufacturer's installation and instruction when performing housekeeping to avoid the potential for hazardous electrostatic charges during cleaning, by using a damp cloth.

To maintain the ingress protection rating and mode of protection, the cable entries must be fitted with suitably rated, certified cable entry and/or blanking devices during installation. If conduit is used for installation, seal conduit within 18 inches from the enclosure.

4) Location and Mounting

The location of the combined alarm horn and beacon should be made with due regard to the area over which the warning signal must be visible and audible. It should only be fixed to services that can carry the weight of the unit.

DxC2 Alarm Horn and Strobe to a flat surface via the two 9.7 x 6.7mm, 147mm pitch fixing holes in the mounting feet of the sounder section and the two 7mm fixing holes in the feet of the base.

The equipment is not to be mounted with the horn facing upwards.

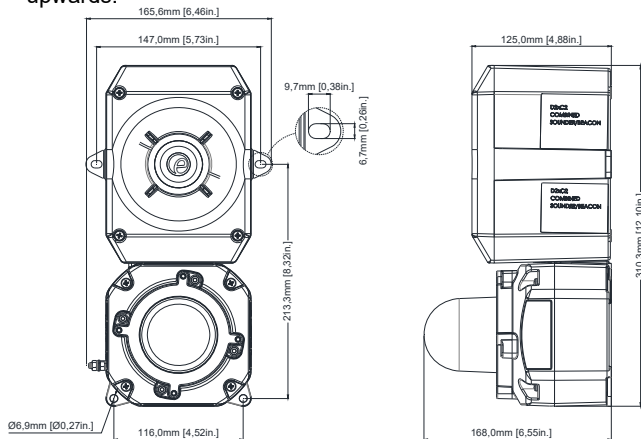

Fig. 1 Fixing locations.

5) Access to the Enclosure



Warning – High voltage may be present, risk of electric shock. DO NOT open when energised, disconnect power before opening.



Warning – Hot surfaces. External surfaces and internal components may be hot after operation, take care when handling the equipment.

To access the enclosures, loosen the four M4 posi pan head screws of the beacon and loosen the four M4 posi pan head screws of the sounder and withdraw the covers.

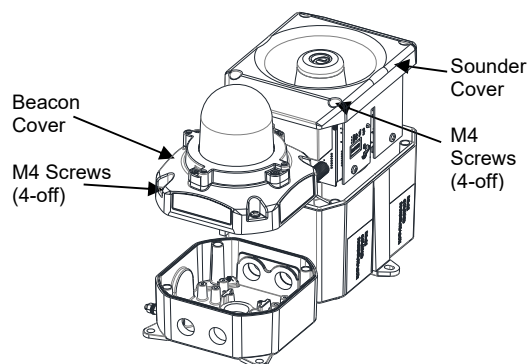

Fig. 2 Accessing the Enclosures.

To replace covers, check that the 'O' ring seals are in place. Carefully push the covers in place. Insert M4 screws with fibre washers and tighten to 3Nm torque.

6) Selection of Cable, Cable Glands, Blanking Elements & Adapters

When selecting the cable size, consideration must be given to the input current that each unit draws (see Table 1), the number of units on the line and the length of the cable runs. The cable size selected must have the necessary capacity to provide the input current to all of the sounders connected to the line.

When selecting the cable size consideration must be given to the voltage drop over the length of the cable run to ensure the min. input voltage at the point of use (voltage range, see section 13)

The voltage drop depends on:

- The total current draw of the devices installed on this cable run
- The wire size and total length of the cable run, determining the total resistance of this cable run
- The minimum output voltage supplied by the power supply

The voltage drop and input voltage at the point of use can be calculated as follows:

$$\text{Total Wire resistance} = \frac{\text{Wire resistance}}{1000\text{ft}} \times \text{length of cable run} \times 2$$

(length of cable run needs to be multiplied by two to account for two wires going to and from the unit)

$$\text{Total current draw} = \text{Current draw per unit} \times \text{number of units}$$

$$\text{Voltage Drop} = \text{Total current draw} \times \text{Total wire resistance}$$

$$\text{Minimum output of power supply} = \text{Min. voltage at point of use} + \text{voltage drop}$$

The entries are available as one of the following options:

- 2-off M20 x 1.5 thread & 1-off 3/4" NPT thread;
- 2-off 1/2" NPT thread & 1-off 3/4" NPT thread

If a high IP (Ingress Protection) rating is required then a suitable sealing washer must be fitted under the cable glands or blanking plugs.

For use in explosive dust atmospheres, a minimum ingress protection rating of IP6X must be maintained.

For use in explosive gas atmospheres, a minimum ingress protection rating of IP54 must be maintained.

NPT plugs should be greased before insertion.

7) Cable Connections

Electrical connections are to be made into the terminal blocks on the PCBAs located in the enclosures. See section 5 of this manual for access to the enclosures.

The Sounder and Beacon are supplied connected by default. In order to power the beacon and sounder separately, the link wires between the units must be disconnected.

Wires having a cross sectional area between 0.5 mm² to 2.5mm² can be connected to each terminal way. If an input and output wire is required the 2-off +/- terminals of the beacon or 3-off +/- terminals of the sounder can be used. If fitting 2-off wires to one terminal way the sum of the 2-off wires must be a maximum cross sectional area of 2.5mm². Strip wires to 8mm. Wires may also be fitted using ferrules. Terminal screws need to

be tightened down with a tightening torque of 0.56 Nm / 5 Lb-in. When connecting wires to the terminals great care should be taken to dress the wires so that when the cover is inserted into the chamber the wires do not exert excess pressure on the terminal blocks. This is particularly important when using cables with large cross sectional areas such as 2.5mm².

8) Wiring

8.2 Wiring Diagrams

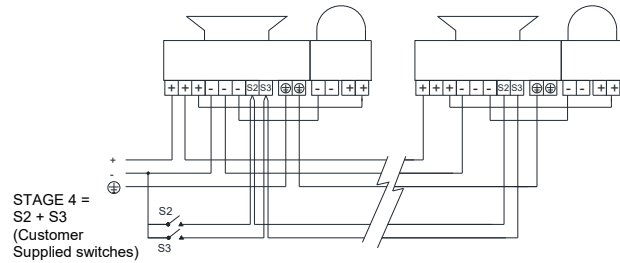

Fig. 3a Simplified Block Diagram Beacon & Sounder Powered Simultaneously

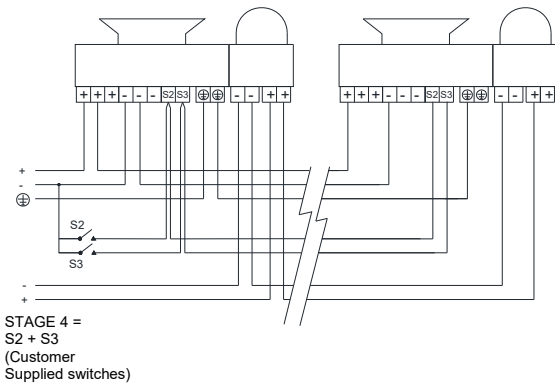

Fig. 3b Simplified Block Diagram Beacon & Sounder Powered Independently

8.3 Units First Stage Tones

Stage one (S1) operation: Simply connect the supply voltage to the + and - supply terminals, (see fig. 3). The beacon is powered via factory installed wires connected to the alarm horn. The wires connecting the alarm horn and strobe can be removed if the user wishes to power the strobe separately.

8.4 Second, Third and Fourth Stage Tone Selection

Stage two (S2) operation: Power +ve and -ve, link a -ve supply line to the S2 terminal.

Stage three (S3) operation: Power +ve and -ve, link a -ve supply line to the S3 terminal.

Stage four (S4) operation: Power +ve and -ve, link a -ve supply line to both the S2 & S3 terminals.

Strobe will continue to flash during alarm horn S2, S3 & S4 stages.

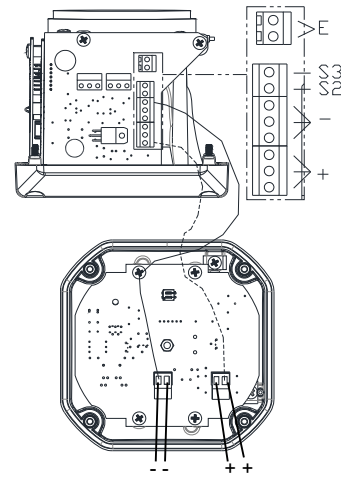

Fig. 4 Terminals

9) Earthing

The beacon has both internal and external earth points, (please see fig 5). The sounder PCBA also has earth terminals, (see fig 4).

Internal earthing connections should be made to the internal earth point on the beacon, (please see fig 5). The earth conductor should be at least equal in size and rating to the incoming power conductors. The internal earth bonding wires connect the covers to the internal earth points in the bases.

External earth connections should be made to the M5 earth stud, using a ring crimp terminal to secure the earth conductor to the earth stud. The external earth conductor should be at least 4mm² in size. The external earth crimp ring should be located between the two M5 plain washers provided and securely locked down with the M5 spring washer and M5 nut.

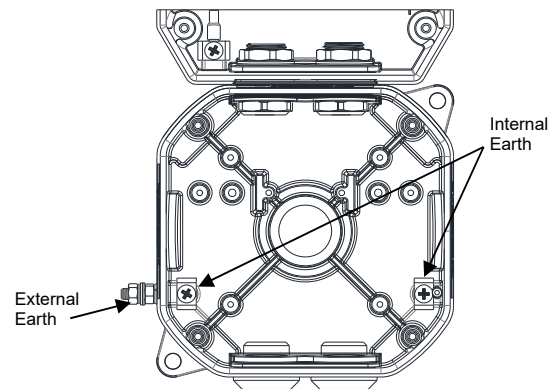

Fig. 5 Earth locations

10) End Of Line Monitoring

On DxC2 DC units, dc reverse line monitoring can be used if required. All DC units have a blocking diode fitted in their supply input lines. An end of line monitoring resistor can be connected across the +ve and -ve terminals. If an end of line resistor is used it must have the following values:-

24V DC Alarm Horn and Strobe

Minimum Resistance 3k9 ohms
Minimum Resistance 1k ohms

Minimum wattage 0.5W
Minimum wattage 2.0W

The resistor must be connected directly across the +ve and

-ve terminals of the PCBA, as shown in the following diagrams. Whilst keeping its leads as short as possible, a spacing of at least 1/16 inch (1.58mm) must be provided through air and over surfaces between uninsulated live parts.

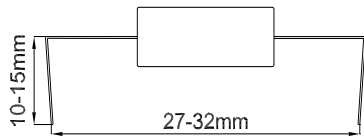

Fig. 6a End of Line Resistor Forming

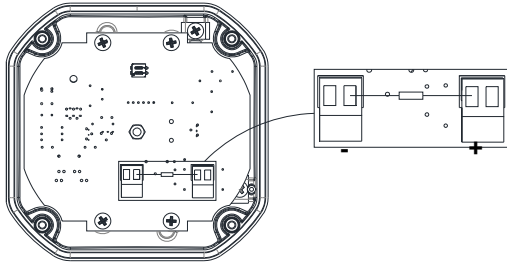

Fig. 6b End of Line Resistor Placement - Beacon

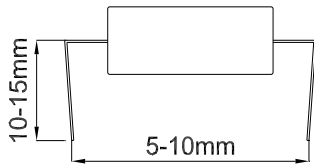

Fig. 7a End of Line Resistor Forming

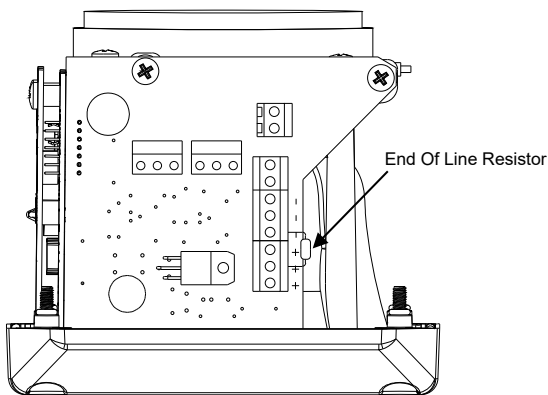

Fig. 7b End of Line Resistor Placement – Sounder

11) Setting

11.1 Volume Control

The alarm horn output level of the DxC2 unit can be set by adjusting the volume control potentiometer (see Fig 8). For maximum output, set the potentiometer fully clockwise.

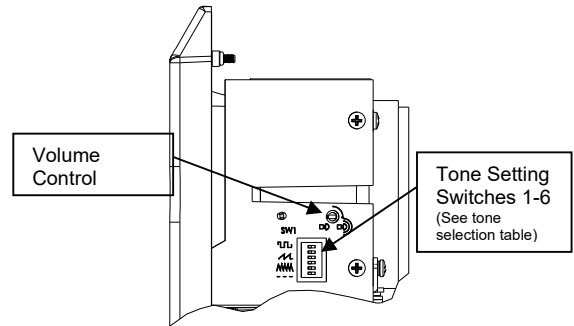

Fig. 8 Location of field controls

11.2 Tone Selection

The DxC2 alarm horns have 64 different tones. The tones are selected by operation of the tone setting DIP switches (see Fig. 9 & 10) on the PCB. The alarm horns can also be switched to sound the second, third and fourth stage alarm tones. The tone table (Table 1) shows the switch positions for the 64 tone and which tones are available for the second, third and fourth stages.

11.3 Flash Rate Setting



Warning – high-intensity light source. Avoid looking directly at the light source for extended periods of time.

The D2xC2LD3 beacons can produce different flash patterns as shown in Table 1. The flash patterns are selected by operation of the flash setting DIP switch on the PCB, Fig 10.

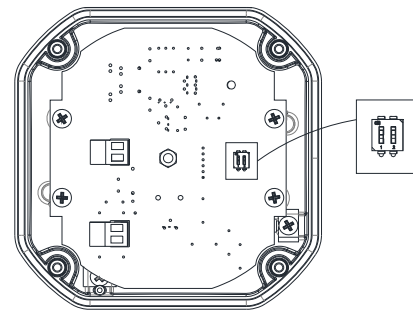

Fig. 9: DIP Switch Location

Switch Setting	Mode
00	1Hz (60FPM)
01	1.33Hz (80FPM)
10	1.5Hz (90FPM)
11	2Hz (120FPM)

1=ON; 0=OFF

Table 1: Switch Positions for Flash Patterns

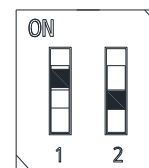

Fig. 10 Dip Switch

Example shown: 01 = Flashing 1.33Hz

12) Maintenance, Overhaul & Repair

Maintenance, repair and overhaul of the equipment should only be carried out by suitably qualified personnel in accordance with the current relevant standards:

IEC/EN60079-19 Explosive atmospheres - Equipment repair, overhaul and reclamation

IEC/EN60079-17 Explosive atmospheres - Electrical installations inspection and maintenance

To avoid a possible ELECTROSTATIC CHARGE the unit must only be cleaned with a damp cloth.

Units must not be opened while an explosive atmosphere is present.

If opening the unit during maintenance operations a clean environment must be maintained and any dust layer removed prior to opening the unit.

13) Light output for Fire alarm use

In order to meet the requirements for UL 1971, (D2xC2LD3DC024 only when used without plastic lens cover or wire guard), the installation must be carried out to the correct NFPA standards and guidelines.

13.1 Horizontal Light Output Dispersion for wall mounting – public mode

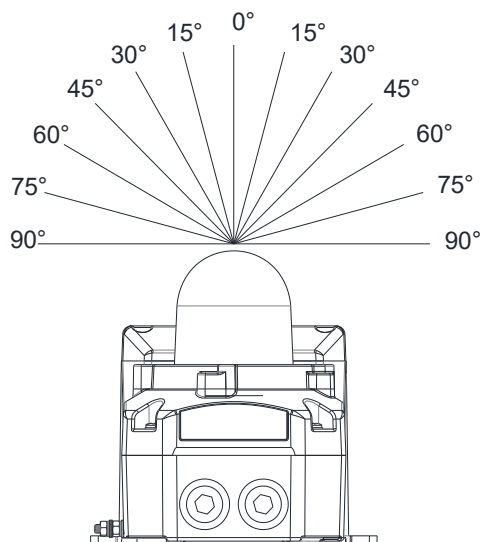

Fig. 12 – Horizontal dispersion angles for wall mounting

Table 3 - Horizontal Light Output Dispersion for Wall Mounting					
Viewing Angle	% Of Rating	Intensity (cd) at 1Hz flash rate	Intensity (cd) at 1.33Hz flash rate	Intensity (cd) at 1.5Hz flash rate	Intensity (cd) at 2Hz flash rate
0°	100	77.4	74.5	74.6	79.3
5°	90	69.6	67.0	67.2	71.4
10°	90	69.6	67.0	67.2	71.4
15°	90	69.6	67.0	67.2	71.4
20°	90	69.6	67.0	67.2	71.4
25°	90	69.6	67.0	67.2	71.4
30°	75	58.0	55.8	56.0	59.5
35°	75	58.0	55.8	56.0	59.5
40°	75	58.0	55.8	56.0	59.5
45°	75	58.0	55.8	56.0	59.5
50°	55	42.6	41.0	41.0	43.6
55°	45	34.8	33.5	33.6	35.7
60°	40	30.9	29.8	29.9	31.7
65°	35	27.1	26.1	26.1	27.8
70°	35	27.1	26.1	26.1	27.8
75°	30	23.2	22.3	22.4	23.8
80°	30	23.2	22.3	22.4	23.8
85°	25	19.3	18.6	18.7	19.8
90°	25	19.3	18.6	18.7	19.8
45° Compound	24	18.6	17.9	17.9	19.0

13.2 Vertical Light Output Dispersion for wall & ceiling mounting – public mode

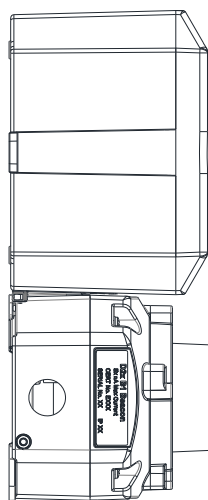

Fig 13 – Vertical dispersal angles for wall mounting X & Y planes

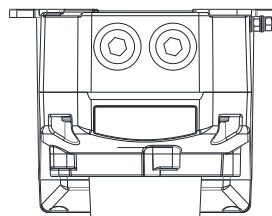

Fig 14 – Vertical dispersal angles for ceiling mounting X & Y planes

Table 5 – Vertical Light Output Dispersion for Ceiling Mounting					
Viewing Angle	% Of Rating	Intensity (cd) at 1Hz flash rate	Intensity (cd) at 1.33Hz flash rate	Intensity (cd) at 1.5Hz flash rate	Intensity (cd) at 2Hz flash rate
0°	100	77.4	74.5	74.6	79.3
5°	90	69.6	67.0	67.2	71.4
10°	90	69.6	67.0	67.2	71.4
15°	90	69.6	67.0	67.2	71.4
20°	90	69.6	67.0	67.2	71.4
25°	90	69.6	67.0	67.2	71.4
30°	75	58.0	55.8	56.0	59.5
35°	75	58.0	55.8	56.0	59.5
40°	75	58.0	55.8	56.0	59.5
45°	75	58.0	55.8	56.0	59.5
50°	55	42.6	41.0	41.0	43.6
55°	45	34.8	33.5	33.6	35.7
60°	40	30.9	29.8	29.9	31.7
65°	35	27.1	26.1	26.1	27.8
70°	35	27.1	26.1	26.1	27.8
75°	30	23.2	22.3	22.4	23.8
80°	30	23.2	22.3	22.4	23.8
85°	25	19.3	18.6	18.7	19.8
90°	25	19.3	18.6	18.7	19.8
45° Compound	24	18.6	17.9	17.9	19.0

All light output ratings min. values as per UL 1971 / UL1638 / CAN/ULC-S526 at worst-case (min.) input voltage.

13.3 On-axis light output rating – private mode

Model	Accessories	Intensity (cd) at 1Hz
D2xC2LD3DC024	No Guard, No Lens	107.5

14) Electrical Ratings

14.1 Operating current Consumption

Model	Nom. Voltage	Voltage Range	Flash Rate Setting	Nom. operating current [#]		Max. operating current ^{##}	
				Beacon	Sounder	Beacon	Sounder
D2xC2LD3DC024	24Vdc	Regulated (16-33Vdc)*	Flashing 1Hz	153mA	250mA	465mA	250mA
			Flashing 1.33Hz	189mA		488mA	
			Flashing 1.5Hz	203mA		456mA	
			Flashing 2Hz	248mA		528mA	

* For Public Mode or private mode Fire Alarm or General Signaling use

nominal rms current at nominal voltage

max. rms current at worst-case voltage in voltage range.

14.2 Surge current for Fire Alarm system use

Model	Nom. Voltage	Voltage Range	Flash Rate Setting	Init. Peak Surge Current*	Init. RMS Surge Current*
D2xC2LD3DC024	24Vdc	Regulated (16-33Vdc)	1Hz (60fpm)	1.18A	950mA
			1.33Hz (80fpm)	1.22A	998mA
			1.5Hz (90fpm)	1.2A	990mA
			2Hz (120fpm)	1.22A	980mA

Model	Nom. Voltage	Voltage Range	Init. Peak Surge Current*	Init. RMS Surge Current*
D2xC2LD3DC024	24Vdc	Regulated (16-33Vdc)	2.3A	930mA

*Surge currents at worst-case voltage in voltage range.

15) Sound Directional Characteristics for Canadian Fire CAN/ULC-S525

Angle	OSPL	Angle	OSPL
Reference (90°)	101.2 dB(A)	Reference (90°)	101.2 dB(A)
115°	-3 dB(A)	68°	-3 dB(A)
129°	-6 dB(A)	55°	-6 dB(A)
180°	92.4 dB(A)	0°	92.4

Angle	OSPL	Angle	OSPL
Reference (90°)	101.5 dB(A)	Reference (90°)	101.5 dB(A)
123°	-3 dB(A)	65°	-3 dB(A)
137°	-6 dB(A)	50°	-6 dB(A)
180°	91 dB(A)	0°	88.5 dB(A)

16) Tone Table

Tone Selection – To select the required first stage tone set the tone switches 1 to 6 (see Fig 2) to the tone setting shown in the table below. The table also shows which 2nd, 3rd and 4th stage tones are available for use with the selected first stage tone if more than one tone output stage is required.

Stage 1 Tone No	Tone Description	Tone Visual	Switch Settings 1 2 3 4 5 6	Stage 2 Tone (S2)	Stage 3 Tone (S3)	Stage 4 Tone (S2 + S3)
1	1000Hz PFEER Toxic Gas	1000Hz	0 0 0 0 0 0	3	2	44
2	1200/500Hz @ 1Hz DIN / PFEER P.T.A.P.	1200Hz 500Hz	1 0 0 0 0 0	1	3	44
3	1000Hz @ 0.5Hz(1s on, 1s off) PFEER Gen. Alarm	1000Hz	0 1 0 0 0 0	1	2	44
4	1.4KHz-1.6KHz 1s, 1.6KHz-1.4KHz 0.5s NF C 48-265	1600Hz 1400Hz	1 1 0 0 0 0	44	24	1
5	544Hz(100mS)/440Hz (400mS) NF S 32-001	544Hz 440Hz	0 0 1 0 0 0	52	19	1
6	1500/500Hz - (0.5s on, 0.5s off) x3 + 1s gap AS4428	1500Hz 500Hz	1 0 1 0 0 0	7	44	1
7	500-1500Hz Sweeping 2 sec on 1 sec off AS4428	1500Hz 500Hz	0 1 1 0 0 0	6	44	1
8	500/1200Hz @ 0.26Hz(3.3s on, 0.5s off) Netherlands - NEN 2575	1200Hz 500Hz	1 1 1 0 0 0	44	24	35
9	1000Hz (1s on, 1s off)x7 + (7s on, 1s off) IMO Code 1a	1000Hz	0 0 0 1 0 0	18	34	1
10	1000Hz (1s on, 1s off)x7 + (7s on, 1s off) IMO Code 1a	1000Hz	1 0 0 1 0 0	21	34	1
11	420Hz(0.5s on, 0.5s off)x3 + 1s gap ISO 8201 Temporal Pattern	420Hz	0 1 0 1 0 0	44	1	8
12	1000Hz(0.5s on, 0.5s off)x3 + 1s gap ISO 8201 Temporal Pattern	1000Hz	1 1 0 1 0 0	44	1	8
13	422/775Hz - (0.85s on, 0.5s off) x3 + 1s gap NFPA - Temporal Coded	775Hz 422Hz	0 0 1 1 0 0	44	1	8
14	1000/2000Hz @ 1Hz Singapore	2000Hz 1000Hz	1 0 1 1 0 0	23	3	35
15	300Hz Continuous	300Hz	0 1 1 1 0 0	44	24	35
16	440Hz Continuous	440Hz	1 1 1 1 0 0	44	24	35
17	470Hz Continuous	470Hz	0 0 0 0 1 0	44	24	35
18	500Hz Continuous IMO code 2 (Low)	500Hz	1 0 0 0 1 0	44	24	35
19	554Hz Continuous	554Hz	0 1 0 0 1 0	64	24	35
20	660Hz Continuous	660Hz	1 1 0 0 1 0	44	24	35
21	800Hz IMO code 2 (High)	800Hz	0 0 1 0 1 0	44	24	35
22	1200Hz Continuous	1200Hz	1 0 1 0 1 0	44	24	35
23	2000Hz Continuous	2000Hz	0 1 1 0 1 0	15	3	35
24	2400Hz Continuous	2400Hz	1 1 1 0 1 0	48	20	35
25	440 @0.83Hz (50 cycles/minute) Intermittent	440Hz	0 0 0 1 1 0	1	44	8
26	470 @0.9Hz - 1.1s Intermittent	470Hz	1 0 0 1 1 0	1	44	8
27	470Hz @5Hz - (5 cycles/second) Intermittent	470Hz	0 1 0 1 1 0	1	44	8
28	544Hz @ 1.14Hz - 0.875s Intermittent	470Hz	1 1 0 1 1 0	44	24	8
29	655Hz @ 0.875Hz Intermittent	655Hz	0 0 1 1 1 0	1	44	8
30	660Hz @0.28Hz - 1.8sec on, 1.8sec off Intermittent	660Hz	1 0 1 1 1 0	44	24	8
31	660Hz @3.34Hz - 150mS on, 150mS off Intermittent	660Hz	0 1 1 1 1 0	30	24	8

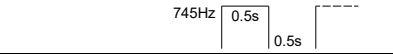
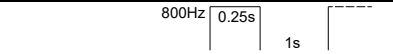
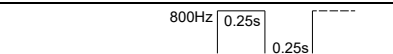
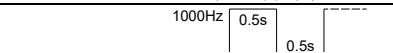
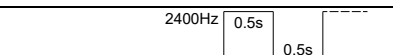
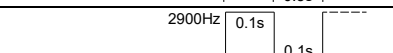
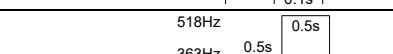
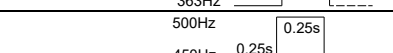
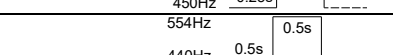
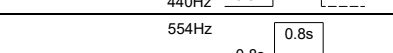
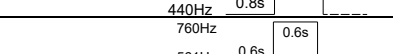
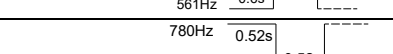
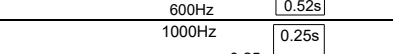
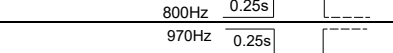
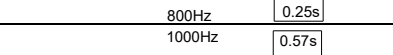
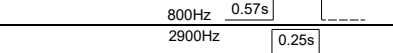
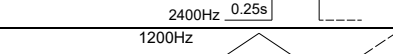
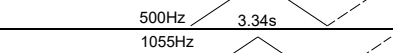
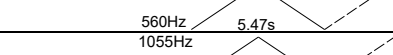
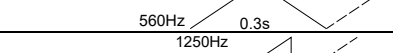
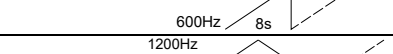
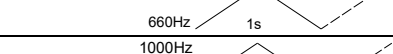
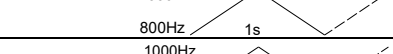
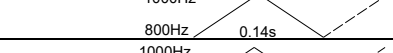
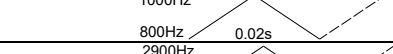
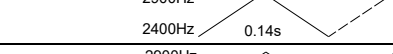
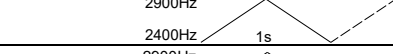
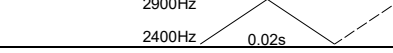
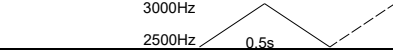
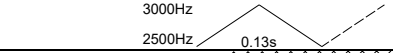
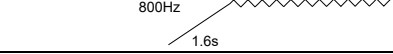
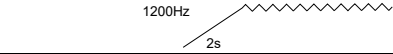
32	745Hz @ 1Hz Intermittent		1 1 1 1 1 0	44	24	8
33	800Hz - 0.25sec on, 1 sec off Intermittent		0 0 0 0 0 1	53	24	8
34	800Hz @ 2Hz IMO code 3.a (High) Intermittent		1 0 0 0 0 1	56	24	8
35	1000Hz @ 1Hz Intermittent		0 1 0 0 0 1	44	24	8
36	2400Hz @ 1Hz Intermittent		1 1 0 0 0 1	21	24	8
37	2900Hz @ 5Hz Intermittent		0 0 1 0 0 1	53	24	8
38	363/518Hz @ 1Hz Alternating		1 0 1 0 0 1	1	8	19
39	450/500Hz @ 2Hz Alternating		0 1 1 0 0 1	1	8	19
40	554/440Hz @ 1Hz Alternating		1 1 1 0 0 1	44	24	19
41	554/440Hz @ 0.625Hz Alternating		0 0 0 1 0 1	1	8	19
42	561/760Hz @ 0.83Hz (50 cycles/minute) Alternating		1 0 0 1 0 1	1	8	19
43	780/600Hz @ 0.96Hz Alternating		0 1 0 1 0 1	1	8	19
44	800/1000Hz @ 2Hz Alternating		1 1 0 1 0 1	5	24	19
45	970/800Hz @ 2Hz Alternating		0 0 1 1 0 1	1	8	19
46	800/1000Hz @ 0.875Hz Alternating		1 0 1 1 0 1	53	24	19
47	2400/2900Hz @ 2Hz Alternating		0 1 1 1 0 1	57	24	19
48	500/1200Hz @ 0.3Hz Sweeping		1 1 1 1 0 1	44	24	12
49	560/1055Hz @ 0.18Hz Sweeping		0 0 0 0 1 1	44	24	12
50	560/1055Hz @ 3.3Hz Sweeping		1 0 0 0 1 1	44	24	12
51	600/1250Hz @ 0.125Hz Sweeping		0 1 0 0 1 1	44	24	12
52	660/1200Hz @ 1Hz Sweeping		1 1 0 0 1 1	64	24	12
53	800/1000Hz @ 1Hz Sweeping		0 0 1 0 1 1	56	24	12
54	800/1000Hz @ 7Hz Sweeping		1 0 1 0 1 1	57	24	12
55	800/1000Hz @ 50Hz Sweeping		0 1 1 0 1 1	54	24	12
56	2400/2900Hz @ 7Hz Sweeping		1 1 1 0 1 1	57	24	12
57	2400/2900Hz @ 1Hz Sweeping		0 0 0 1 1 1	47	24	12
58	2400/2900Hz @ 50Hz Sweeping		1 0 0 1 1 1	54	24	12
59	2500/3000Hz @ 2Hz Sweeping		0 1 0 1 1 1	44	24	12
60	2500/3000Hz @ 7.7Hz Sweeping		1 1 0 1 1 1	44	24	12
61	800Hz Motor Siren		0 0 1 1 1 1	44	24	12
62	1200Hz Motor Siren		1 0 1 1 1 1	44	24	12
63	2400Hz Motor Siren		0 1 1 1 1 1	44	24	12
64	Simulated Bell		1 1 1 1 1 1	44	21	12