

INSTRUCTION & SERVICE MANUAL

DL105X AlertAlight Combined Sounder Xenon Beacons

- -40°C to +66C (-40°F to 151°F)
- Type 4 / 4X / 3R / 13, IP66
- 2.1Kg (4.62lb)
- CE, UKCA
- All units UL Listed.

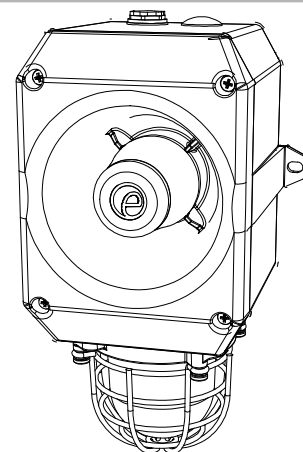

Unit Type Code	Nominal Voltage	Voltage Range	Nominal Sounder Current*	Nominal Beacon Current*	Nominal SPL	Max SPL	Average SPL
DL105XDC012	12 V dc	11.5-14V dc	17mA	341mA	105.3dB(A) Tone 44 @ 1m	110.9dB(A) Tone 4 @ 1m	105.2dB(A) All tones @1m
DL105XDC024	24V dc	20-28V dc	33.5mA	271mA			
DL105XDC048	48V dc	42-52V dc	113mA	170mA			
DL105XAC024	24V ac	24-28V ac 50/60Hz	42.5mA	300mA			
DL105XAC048	48V ac	48V ac ± 10% 50/60Hz	42mA	250mA			
DL105XAC115	115V ac	115V ac ± 10% 50/60Hz	25mA	70mA			
DL105XAC230	230V ac	230V ac ± 10% 50/60Hz	17mA	35mA			

*Nominal current at nominal voltage, Tone 12 / 1Hz Flash Pattern

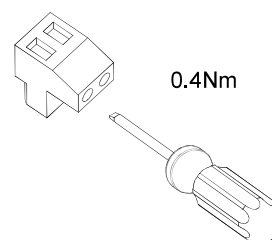
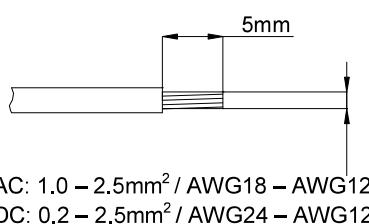

Attention: Installation must be carried out by an electrician in compliance with the latest codes and regulations.

Attention: L'installation doit être effectuée par un électricien conformément aux derniers codes et réglementations.

Achtung: Die Installation muss von einem Elektriker gemäß den neuesten Vorschriften und Bestimmungen durchgeführt werden.

Attenzione: L'installazione deve essere eseguita da un elettricista in conformità con i codici e le normative più recenti.

Atención: La instalación debe ser realizada por un electricista de acuerdo con los últimos códigos y regulaciones.

Atenção: A instalação deve ser realizada por um eletricista de acordo com os códigos e regulamentos mais recentes.

ВНИМАНИЕ: установка должна выполняться электриком в соответствии с последними нормами и правилами.



Attention: Disconnect from power source before installation or service to prevent electric shock

Attention: Débranchez-le de la source d'alimentation avant l'installation ou l'entretien pour éviter tout choc électrique.

Achtung: Vor Installation oder Wartung von der Stromquelle trennen, um einen Stromschlag zu vermeiden.

Attenzione: scollegare dall'alimentazione prima dell'installazione o dell'assistenza per evitare scosse elettriche.

Atención: desconéctelo de la fuente de alimentación antes de la instalación o el servicio para evitar descargas eléctricas.

Atenção: Desconecte da fonte de alimentação antes da instalação ou serviço para evitar choque elétrico

ВНИМАНИЕ: отключите от источника питания перед установкой или обслуживанием, чтобы предотвратить поражение электрическим током.



AC

(See D218-06-205)

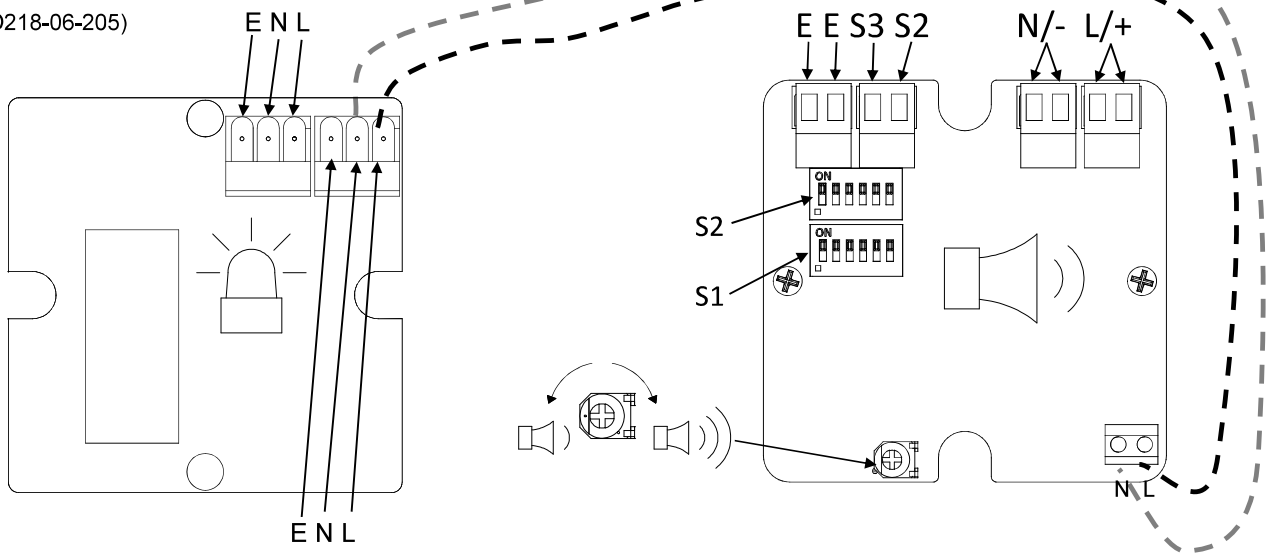

DC

(See D218-06-201)

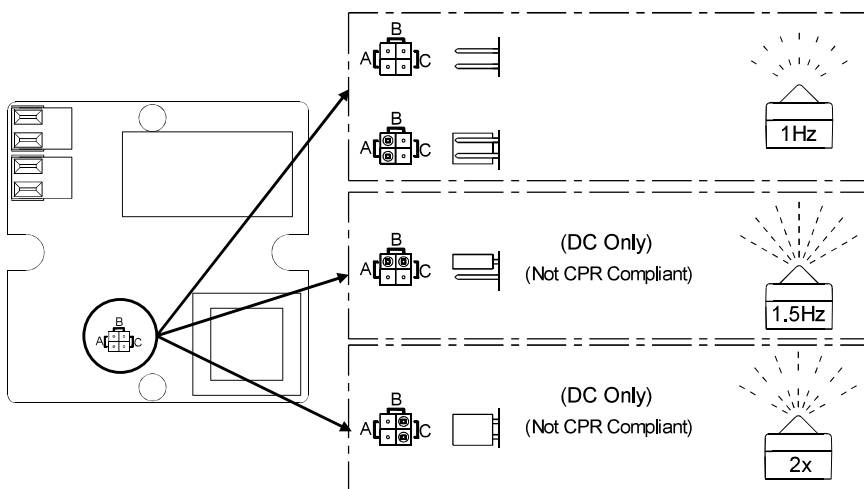
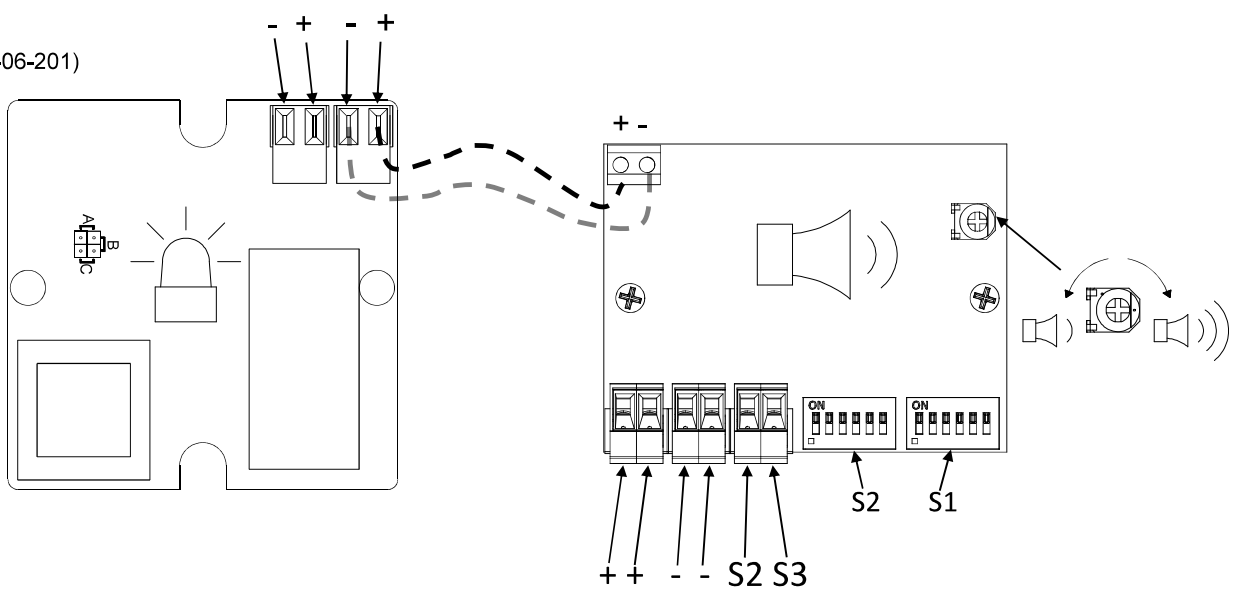

(AC & DC, See D221-95-001)

Default = S2 - Tone 1

Default = S1 - Tone 44

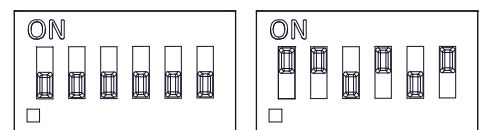

(ON = 1, OFF = 0)

INSTRUCTION & SERVICE MANUAL
DL105X AlertAlight Combined Sounder Xenon Beacons

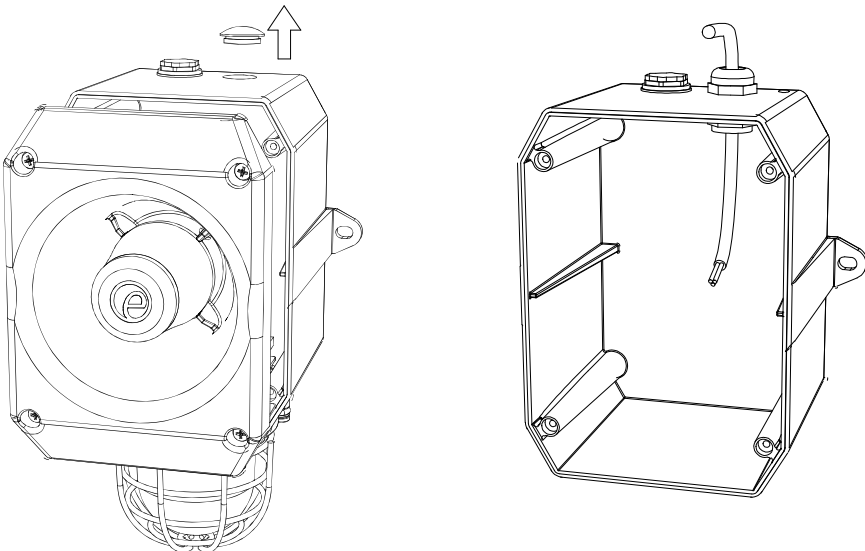
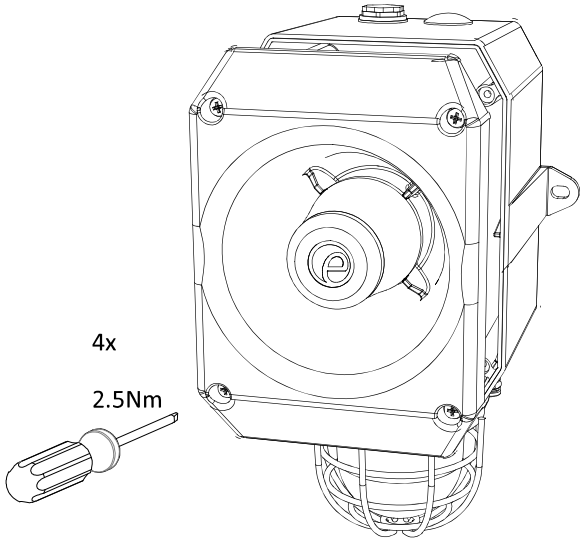

For DL105XAC units wire an Earth to the E terminal on the PCBA in order to Earth the metal housing.

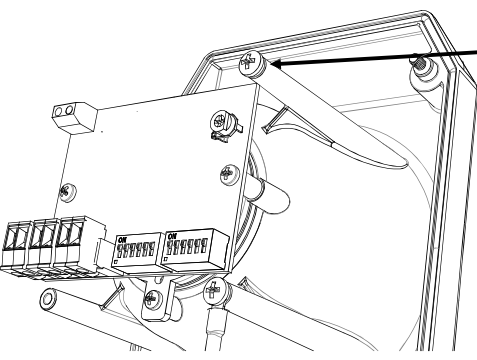

For DL105XDC units, using a ring terminal, fit an Earth to the shown location underneath the M4 screw and M4 spring washer. This point shall not be used for any other purpose (e.g. ground bonding).

- All models are approved for use as Audible Signal and Visual Appliance for use as General Signaling: UL464A & CSA C22.2 No 205-17
- Type 4 / 4X / 3R / 13, IP66
- -40°C to +66°C / -40°C to +151°F
 General Signaling Canada:
 DL105XDC: -40°C to +55°C / -40°F to +131°F
 DL105XAC: -40°C to +40°C / -40°F to +104°F



- To maintain Ingress Protection, cable entries must be fitted with suitably rated cable glands or stopping plugs
- Mounting - Units can be mounted using the 2-off 10 x 7mm obround holes in the mounting lugs.
- EOL Monitoring (DC Only): End of Line Devices may be fitted between the +ve & -ve terminals of the PCBA. Please ensure that the device legs meet the wire size range stated for the connection terminals and are fitted correctly in order to avoid a short. Refer to the compatible control panel specification for EOL device values and ratings

Model	Nominal Voltage	Voltage Range	Nominal Operating Current*		Max Operating RMS#	
			Beacon	Sounder	Beacon	Sounder
DL105XDC012	12V dc	11.5-14Vdc	341mA	17mA	531mA	125mA
DL105XDC024	24V dc	20-28Vdc	250mA	33.5mA	271mA	
DL105XDC048	48V dc	42-52Vdc	170mA	113mA	170mA	
DL105XAC024	24V ac	24-28Vac 50/60Hz	300mA	42.5mA	426mA	42.5mA
DL105XAC048	48V ac	42-54Vac 50/60Hz	250mA	42mA	360mA	
DL105XAC115	115 Vac	103.5-126.5Vac 50/60Hz	70mA	25mA	101mA	
DL105XAC230	230 Vac	207-253Vac 50/60Hz	35mA	17mA	58mA	

*Nominal Voltage, 1Hz Flash Pattern & Tone 12; #Worst-case input voltage and worst case flash pattern



Attention: Installation must be carried out by an electrician in compliance with the National Electrical Code, NFPA 70 or CSA 22.1 Canadian Electrical Code, Part I, Safety Standard for Electrical Installations, Section 32. / L'installation doit exclusivement être réalisée par du personnel qualifié, conformément au code national d'électricité américain, NFPA 70 ou CSA 22.1 Code canadien de l'électricité, première partie, norme de sécurité relative aux installations électriques, Section 32

Stage 1 Set DIP SW 1 Tone No.	Tone Description	Tone Visual	Stage 1 & 2 DIP SW 1/2 Settings 1 2 3 4 5 6	Stage 3 Set DIP SW 1 (S3)	Stage 4 Set DIP SW 1 (S2 + S3)
1	1000Hz PFEER Toxic Gas		0 0 0 0 0 0	2	44
2	1200/500Hz @ 1Hz DIN /PFEER P.T.A.P.		1 0 0 0 0 0	3	44
3	1000Hz @ 0.5Hz(1s on, 1soff) PFEER Gen. Alarm		0 1 0 0 0 0	2	44
4	1.4KHz-1.6KHz 1s, 1.6KHz-1.4KHz 0.5s NF C 48-265		1 1 0 0 0 0	24	1
5	544Hz(100mS)/440Hz (400mS) NF S 32-001		0 0 1 0 0 0	19	1
6	1500/500Hz - (0.5s on , 0.5s off) x3 + 1s gap AS4428		1 0 1 0 0 0	44	1
7	500-1500Hz Sweeping 2 sec on 1 sec off AS4428		0 1 1 0 0 0	44	1
8	500/1200Hz @ 0.26Hz (3.3son, 0.5s off) Netherlands - NEN 2575		1 1 1 0 0 0	24	35
9	1000Hz (1s on, 1s off)x7 + (7s on, 1s off) IMO Code 1a		0 0 0 1 0 0	34	1
10	1000Hz (1s on, 1s off)x7 + (7s on, 1s off) IMO Code 1a		1 0 0 1 0 0	34	1
11	420Hz(0.5s on, 0.5s off)x3 + 1s gap ISO 8201 Temporal Pattern		0 1 0 1 0 0	1	8
12	1000Hz(0.5s on, 0.5s off)x3 + 1s gap ISO 8201 Temporal Pattern		1 1 0 1 0 0	1	8
13	422/775Hz - (0.85 on, 0.5 off) x3 + 1s gap NFPA - Temporal Coded		0 0 1 1 0 0	1	8
14	1000/2000Hz @ 1Hz Singapore		1 0 1 1 0 0	3	35
15	300Hz Continuous (f=300)		0 1 1 1 0 0	24	1
16	440Hz Continuous (f=440)		1 1 1 1 0 0	24	1
17	470Hz Continuous (f=470)		0 0 0 0 1 0	24	8
18	500Hz Continuous IMO code 2 (Low) (f=500)		1 0 0 0 1 0	24	8
19	554Hz Continuous (f=554)		0 1 0 0 1 0	24	8
20	660Hz Continuous (f=660)		1 1 0 0 1 0	24	35
21	800Hz IMO code 2 (High) (f=800)		0 0 1 0 1 0	24	35
22	1200Hz Continuous (f=1200)		1 0 1 0 1 0	24	35
23	2000Hz Continuous (f=2000)		0 1 1 0 1 0	3	35
24	2400Hz Continuous (f=2400)		1 1 1 0 1 0	20	35
25	440Hz @0.83Hz (50 cycles/minute) Intermittent (f=440, a=0.6, b=0.6)		0 0 0 1 1 0	44	8
26	470Hz @0.9Hz - 1,1s Intermittent (f=470, a=0.55, b=0.55)		1 0 0 1 1 0	44	8
27	470Hz @5Hz - (5 cycles/second) Intermittent (f=470, a=0.1, b=0.1)		0 1 0 1 1 0	44	8
28	544Hz @ 1,14Hz - 0,875s Intermittent (f=470, a=0.43, b=0.44)		1 1 0 1 1 0	24	8
29	655Hz @ 0,875Hz Intermittent (f=655, a=0.57, b=0.57)		0 0 1 1 1 0	24	8
30	660Hz @0,28Hz - 1,8sec on, 1,8sec off Intermittent (f=660, a=1.8, b=1.8)		1 0 1 1 1 0	24	8
31	660Hz @3,34Hz - 150mS on, 150mS off Intermittent (f=660, a=0.15, b=0.15)		0 1 1 1 1 0	24	8
32	745Hz @ 1Hz Intermittent (f=745, a=0.5, b=0.5)		1 1 1 1 1 0	24	8
33	800Hz - 0,25sec on, 1 sec off Intermittent (f=800, a=0.25, b=1)		0 0 0 0 0 1	24	8
34	800Hz @ 2Hz IMO code 3,a (High) Intermittent (f=800, a=0.25, b=0.25)		1 0 0 0 0 1	24	19
35	1000Hz @ 1Hz Intermittent (f=1000, a=0.5, b=0.5)		0 1 0 0 0 1	24	19
36	2400Hz @ 1Hz Intermittent (f=2400, a=0.5, b=0.5)		1 1 0 0 0 1	24	19
37	2900Hz @ 5Hz Intermittent (f=2900, a=0.1, b=0.1)		0 0 1 0 0 1	24	19
38	363/518Hz @ 1Hz Alternating (f=363, f1=518, a=0.1)		1 0 1 0 0 1	8	19
39	450/500Hz @ 2Hz Alternating (f=450, f1=500, a=0.25)		0 1 1 0 0 1	8	19
40	554/440Hz @ 1Hz Alternating (f=440, f1=554, a=0.5)		1 1 1 0 0 1	24	19
41	554/440Hz @ 0.625Hz Alternating (f=440, f1=554, a=0.8)		0 0 0 1 0 1	8	19
42	561/760Hz @0.83Hz (50 cycles/minute) Alternating (f=561, f1=760, a=0.6)		1 0 0 1 0 1	8	19
43	780/600Hz @ 0.96Hz Alternating (f=600, f1=780, a=0.52)		0 1 0 1 0 1	8	19
44	800/1000Hz @ 2Hz Alternating (f=800, f1=1000, a=0.25)		1 1 0 1 0 1	24	19
45	970/800Hz @ 2Hz Alternating (f=800, f1=970, a=0.25)		0 0 1 1 0 1	8	19
46	800/1000Hz @ 0.875Hz Alternating (f=800, f1=1000, a=0.57)		1 0 1 1 0 1	24	19
47	2400/2900Hz @ 2Hz Alternating (f=2400, f1=2900, a=0.25)		0 1 1 1 0 1	24	19
48	500/1200Hz @ 0,3Hz Sweeping (f=500, f1=1200, a=3,34)		1 1 1 1 0 1	24	12
49	560/1055Hz @ 0,18Hz Sweeping (f=560, f1=1055, a=5,47)		0 0 0 0 1 1	24	12
50	560/1055Hz @ 3,3Hz Sweeping (f=560, f1=1055, a=0.3)		1 0 0 0 1 1	24	12
51	600/1250Hz @ 0,125Hz Sweeping (f=600, f1=1250, a=8)		0 1 0 0 1 1	24	12
52	660/1200Hz @ 1Hz Sweeping (f=660, f1=1200, a=1)		1 1 0 0 1 1	24	12
53	800/1000Hz @ 1Hz Sweeping (f=800, f1=1000, a=1)		0 0 1 0 1 1	24	12
54	800/1000Hz @ 7Hz Sweeping (f=800, f1=1000, a=0.14)		1 0 1 0 1 1	24	12
55	800/1000Hz @ 50Hz Sweeping (f=800, f1=1000, a=0.02)		0 1 1 0 1 1	24	12
56	2400/2900Hz @ 7Hz Sweeping (f=2400, f1=2900, a=0.14)		1 1 1 0 1 1	24	12
57	2400/2900Hz @ 1Hz Sweeping (f=2400, f1=2900, a=1)		0 0 0 1 1 1	24	12
58	2400/2900Hz @ 50Hz Sweeping (f=2400, f1=2900, a=0.02)		1 0 0 1 1 1	24	12
59	2500/3000Hz @ 2Hz Sweeping (f=2500, f1=3000, a=0.5)		0 1 0 1 1 1	24	12
60	2500/3000Hz @ 7,7Hz Sweeping (f=2500, f1=3000, a=0.13)		1 1 0 1 1 1	24	12
61	800Hz Motor Siren (f=800, a=1.6)		0 0 1 1 1 1	24	12
62	1200Hz Motor Siren (f=1200, a=2)		1 0 1 1 1 1	24	12
63	2400Hz Motor Siren (f=2400, a=1.7)		0 1 1 1 1 1	24	12
64	Simulated Bell		1 1 1 1 1 1	21	12

1	2	3	4	5	6	7	8	9	10
<p style="text-align: center;">WIRING LINKING BEACON & SOUNDER FACTORY FITTED</p>									
<p style="text-align: center;">OPTIONAL LINE MONITORING RESISTOR, CUSTOMER SUPPLIED. RECOMMENDED MINIMUM VALUES: 14V MAX SYSTEM = 120Ω MIN, 2W MIN OR 1KΩ MIN, 0.5W MIN 28V MAX SYSTEM = 470Ω MIN, 2W MIN OR 2.4KΩ MIN, 0.5W MIN</p>									
ISSUE		MOD No.		REASON - INITIAL - DATE					
A				INTRODUCTION RSR - 11/05/2021					
B				AMENDED NOTES 1b & 1c RSR - 24/01/2023					

Linked Sounder & Beacon Activation (Default)

Single Stage Configuration Line Monitoring Stage 1: Apply Power to Stage 1 +ve & Stage 1 -ve		Config.: 1a Two Stage Configuration Common Positive Stage 1: Apply Power to Common +ve & Stage 1 -ve Stage 2: Apply Power to Common +ve & Stage 1 -ve & connect Stage 2 -ve to Stage 1 -ve		Config.: 1b Three/Four Stage Configuration Common Positive Stage 1: Apply Power to Common +ve & Stage 1 -ve Stage 2: Apply Power to Common +ve & Stage 1 -ve & connect Stage 2 -ve to Stage 1 -ve Stage 3: Apply Power to Common +ve & Stage 1 -ve & connect Stage 3 -ve to Stage 1 -ve Stage 4: Apply Power to Common +ve & Stage 1 -ve & connect Stage 2 -ve & Stage 3 -ve to Stage 1 -ve		Config.: 1c	
Stage 1 +ve IN Stage 1 +ve OUT Stage 1 -ve OUT Stage 1 -ve IN		Common +ve IN Common +ve OUT Stage 1 -ve OUT Stage 1 -ve IN Stage 2 -ve		Common +ve IN Common +ve OUT Stage 1 -ve OUT Stage 1 -ve IN Stage 2 -ve Stage 3 -ve		Common +ve IN Common +ve OUT Stage 1 -ve OUT Stage 1 -ve IN Stage 2 -ve Stage 3 -ve	

DRAWING TO BS8888:2000 GEOMETRIC TOLERANCES TO ISO1101:1983 LINEAR DIMENSIONAL TOLS ANGULAR DIMENSIONAL TOLS	DRAWN	DATE	SURFACE FINISH	WEIGHT (kg)
	R.S.RAIT	16/03/2021	MATERIAL	
STANDARDS ALERTALARM RANGE	CHECKED	DATE	ALTERNATIVE MATERIAL	
	B.ISARD	16/03/2021		
ALERTALARM RANGE	APPROVED	DATE	ALTERNATIVE MATERIAL	
	R.N.POTTS	16/03/2021		
THIS DRAWING AND ANY INFORMATION OR DESCRIPTIVE MATTER THEREIN IS COMMUNICATED IN CONFIDENCE AND IS THE PROPERTY OF EUROPEAN SAFETY SYSTEMS LTD. NO PART OF THIS DRAWING OR ANY EXTRACT MAY BE DISCLOSED, LOANED, COPIED OR USED FOR MANUFACTURING OR TENDERING PURPOSES WITHOUT THEIR WRITTEN CONSENT.				
© EUROPEAN SAFETY SYSTEMS LTD. AS PER LATEST DATE OF ISSUE SHOWN ABOVE				
EUROPEAN SAFETY SYSTEMS LTD MANES HOUSE LONDON W3 7QH WWW.E2S.COM				
ALL DIMENSIONS IN MM IF IN DOUBT, ASK - DO NOT SCALE			A3	
TITLE AL100X, AL105NX & DL105X DC COMBINED SOUNDER & XENON WIRING DIAGRAMS			SCALE SHEET DRAWING NUMBER NTS 1 OF 2 D218-06-201	

1	2	3	4	5	6	7	8	9	10
<p>OPTIONAL LINE MONITORING RESISTOR, CUSTOMER SUPPLIED, RECOMMENDED MINIMUM VALUES: 14V MAX SYSTEM = 120Ω MIN, 2W MIN OR 1KΩ MIN, 0.5W MIN 28V MAX SYSTEM = 470Ω MIN, 2W MIN OR 2.4KΩ MIN, 0.5W MIN</p>									
<p>ISSUE MOD No. REASON - INITIAL - DATE</p> <p>A INTRODUCTION RSR - 11/05/2021</p> <p>B AMENDED NOTES 1b & 1c RSR - 24/01/2023</p>									

Independent Sounder & Beacon Activation (Remove Link Wires)

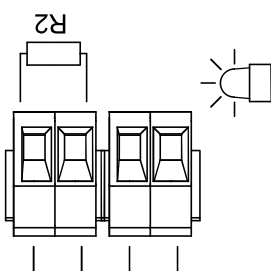
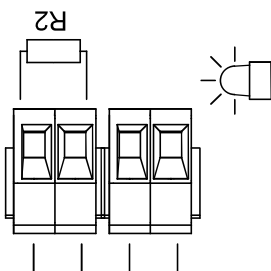
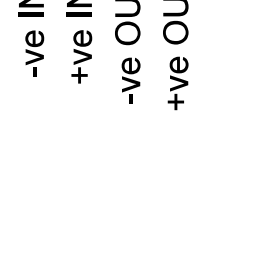
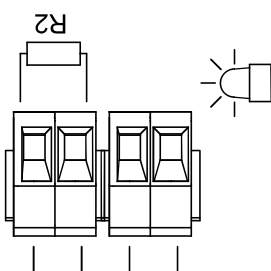
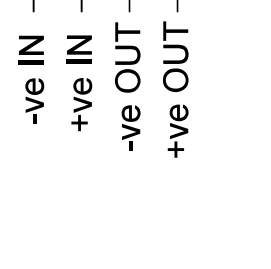
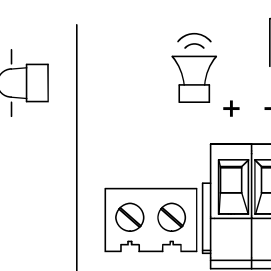
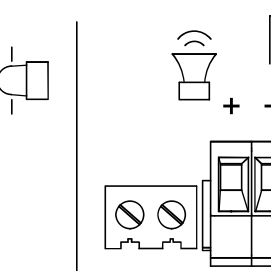
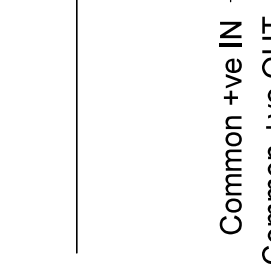
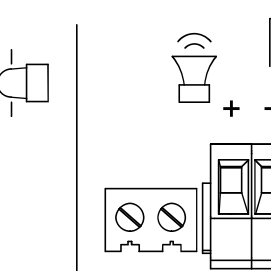
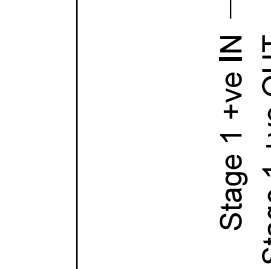
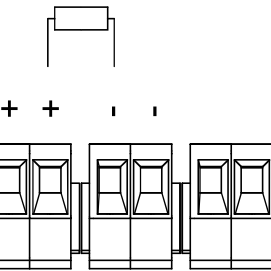
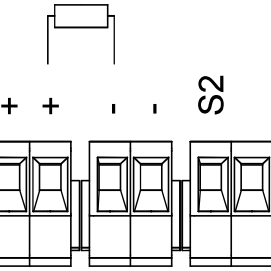
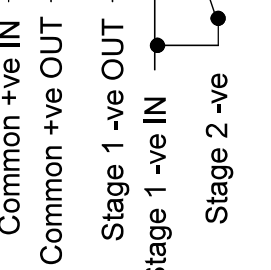
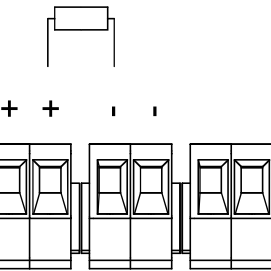
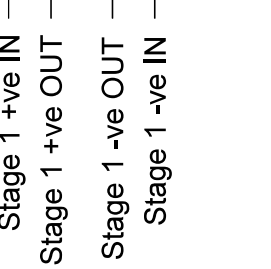
<p>Single Stage Configuration Line Monitoring</p>	<p>Config.: 5a</p>	<p>Two Stage Configuration Common Positive</p>	<p>Config.: 5b</p>	<p>Three/Four Stage Configuration Common Positive</p>	<p>Config.: 5c</p>
<p>Stage 1: Apply Power to Stage 1 +ve & Stage 1 -ve</p>	<p>Stage 1: Apply Power to Common +ve & Stage 1 -ve Stage 2: Apply Power to Common +ve & Stage 1 -ve & connect Stage 2 -ve to Stage 1 -ve</p>	<p>Stage 1: Apply Power to Common +ve & Stage 1 -ve Stage 2: Apply Power to Common +ve & Stage 1 -ve & connect Stage 2 -ve to Stage 1 -ve</p>	<p>Stage 1: Apply Power to Common +ve & Stage 1 -ve Stage 2: Apply Power to Common +ve & Stage 1 -ve & connect Stage 2 -ve to Stage 1 -ve Stage 3: Apply Power to Common +ve & Stage 1 -ve & connect Stage 3 -ve to Stage 1 -ve Stage 4: Apply Power to Common +ve & Stage 1 -ve & connect Stage 2 -ve & Stage 3 -ve to Stage 1 -ve</p>	<p>Stage 1: Apply Power to Common +ve & Stage 1 -ve Stage 2: Apply Power to Common +ve & Stage 1 -ve & connect Stage 2 -ve to Stage 1 -ve Stage 3: Apply Power to Common +ve & Stage 1 -ve & connect Stage 3 -ve to Stage 1 -ve Stage 4: Apply Power to Common +ve & Stage 1 -ve & connect Stage 2 -ve & Stage 3 -ve to Stage 1 -ve</p>	
<p>-ve IN +ve IN -ve OUT +ve OUT</p> 	<p>-ve IN +ve IN -ve OUT +ve OUT</p> 	<p>-ve IN +ve IN -ve OUT +ve OUT</p> 	<p>-ve IN +ve IN -ve OUT +ve OUT</p> 	<p>-ve IN +ve IN -ve OUT +ve OUT</p> 	
<p>Stage 1 +ve IN Stage 1 +ve OUT Stage 1 -ve OUT Stage 1 -ve IN</p> 	<p>Common +ve IN Common +ve OUT Stage 1 -ve OUT Stage 1 -ve IN</p> 	<p>Common +ve IN Common +ve OUT Stage 1 -ve OUT Stage 1 -ve IN</p> 	<p>Common +ve IN Common +ve OUT Stage 1 -ve OUT Stage 1 -ve IN</p> 	<p>Common +ve IN Common +ve OUT Stage 1 -ve OUT Stage 1 -ve IN</p> 	
<p>Stage 2 -ve Stage 3 -ve</p> 	<p>Stage 2 -ve</p> 	<p>Stage 2 -ve</p> 	<p>Stage 2 -ve Stage 3 -ve</p> 	<p>Stage 2 -ve Stage 3 -ve</p> 	

<p>DRAWING TO BS8888:2000 GEOMETRIC TOLERANCES TO ISO1101:1983 LINEAR DIMENSIONAL TOLS ANGULAR DIMENSIONAL TOLS</p>	<p>DRAWN R.S. RAIT CHECKED B. ISARD APPROVED R.N. POTTS</p>	<p>DATE 16/03/2021 DATE 16/03/2021 DATE 16/03/2021</p>	<p>SURFACE FINISH WEIGHT (kg) MATERIAL</p>	<p>ALTERNATIVE MATERIAL</p>	<p>STANDARDS ALERTALARM RANGE</p>
<p>ALL DIMENSIONS IN MM IF IN DOUBT, ASK - DO NOT SCALE</p>	<p>EUROPEAN SAFETY SYSTEMS LTD MARKET HOUSE LONDON W3 7QH WWW.ESS.COM</p>	<p>THIS DRAWING AND ANY INFORMATION OR DESCRIPTIVE MATTER THEREIN IS COMMUNICATED IN CONFIDENCE AND IS NOT TO BE DISCLOSED, COPIED OR USED FOR MANUFACTURING OR TENDERING PURPOSES WITHOUT THEIR WRITTEN CONSENT. © EUROPEAN SAFETY SYSTEMS LTD. AS PER LATEST DATE OF ISSUE SHOWN ABOVE</p>	<p>A3</p>	<p>SCALE SHEET NTS 2 OF 2</p>	<p>DRAWING NUMBER D218-06-201</p>
<p>TITLE AL100X, AL105NX & DL105X DC COMBINED SOUNDER & XENON WIRING DIAGRAMS</p>					

Linked Sounder & Beacon Activation (Default)

Config.: 1b

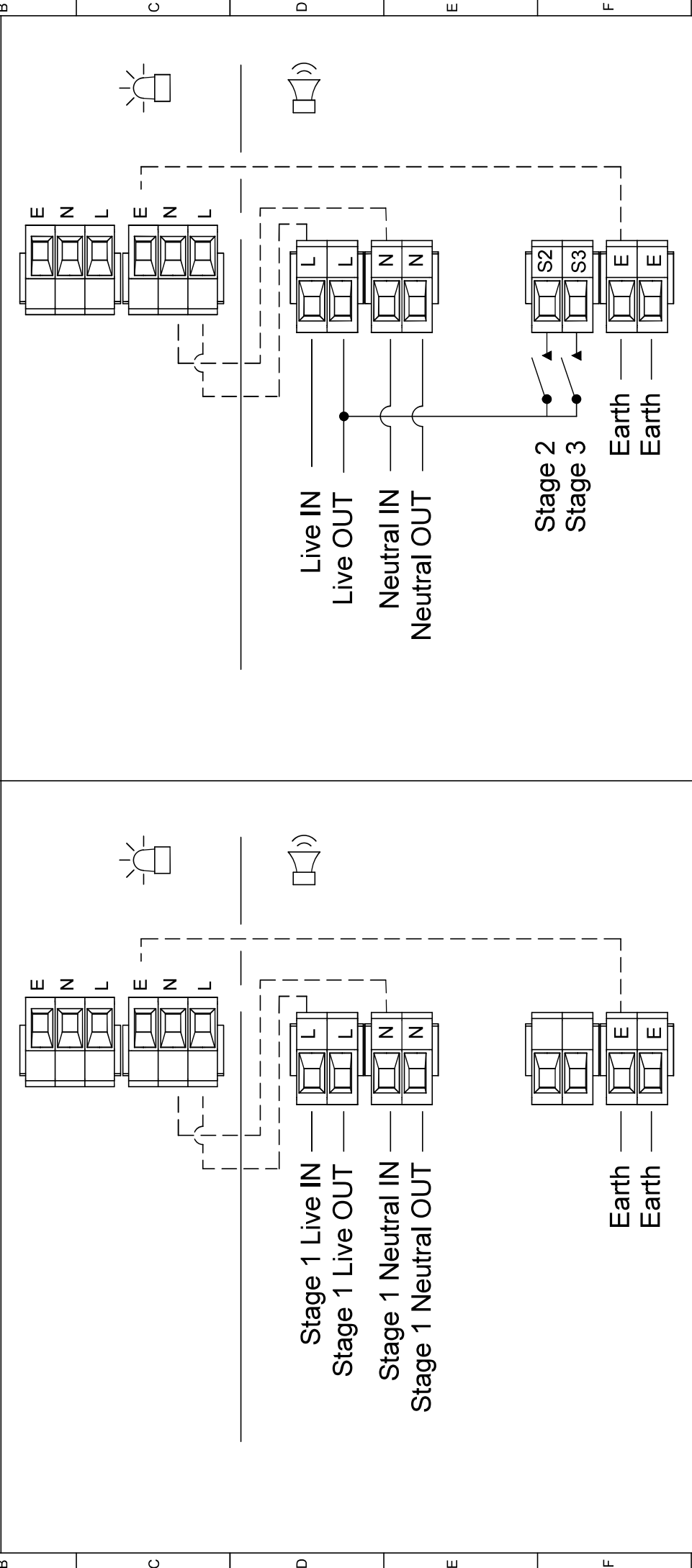

DRAWING TO BS8888:2000 GEOMETRIC TOLERANCES TO ISO1101:1983 LINEAR DIMENSIONAL TOLS ANGULAR DIMENSIONAL TOLS	DRAWN	DATE	SURFACE FINISH	WEIGHT (kg)
	R.S.RAIT	16/03/2021	MATERIAL	
STANDARDS ALERTALARM RANGE	CHECKED	DATE	ALTERNATIVE MATERIAL	
	B.ISARD	16/03/2021		
	APPROVED	DATE		
	R.N.POTTS	16/03/2021		

ALL DIMENSIONS IN MM
IF IN DOUBT, ASK -
DO NOT SCALE

TITLE AL100X, AL105NX & DL105X COMBINED
SOUNDER & XENON WIRING DIAGRAMS

SCALE SHEET NTS 1 OF 2 DRAWING NUMBER D218-06-205

© EUROPEAN SAFETY SYSTEMS LTD.
AS PER LATEST DATE OF ISSUE SHOWN ABOVE

EUROPEAN SAFETY SYSTEMS LTD
MARKET HOUSE
LONDON W3 7QH
WWW.ESS.COM

Independent Sounder & Beacon Activation (Remove Link Wires)

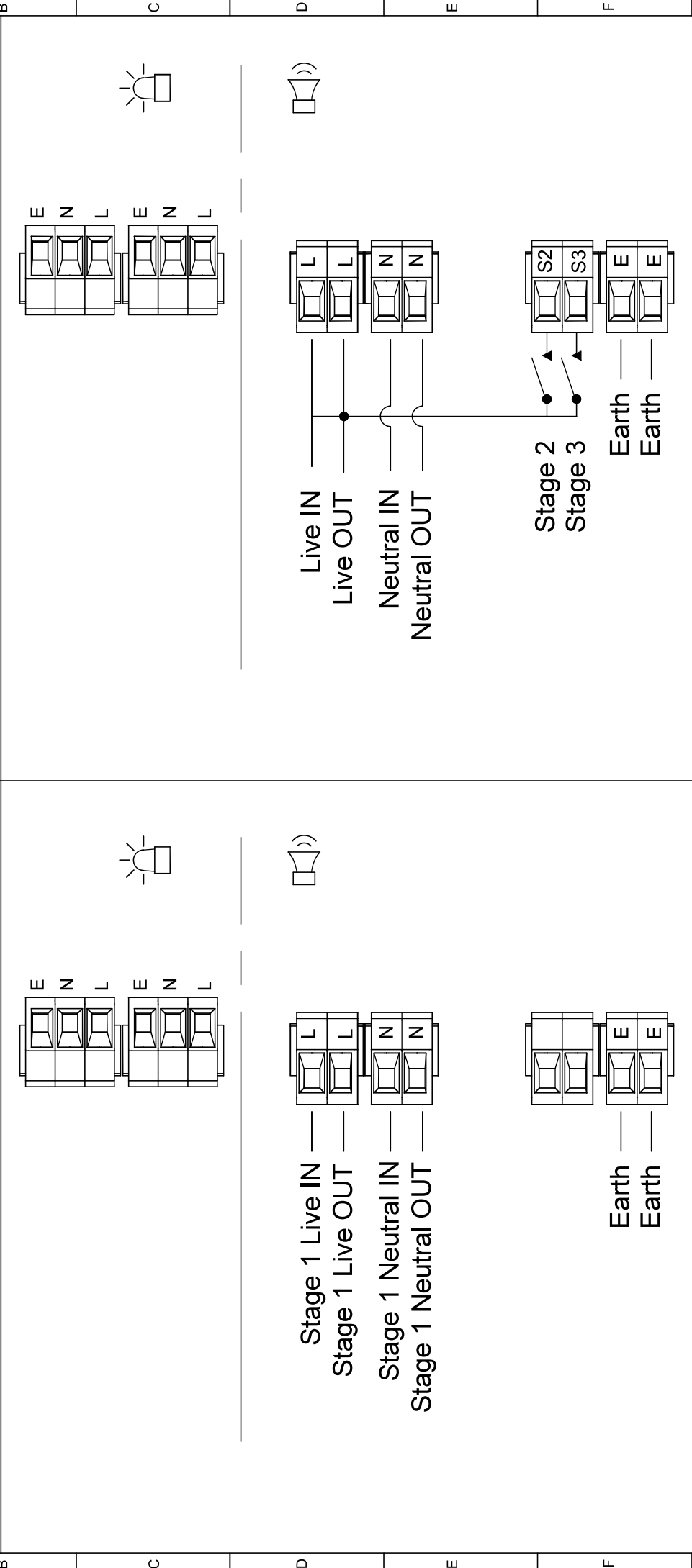

DRAWING TO BS8888:2000 GEOMETRIC TOLERANCES TO ISO1101:1983 LINEAR DIMENSIONAL TOLS ANGULAR DIMENSIONAL TOLS	DRAWN	DATE	SURFACE FINISH	WEIGHT (kg)
	R.S.RAIT	16/03/2021	MATERIAL	
STANDARDS ALERTALARM RANGE	CHECKED	DATE	ALTERNATIVE MATERIAL	
	B.ISARD	16/03/2021		
	APPROVED	DATE		
	R.N.POTTS	16/03/2021		

EUROPEAN SAFETY SYSTEMS LTD
 THE HOUSE
 MANES ROAD
 ACTON
 LONDON W3 7QH
 WWW.E2S.COM

THIS DRAWING AND ANY INFORMATION OR DESCRIPTIVE MATTER THEREIN IS COMMUNICATED IN CONFIDENCE AND IS THE PROPERTY OF EUROPEAN SAFETY SYSTEMS LTD. NEITHER THE WHOLE OR ANY EXTRACT MAY BE DISCLOSED, LOANED, COPIED OR USED FOR MANUFACTURING OR TENDERING PURPOSES WITHOUT THEIR WRITTEN CONSENT.

© EUROPEAN SAFETY SYSTEMS LTD.
 AS PER LATEST DATE OF ISSUE SHOWN ABOVE

ALL DIMENSIONS IN MM IF IN DOUBT, ASK - DO NOT SCALE		A3		
TITLE AL100X, AL105NX & DL105X COMBINED SOUNDER & XENON WIRING DIAGRAMS			SCALE	SHEET
			NTS	2 OF 2
			DRAWING NUMBER	D218-06-205