

- IP67/66 & Type 4/4X/13
- -40°C to +66°C (-40°F to +151°F)
- 3Kg (6.5lb)
- CE, UKCA, EAC & Russian Maritime Register approved

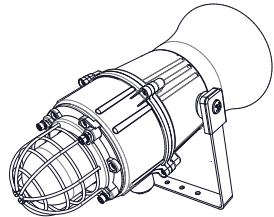

MC1X05F

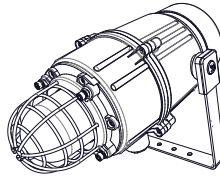

MC1X05R

Unit Type Code	Nominal Voltage	Voltage Range	Nominal Beacon Current	Nominal Sounder Current	Sound Pressure Level, dB(A)		
					Max*	Nom [†]	\bar{x} [‡]
MC1X05FDC024-T	24 Vdc	20-28 Vdc	300mA	224mA	116.6	113.7	112.7
MC1X05RDC024-T					113.6	110.7	109.7
MC1X05FAC115-T	115 Vac	115 Vac ±10% 50/60Hz	140mA	100mA	116.6	110.7	112.7
MC1X05RAC115-T					113.6	110.7	109.7
MC1X05FAC230-T	230 Vac	230 Vac ±10% 50/60Hz	55mA	64mA	116.6	113.7	112.7
MC1X05RAC230-T					113.6	110.7	109.7

*Max = Tone 4 / †Nominal = Tone 44 / ‡ \bar{x} = Average over 64 tones

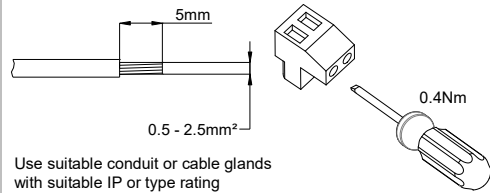

Attention: Installation must be carried out by an electrician in compliance with the latest codes and regulations.
 Attention: L'installation doit être effectuée par un électricien conformément aux derniers codes et réglementations.
 Achtung: Die Installation muss von einem Elektriker gemäß den neuesten Vorschriften und Bestimmungen durchgeführt werden.
 Attenzione: L'installazione deve essere eseguita da un elettricista in conformità con i codici e le normative più recenti.
 Atención: La instalación debe ser realizada por un electricista de acuerdo con los últimos códigos y regulaciones.
 Atenção: A instalação deve ser realizada por um electricista de acordo com os códigos e regulamentos mais recentes.
 ВНИМАНИЕ: установка должна выполняться электриком в соответствии с последними нормами и правилами.
 Attention: Disconnect from power source before installation or service to prevent electric shock
 Attention: Débranchez-le de la source d'alimentation avant l'installation ou l'entretien pour éviter tout choc électrique.
 Achtung: Vor Installation oder Wartung von der Stromquelle trennen, um einen Stromschlag zu vermeiden.
 Attenzione: scollegare dall'alimentazione prima dell'installazione o dell'assistenza per evitare scosse elettriche.
 Atención: desconéctelo de la fuente de alimentación antes de la instalación o el servicio para evitar descargas eléctricas.
 Atenção: Desconecte da fonte de alimentação antes da instalação ou serviço para evitar choque elétrico
 ВНИМАНИЕ: отключите от источника питания перед установкой или обслуживанием, чтобы предотвратить поражение электрическим током.

Relay / Telephone Inputs and Settings

Power Input Terminal for AC & DC Wiring

A suitable power supply (DC or AC voltage) cable should enter via one of the M20 entries and is to be connected to terminal TB1 (see Fig. 5 below). This provides the alarm horn sounder with continuous power.

DC Unit option: Connect the alarm horn sounder power input (+) to the (L/+) terminal (TB1) and power input (-) to the (N/-) at terminal (TB1).

AC Unit option: Connect the alarm horn sounder power input (L) to the (L/+) terminal (TB1) and power input (N) to (N/-) also an earth/ground input to the (E) terminal (TB1).

Please note: the earth/ground terminal of TB1 provides termination only for an earth/ground cable. Refer to section 8.3.

For AC and DC voltage wiring diagrams see document D250-06-001

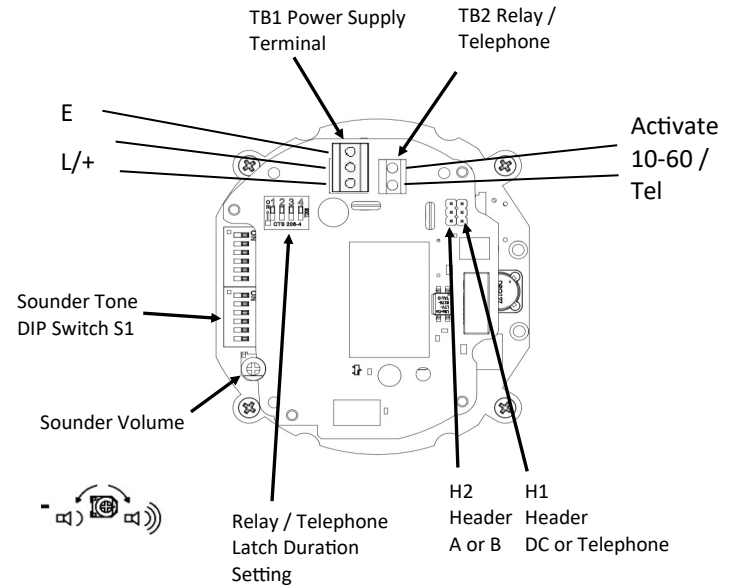

Prewired terminals from Sounder part to beacon

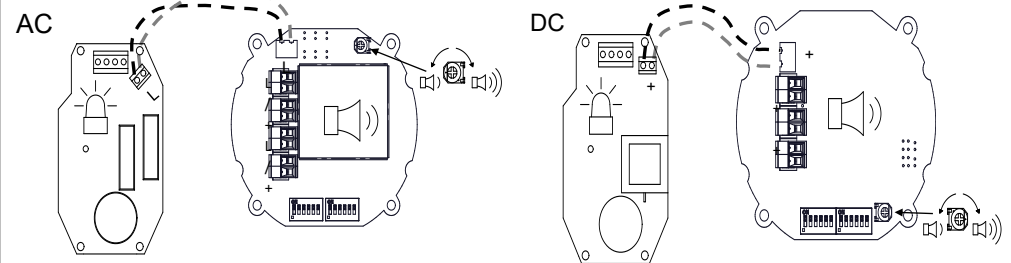

Activation, Relay / Telephone Wiring Inputs and Signal Type Header Setting (H1)

The H1 header selection configures the activation signal type.

Select H1 position marked AC for activation from an analogue telephone external ringer output REN1 (typically low current AC voltage around 90 to 150Vac)

Select H1 position marked DC for activation via a DC voltage input of 10 to 60Vdc e.g. a digital PBX external ringer output or a safety system relay output.

The activation input cables should utilise the second M20 cable entry and connect to terminal TB2.

Note: there is no polarity for this input.. Factory default H1 is set as AC for activation signal.

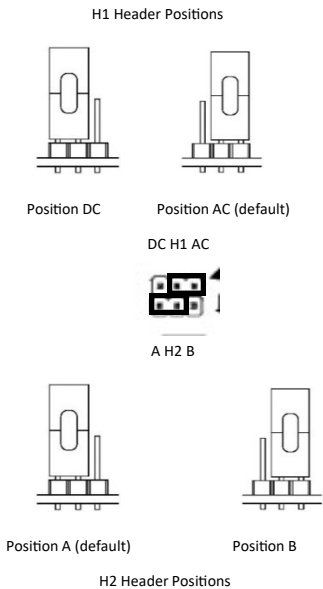

Fig 1 : Header H1 and H2 Positions

Unit Activation Mode - Pulsed or Latched, Header Setting (H2)

The H2 header selection configures the alarm horn sounder operation depending upon the type of activation signal.

Select H2 position option marked A for pulsed/cadence mode. The alarm horn sounder audible output will follow the telephone ring cadence or a pulsed relay input.

Select H2 position option marked B for latched mode. The alarm horn sounder audible output will start when an initiation signal is received and will not follow the telephone ringing cadence. See section on Unit Latch mode operation.

Option B is the factory default setting for combo units so the Beacon works effectively.

Unit Latch mode duration DIP switch S1 setting

The relay/telephone latch duration setting is only applicable when Header H2 is set to latched mode via header pin set to position option B. The alarm horn sounder is activated on the first telephone ring (or relay pulsed input) and any other subsequent inputs and will remain activated for the duration as set by DIP switch S1.

This feature is useful where some countries have short ringing cadence with long off cycle times and the customer requires the alarm sounder to operate for longer periods to better attract attention.

Where this feature becomes essential is for telephone/relay activated beacons to function correctly in these parameters.

Factory default for the relay/telephone latch duration switch setting is 0000. See table for DIP switch S1 delay timing.

Unit activation period (s) from start of activation signal.	DIP Switch S1 Setting (0000) = All off
1.5	0000
2.0	1000
2.5	0100
3.0	1100
3.5	0010
4.0	1010
4.5	0110
5.0	1110

Sounder Tone Selection DIP switch S1 setting

The D1x Alarm Horn Sounders have 64 different tones.

The alarm tone is selected by operation of the tone setting DIP switch S1 , see PCB layout on page 1.

Note DIP switch S2 and multistage selection is not possible with Relay / telephone activation unit.

Default = Switch 2	Default = Switch 1
Not used in this unit.	S1 – Tone 44
	1 1 0 1 0 1



(ON = 1, OFF = 0)

Figure 2: DIP switch configuration Figure 7: DIP switch configuration

The tone table (D221-95-001-IS) shows the switch positions for the 64 tones, dependent on the sounder Stage 1 DIP switch S1 setting.

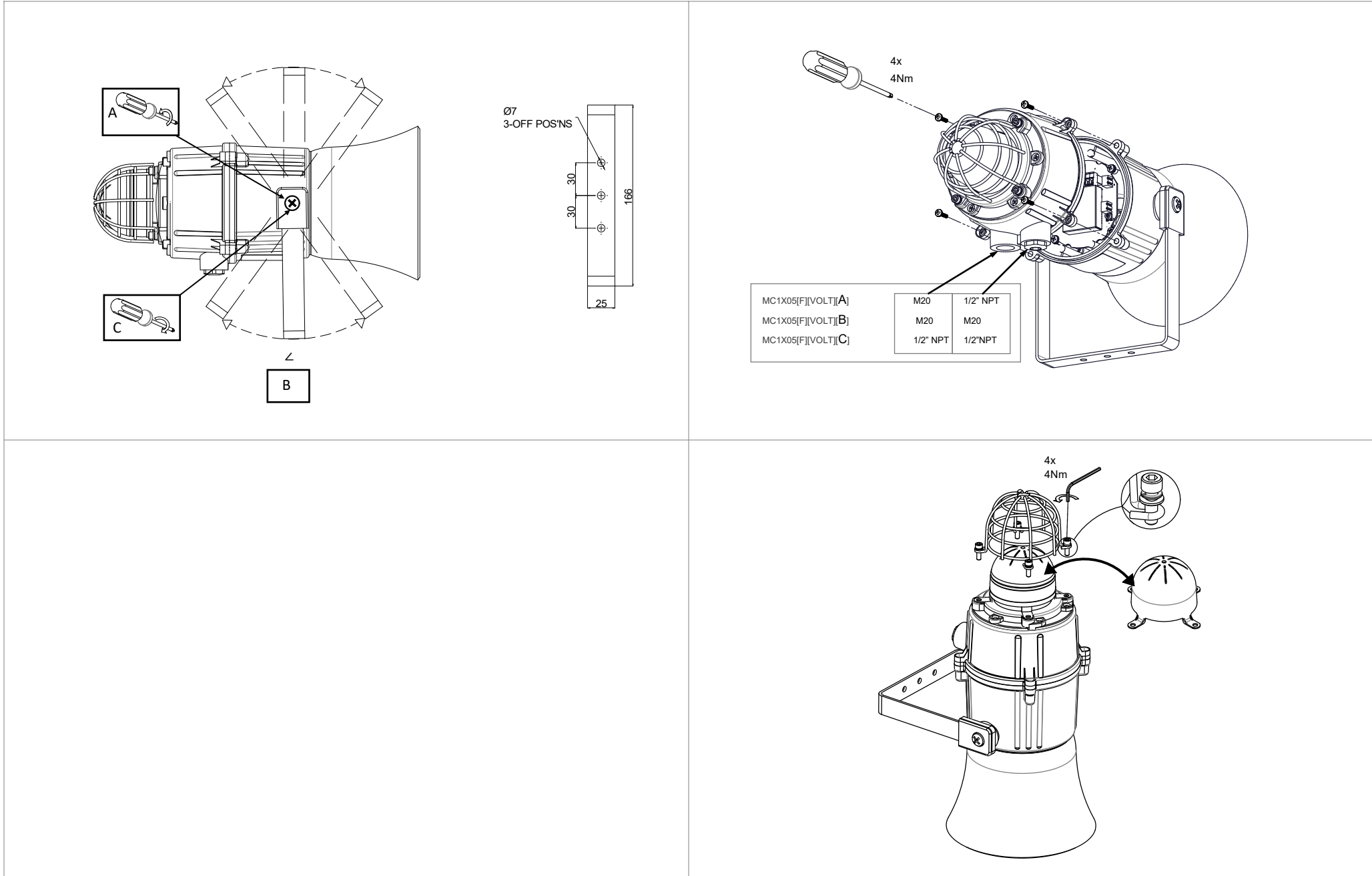

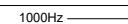
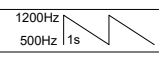
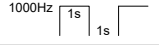
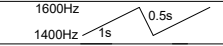
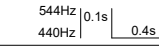
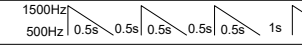
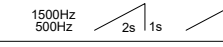
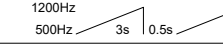
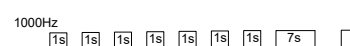
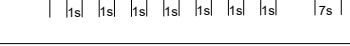
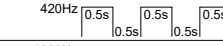
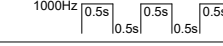
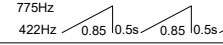
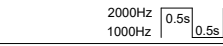
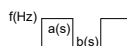
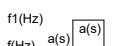
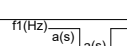
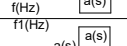
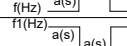
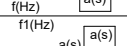
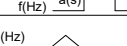
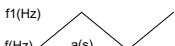
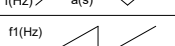
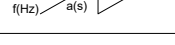
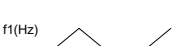
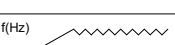
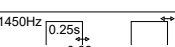
Stage 1 Set DIP SW 1 Tone No.	Tone Description	Tone Visual	Stage 1 & 2 DIP SW 1/2 Settings 1 2 3 4 5 6	Stage 3 Set DIP SW 1 (S3)	Stage 4 Set DIP SW 1 (S2 + S3)
1	1000Hz PFEER Toxic Gas		0 0 0 0 0 0	2	44
2	1200/500Hz @ 1Hz DIN /PFEER P.T.A.P.		1 0 0 0 0 0	3	44
3	1000Hz @ 0.5Hz(1s on, 1soff) PFEER Gen. Alarm		0 1 0 0 0 0	2	44
4	1.4KHz-1.6KHz 1s, 1.6KHz-1.4KHz 0.5s NF C 48-265		1 1 0 0 0 0	24	1
5	544Hz(100mS)/440Hz (400mS) NF S 32-001		0 0 1 0 0 0	19	1
6	1500/500Hz - (0.5s on , 0.5s off) x3 + 1s gap AS4428		1 0 1 0 0 0	44	1
7	500-1500Hz Sweeping 2 sec on 1 sec off AS4428		0 1 1 0 0 0	44	1
8	500/1200Hz @ 0.26Hz (3.3son, 0.5s off) Netherlands - NEN 2575		1 1 1 0 0 0	24	35
9	1000Hz (1s on, 1s off)x7 + (7s on, 1s off) IMO Code 1a		0 0 0 1 0 0	34	1
10	1000Hz (1s on, 1s off)x7 + (7s on, 1s off) IMO Code 1a		1 0 0 1 0 0	34	1
11	420Hz(0.5s on, 0.5s off)x3 + 1s gap ISO 8201 Temporal Pattern		0 1 0 1 0 0	1	8
12	1000Hz(0.5s on, 0.5s off)x3 + 1s gap ISO 8201 Temporal Pattern		1 1 0 1 0 0	1	8
13	422/775Hz - (0.85 on, 0.5 off) x3 + 1s gap NFPA - Temporal Coded		0 0 1 1 0 0	1	8
14	1000/2000Hz @ 1Hz Singapore		1 0 1 1 0 0	3	35
15	300Hz Continuous (f=300)		0 1 1 1 0 0	24	1
16	440Hz Continuous (f=440)		1 1 1 1 0 0	24	1
17	470Hz Continuous (f=470)		0 0 0 0 1 0	24	8
18	500Hz Continuous IMO code 2 (Low) (f=500)		1 0 0 0 1 0	24	8
19	554Hz Continuous (f=554)		0 1 0 0 1 0	24	8
20	660Hz Continuous (f=660)		1 1 0 0 1 0	24	35
21	800Hz IMO code 2 (High) (f=800)		0 0 1 0 1 0	24	35
22	1200Hz Continuous (f=1200)		1 0 1 0 1 0	24	35
23	2000Hz Continuous (f=2000)		0 1 1 0 1 0	3	35
24	2400Hz Continuous (f=2400)		1 1 1 0 1 0	20	35
25	440Hz @0.83Hz (50 cycles/minute) Intermittent (f=440, a=0.6, b=0.6)		0 0 0 1 1 0	44	8
26	470Hz @0.9Hz - 1.1s Intermittent (f=470, a=0.55, b=0.55)		1 0 0 1 1 0	44	8
27	470Hz @5Hz - (5 cycles/second) Intermittent (f=470, a=0.1, b=0.1)		0 1 0 1 1 0	44	8
28	544Hz @ 1.14Hz - 0.875s Intermittent (f=470, a=0.43, b=0.44)		1 1 0 1 1 0	24	8
29	655Hz @ 0.875Hz Intermittent (f=655, a=0.57, b=0.57)		0 0 1 1 1 0	24	8
30	660Hz @0.28Hz - 1.8sec on, 1.8sec off Intermittent (f=660, a=1.8, b=1.8)		1 0 1 1 1 0	24	8
31	660Hz @3.34Hz - 150mS on, 150mS off Intermittent (f=660, a=0.15, b=0.15)		0 1 1 1 1 0	24	8
32	745Hz @ 1Hz Intermittent (f=745, a=0.5, b=0.5)		1 1 1 1 1 0	24	8
33	800Hz - 0.25sec on, 1 sec off Intermittent (f=800, a=0.25, b=1)		0 0 0 0 0 1	24	8
34	800Hz @ 2Hz IMO code 3.a (High) Intermittent (f=800, a=0.25, b=0.25)		1 0 0 0 0 1	24	19
35	1000Hz @ 1Hz Intermittent (f=1000, a=0.5, b=0.5)		0 1 0 0 0 1	24	19
36	2400Hz @ 1Hz Intermittent (f=2400, a=0.5, b=0.5)		1 1 0 0 0 1	24	19
37	2900Hz @ 5Hz Intermittent (f=2900, a=0.1, b=0.1)		0 0 1 0 0 1	24	19
38	363/518Hz @ 1Hz Alternating (f=363, f1=518, a=0.1)		1 0 1 0 0 1	8	19
39	450/500Hz @ 2Hz Alternating (f=450, f1=500, a=0.25)		0 1 1 0 0 1	8	19
40	554/440Hz @ 1Hz Alternating (f=440, f1=554, a=0.5)		1 1 1 0 0 1	24	19
41	554/440Hz @ 0.625Hz Alternating (f=440, f1=554, a=0.8)		0 0 0 1 0 1	8	19
42	561/760Hz @0.83Hz (50 cycles/minute) Alternating (f=561, f1=760, a=0.6)		1 0 0 1 0 1	8	19
43	780/600Hz @ 0.96Hz Alternating (f=600, f1=780, a=0.52)		0 1 0 1 0 1	8	19
44	800/1000Hz @ 2Hz Alternating (f=800, f1=1000, a=0.25)		1 1 0 1 0 1	24	19
45	970/800Hz @ 2Hz Alternating (f=800, f1=970, a=0.25)		0 0 1 1 0 1	8	19
46	800/1000Hz @ 0.875Hz Alternating (f=800, f1=1000, a=0.57)		1 0 1 1 0 1	24	19
47	2400/2900Hz @ 2Hz Alternating (f=2400, f1=2900, a=0.25)		0 1 1 1 0 1	24	19
48	500/1200Hz @ 0.3Hz Sweeping (f=500, f1=1200, a=3.34)		1 1 1 1 0 1	24	12
49	560/1055Hz @ 0.18Hz Sweeping (f=560, f1=1055, a=5.47)		0 0 0 0 1 1	24	12
50	560/1055Hz @ 3.3Hz Sweeping (f=560, f1=1055, a=0.3)		1 0 0 0 1 1	24	12
51	600/1250Hz @ 0.125Hz Sweeping (f=600, f1=1250, a=8)		0 1 0 0 1 1	24	12
52	660/1200Hz @ 1Hz Sweeping (f=660, f1=1200, a=1)		1 1 0 0 1 1	24	12
53	800/1000Hz @ 1Hz Sweeping (f=800, f1=1000, a=1)		0 0 1 0 1 1	24	12
54	800/1000Hz @ 7Hz Sweeping (f=800, f1=1000, a=0.14)		1 0 1 0 1 1	24	12
55	800/1000Hz @ 50Hz Sweeping (f=800, f1=1000, a=0.02)		0 1 1 0 1 1	24	12
56	2400/2900Hz @ 7Hz Sweeping (f=2400, f1=2900, a=0.14)		1 1 1 0 1 1	24	12
57	2400/2900Hz @ 1Hz Sweeping (f=2400, f1=2900, a=1)		0 0 0 1 1 1	24	12
58	2400/2900Hz @ 50Hz Sweeping (f=2400, f1=2900, a=0.02)		1 0 0 1 1 1	24	12
59	2500/3000Hz @ 2Hz Sweeping (f=2500, f1=3000, a=0.5)		0 1 0 1 1 1	24	12
60	2500/3000Hz @ 7.7Hz Sweeping (f=2500, f1=3000, a=0.13)		1 1 0 1 1 1	24	12
61	800Hz Motor Siren (f=800, a=1.6)		0 0 1 1 1 1	24	12
62	1200Hz Motor Siren (f=1200, a=2)		1 0 1 1 1 1	24	12
63	2400Hz Motor Siren (f=2400, a=1.7)		0 1 1 1 1 1	24	12
64	Simulated Bell		1 1 1 1 1 1	21	12

1	2	3	4	5	6	7	8	9	10
							ISSUE	MOD No.	REASON - INITIAL - DATE
							A		INTRODUCTION RNP 31/03/2023

DC Power Input Configuration Config.: 1
 Used to Activate DC Sounder or Beacon Units
 With Telephone or Relay Signal
 Maintain DC Power to TB1
 Stage 1 only : Apply Signal to TB2 Singal Input Terminals

AC Power Input Configuration Config.: 2
 Used to Activate AC Sounder or Beacon Units
 With Telephone or Relay Signal
 Maintain AC Power to TB1
 Stage 1 only : Apply Signal to TB2 Singal Input Terminals

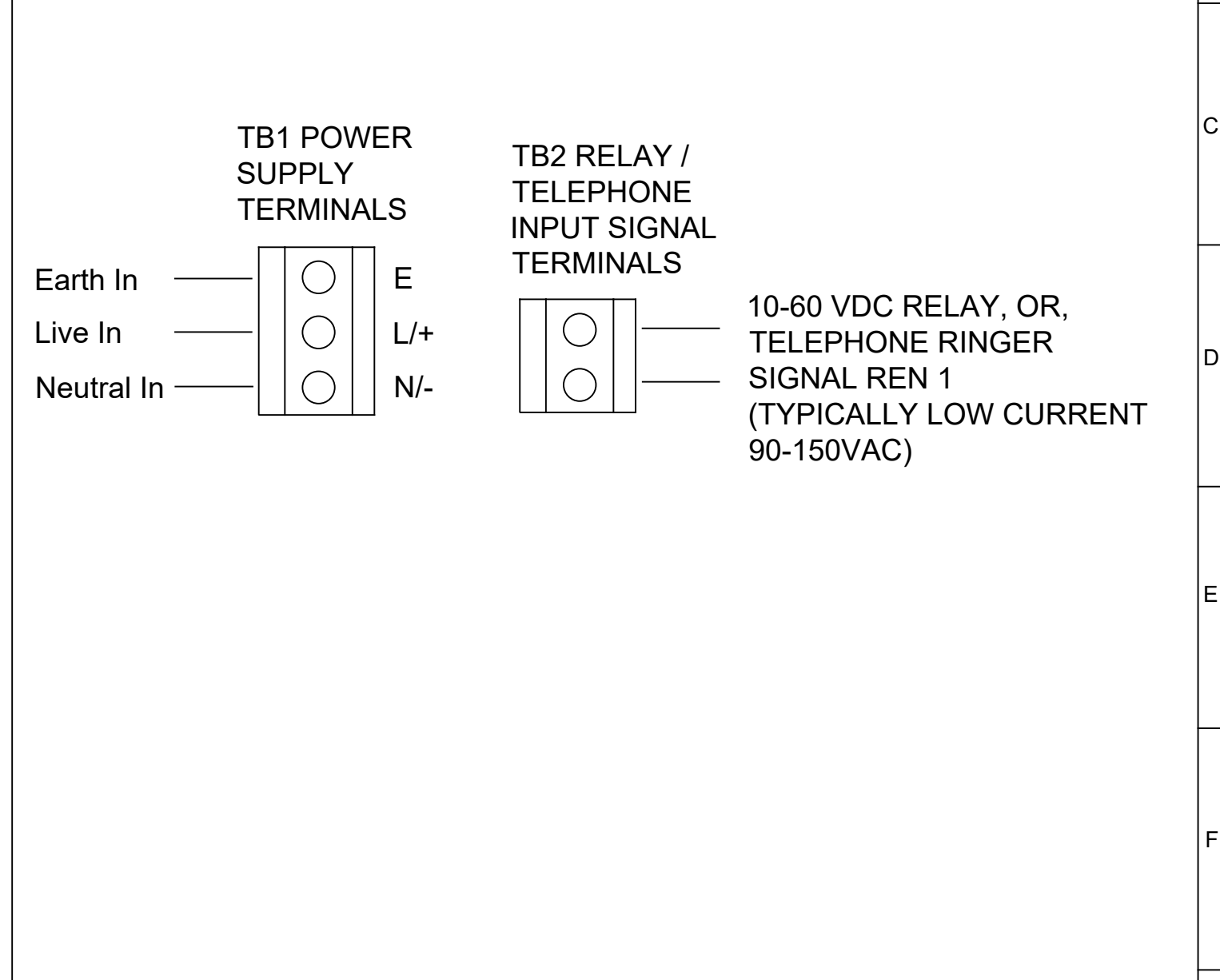
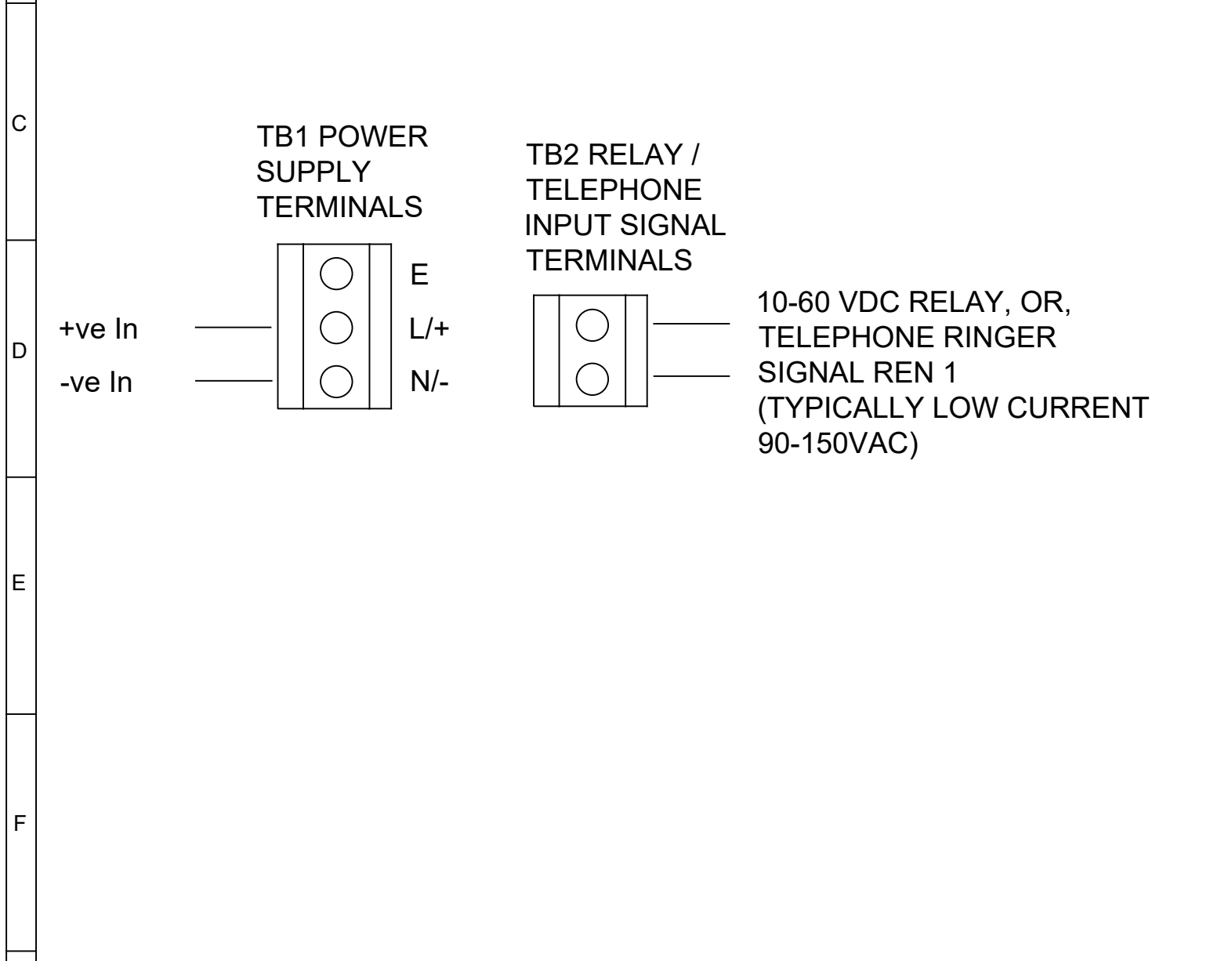

DRAWING TO BS8888:2000 GEOMETRIC TOLERANCES TO ISO1101:1983 LINEAR DIMENSIONAL TOLS ANGULAR DIMENSIONAL TOLS	DRAWN	DATE	SURFACE FINISH	WEIGHT (Kg)	THIS DRAWING AND ANY INFORMATION OR DESCRIPTIVE MATTER THEREIN IS COMMUNICATED IN CONFIDENCE AND IS THE COPYRIGHT PROPERTY OF EUROPEAN SAFETY SYSTEMS LTD. NEITHER THE WHOLE OR ANY EXTRACT MAY BE DISCLOSED, LOANED, COPIED OR USED FOR MANUFACTURING OR TENDERING PURPOSES WITHOUT THEIR WRITTEN CONSENT.	 EUROPEAN SAFETY SYSTEMS LTD IMPRESS HOUSE MANSELL ROAD ACTON LONDON W3 7QH WWW.E2S.COM	ALL DIMENSIONS IN MM		A3
	R.N.POTTS	16/03/2023					MATERIAL		
	CHECKED	DATE	ALTERNATIVE MATERIAL	TITLE TELEPHONE / RELAY ACTIVATION MODULE WIRING DIAGRAMS					
	R.S.RAIT	16/03/2023		SCALE			SHEET	DRAWING NUMBER	
STANDARDS	APPROVED	DATE							
ALERTALARM RANGE	R.N.POTTS	16/03/2023	NTS 1 OF 1 D250-06-001						