

Stage 1 Set DIP SW 1 Tone No.	Tone Description	Tone Visual	Stage 1 & 2 DIP SW 1/2 Settings 1 2 3 4 5 6	Stage 3 Set DIP SW 1 (S3)	Stage 4 Set DIP SW 1 (S2 + S3)
1	1000Hz PFEER Toxic Gas		0 0 0 0 0	2	44
2	1200/500Hz @ 1Hz DIN /PFEER P.T.A.P.		1 0 0 0 0	3	44
3	1000Hz @ 0.5Hz(1s on, 1soff) PFEER Gen. Alarm		0 1 0 0 0 0	2	44
4	1.4KHz-1.6KHz 1s, 1.6KHz-1.4KHz 0.5s NF C 48-265		1 1 0 0 0 0	24	1
5	544Hz(100mS)/440Hz (400mS) NF S 32-001		0 0 1 0 0 0	19	1
6	1500/500Hz - (0.5s on , 0.5s off) x3 + 1s gap AS4428		1 0 1 0 0 0	44	1
7	500-1500Hz Sweeping 2 sec on 1 sec off AS4428		0 1 1 0 0 0	44	1
8	500/1200Hz @ 0.26Hz (3.3son, 0.5s off) Netherlands - NEN 2575		1 1 1 0 0 0	24	35
9	1000Hz (1s on, 1s off)x7 + (7s on, 1s off) IMO Code 1a		0 0 0 1 0 0	34	1
10	1000Hz (1s on, 1s off)x7 + (7s on, 1s off) IMO Code 1a		1 0 0 1 0 0	34	1
11	420Hz(0.5s on, 0.5s off)x3 + 1s gap ISO 8201 Temporal Pattern		0 1 0 1 0 0	1	8
12	1000Hz(0.5s on, 0.5s off)x3 + 1s gap ISO 8201 Temporal Pattern		1 1 0 1 0 0	1	8
13	422/775Hz - (0.85 on, 0.5 off) x3 + 1s gap NFPA - Temporal Coded		0 0 1 1 0 0	1	8
14	1000/2000Hz @ 1Hz Singapore		1 0 1 1 0 0	3	35
15	300Hz Continuous (f=300)		0 1 1 1 0 0	24	35
16	440Hz Continuous (f=440)		1 1 1 1 0 0	24	35
17	470Hz Continuous (f=470)		0 0 0 0 1 0	24	35
18	500Hz Continuous IMO code 2 (Low) (f=500)		1 0 0 0 1 0	24	35
19	554Hz Continuous (f=554)		0 1 0 0 1 0	24	35
20	660Hz Continuous (f=660)		1 1 0 0 1 0	24	35
21	800Hz IMO code 2 (High) (f=800)		0 0 1 0 1 0	24	35
22	1200Hz Continuous (f=1200)		1 0 1 0 1 0	24	35
23	2000Hz Continuous (f=2000)		0 1 1 0 1 0	3	35
24	2400Hz Continuous (f=2400)		1 1 1 0 1 0	20	35
25	440Hz @0.83Hz (50 cycles/minute) Intermittent (f=440, a=0.6, b=0.6)		0 0 0 1 1 0	44	8
26	470Hz @0.9Hz - 1.1s Intermittent (f=470, a=0.55, b=0.55)		1 0 0 1 1 0	44	8
27	470Hz @5Hz - (5 cycles/second) Intermittent (f=470, a=0.1, b=0.1)		0 1 0 1 1 0	44	8
28	544Hz @ 1.14Hz - 0.875s Intermittent (f=470, a=0.43, b=0.44)		1 1 0 1 1 0	24	8
29	655Hz @ 0.875Hz Intermittent (f=655, a=0.57, b=0.57)		0 0 1 1 1 0	44	8
30	660Hz @0.28Hz - 1.8sec on, 1.8sec off Intermittent (f=660, a=1.8, b=1.8)		1 0 1 1 1 0	24	8
31	660Hz @3.34Hz - 150mS on, 150mS off Intermittent (f=660, a=0.15, b=0.15)		0 1 1 1 1 0	24	8
32	745Hz @ 1Hz Intermittent (f=745, a=0.5, b=0.5)		1 1 1 1 1 0	24	8
33	800Hz - 0.25sec on, 1 sec off Intermittent (f=800, a=0.25, b=1)		0 0 0 0 0 1	24	8
34	800Hz @ 2Hz IMO code 3.a (High) Intermittent (f=800, a=0.25, b=0.25)		1 0 0 0 0 1	24	8
35	1000Hz @ 1Hz Intermittent (f=1000, a=0.5, b=0.5)		0 1 0 0 0 1	24	8
36	2400Hz @ 1Hz Intermittent (f=2400, a=0.5, b=0.5)		1 1 0 0 0 1	24	8
37	2900Hz @ 5Hz Intermittent (f=2900, a=0.1, b=0.1)		0 0 1 0 0 1	24	8
38	363/518Hz @ 1Hz Alternating (f=363, f1=518, a=0.1)		1 0 1 0 0 1	8	19
39	450/500Hz @ 2Hz Alternating (f=450, f1=500, a=0.25)		0 1 1 0 0 1	8	19
40	554/440Hz @ 1Hz Alternating (f=440, f1=554, a=0.5)		1 1 1 0 0 1	24	19
41	554/440Hz @ 0.625Hz Alternating (f=440, f1=554, a=0.8)		0 0 0 1 0 1	8	19
42	561/760Hz @0.83Hz (50 cycles/minute) Alternating (f=561, f1=760, a=0.6)		1 0 0 1 0 1	8	19
43	780/600Hz @ 0.96Hz Alternating (f=600, f1=780, a=0.52)		0 1 0 1 0 1	8	19
44	800/1000Hz @ 2Hz Alternating (f=800, f1=1000, a=0.25)		1 1 0 1 0 1	24	19
45	970/800Hz @ 2Hz Alternating (f=800, f1=970, a=0.25)		0 0 1 1 0 1	8	19
46	800/1000Hz @ 0.875Hz Alternating (f=800, f1=1000, a=0.57)		1 0 1 1 0 1	24	19
47	2400/2900Hz @ 2Hz Alternating (f=2400, f1=2900, a=0.25)		0 1 1 1 0 1	24	19
48	500/1200Hz @ 0.3Hz Sweeping (f=500, f1=1200, a=3.34)		1 1 1 1 0 1	24	12
49	560/1055Hz @ 0.18Hz Sweeping (f=560, f1=1055, a=5.47)		0 0 0 0 1 1	24	12
50	560/1055Hz @ 3.3Hz Sweeping (f=560, f1=1055, a=0.3)		1 0 0 0 1 1	24	12
51	600/1250Hz @ 0.125Hz Sweeping (f=600, f1=1250, a=8)		0 1 0 0 1 1	24	12
52	660/1200Hz @ 1Hz Sweeping (f=660, f1=1200, a=1)		1 1 0 0 1 1	24	12
53	800/1000Hz @ 1Hz Sweeping (f=800, f1=1000, a=1)		0 0 1 0 1 1	24	12
54	800/1000Hz @ 7Hz Sweeping (f=800, f1=1000, a=0.14)		1 0 1 0 1 1	24	12
55	800/1000Hz @ 50Hz Sweeping (f=800, f1=1000, a=0.02)		0 1 1 0 1 1	24	12
56	2400/2900Hz @ 7Hz Sweeping (f=2400, f1=2900, a=0.14)		1 1 1 0 1 1	24	12
57	2400/2900Hz @ 1Hz Sweeping (f=2400, f1=2900, a=1)		0 0 0 1 1 1	24	12
58	2400/2900Hz @ 50Hz Sweeping (f=2400, f1=2900, a=0.02)		1 0 0 1 1 1	24	12
59	2500/3000Hz @ 2Hz Sweeping (f=2500, f1=3000, a=0.5)		0 1 0 1 1 1	24	12
60	2500/3000Hz @ 7.7Hz Sweeping (f=2500, f1=3000, a=0.13)		1 1 0 1 1 1	24	12
61	800Hz Motor Siren (f=800, a=1.6)		0 0 1 1 1 1	24	12
62	1200Hz Motor Siren (f=1200, a=2)		1 0 1 1 1 1	24	12
63	2400Hz Motor Siren (f=2400, a=1.7)		0 1 1 1 1 1	24	12
64	Simulated Bell		1 1 1 1 1 1	21	12

1	2	3	4	5	6	7	8	9	10
							ISSUE	MOD No.	REASON - INITIAL - DATE
							B		Configuration titles amended RSR - 19/05/2021
							C	ACN0153	OPTIONS Y & V MONITORING DETAILS RSR - 06/06/2024

— — WIRING LINKING BEACON & SOUNDER
FACTORY FITTED

OPTIONAL LINE MONITORING RESISTOR, CUSTOMER SUPPLIED,
RECOMMENDED MINIMUM VALUES:
14V MAX SYSTEM = 120Ω MIN, 2W MIN OR 1KΩ MIN, 0.5W MIN
28V MAX SYSTEM = 470Ω MIN, 2W MIN OR 2.4KΩ MIN, 0.5W MIN

Linked Sounder & Beacon Activation (Default)

Single Stage Configuration	Config.: 1a	Two Stage Configuration	Config.: 1b	Three/Four Stage Configuration	Config.: 1c
Line Monitoring Set to positive switching (default)		Common Negative Set to positive switching (default)		Common Negative Set to positive switching (default)	
Stage 1: Apply Power to Stage 1 +ve & Stage 1 -ve		Stage 1: Apply Power to Stage 1 +ve & Common -ve Stage 2: Apply Power to Stage 2 +ve & Common -ve		Stage 1: Apply Power to Stage 1 +ve & Common -ve Stage 2: Apply Power to Stage 2 +ve & Common -ve Stage 3: Apply Power to Stage 3 +ve & Common -ve Stage 4: Apply Power to Stage 2 +ve, Stage 3 +ve & Common -ve	

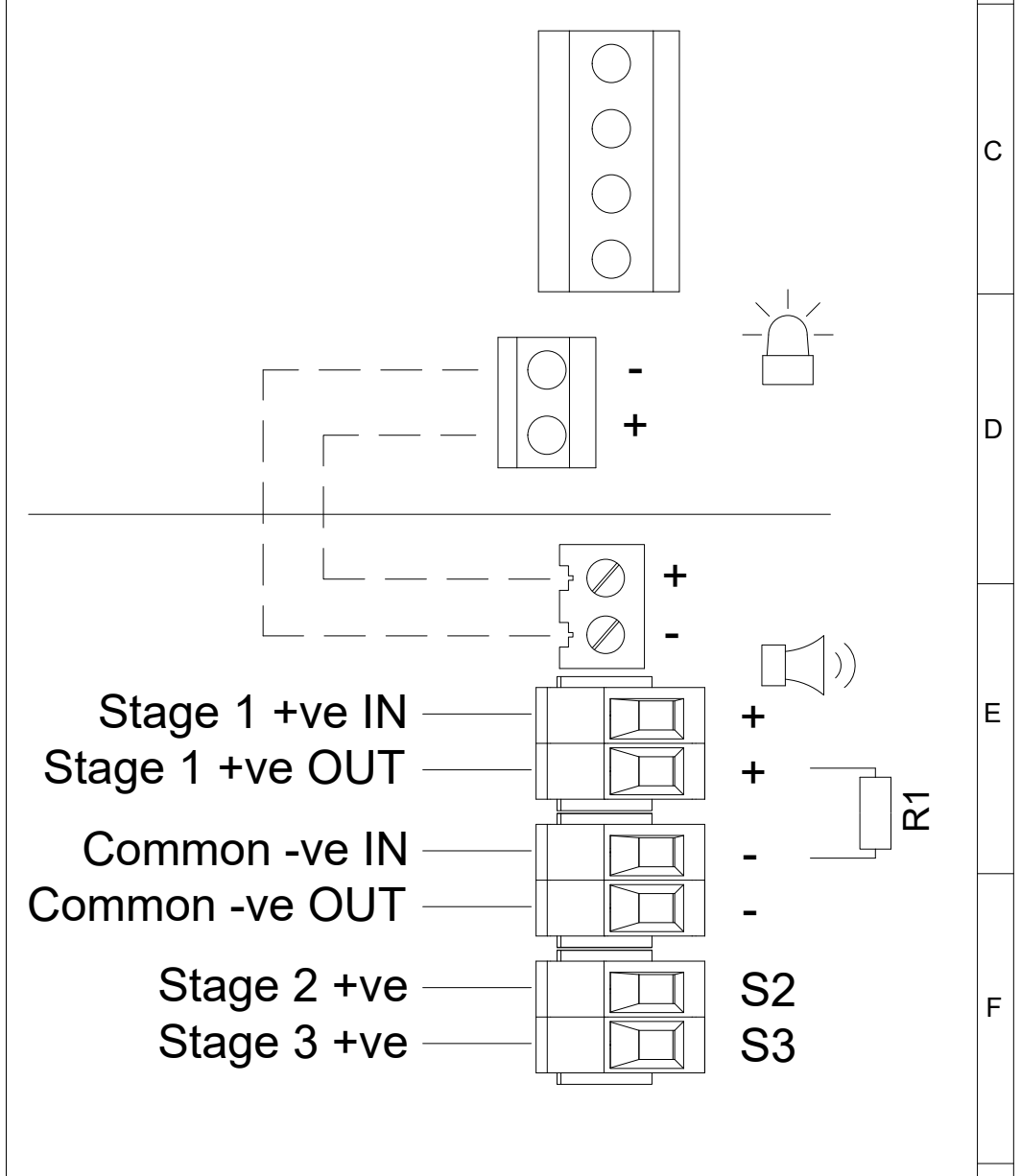
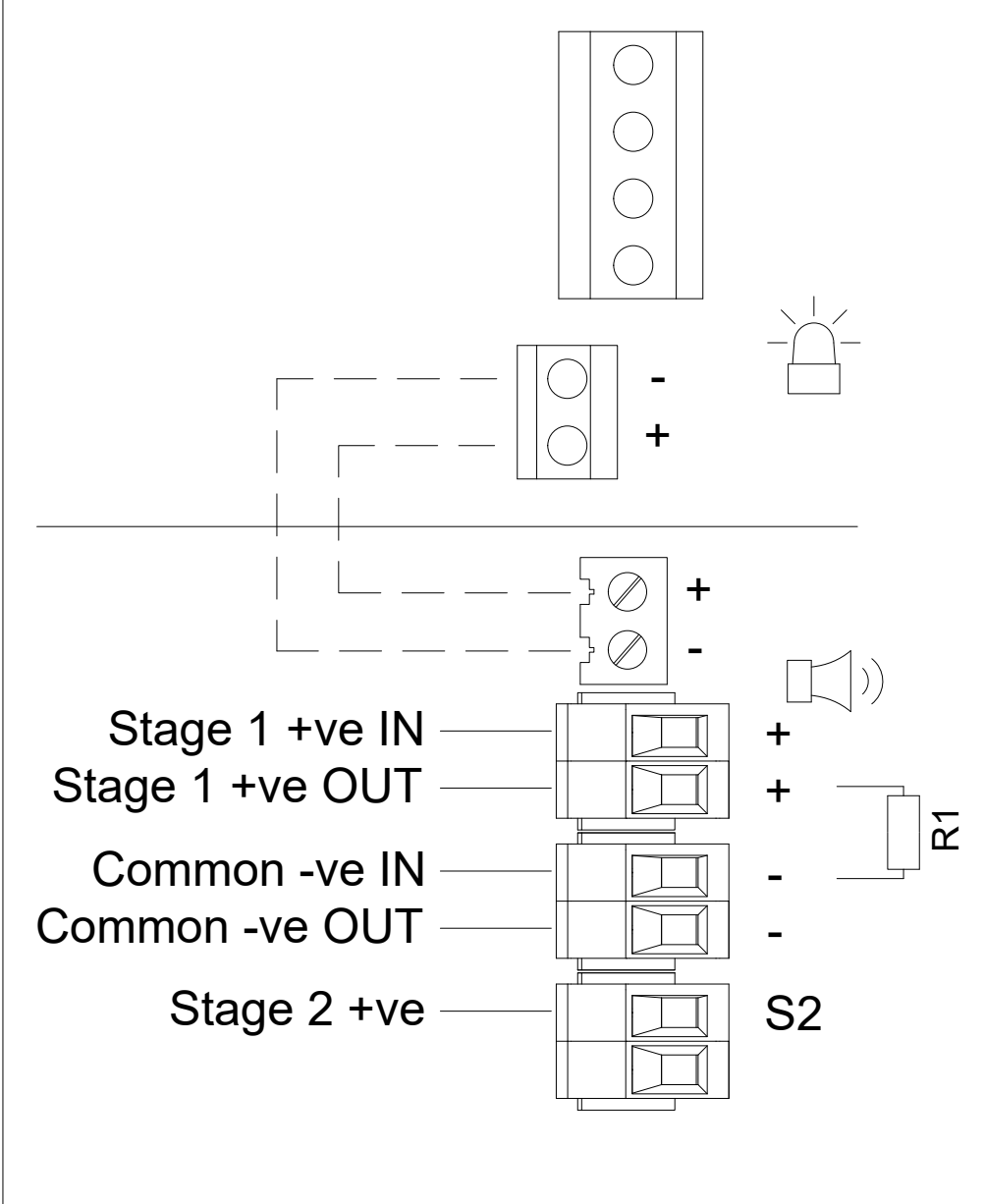
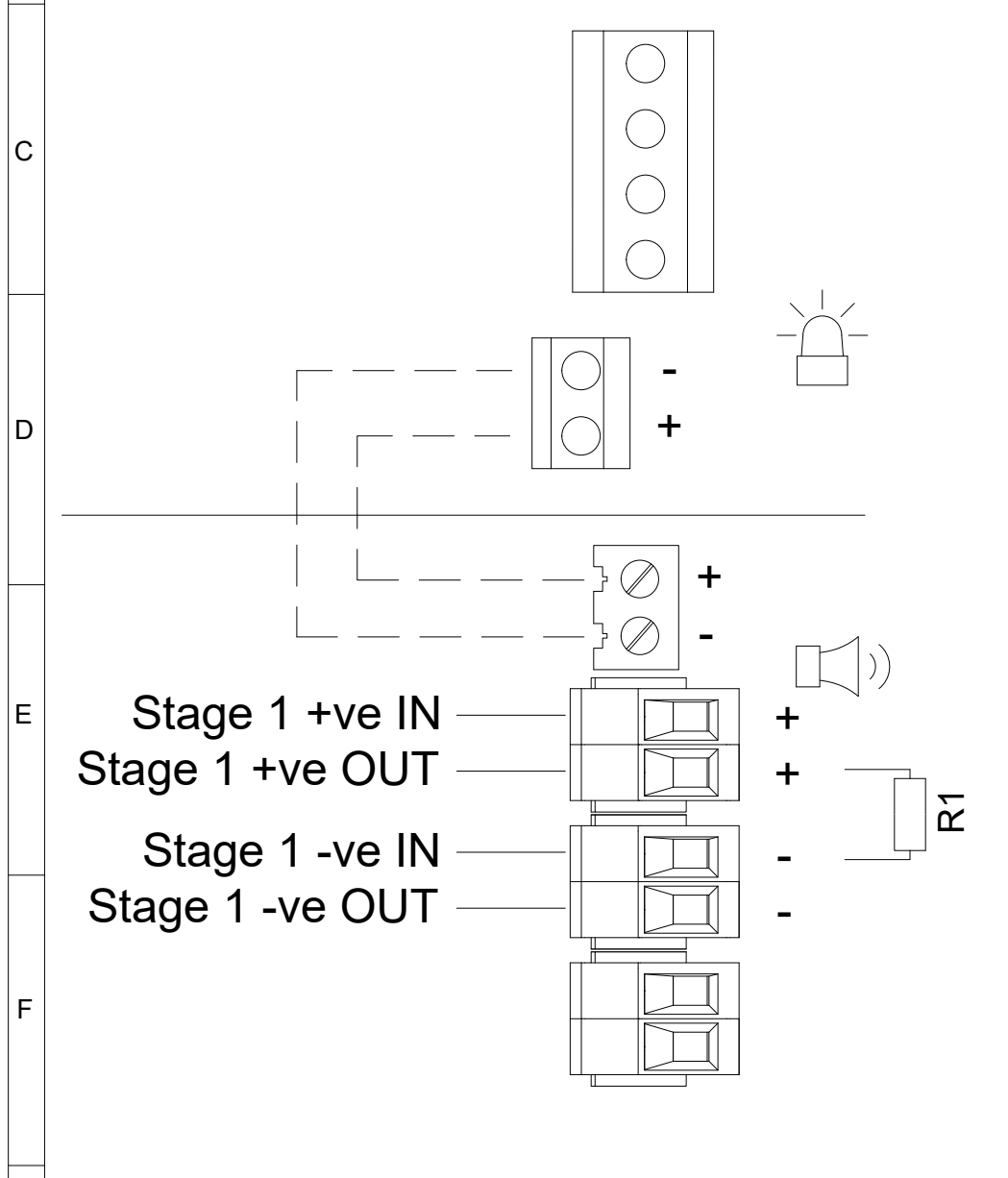

G	DRAWING TO BS8888:2000 GEOMETRIC TOLERANCES TO ISO1101:1983 LINEAR DIMENSIONAL TOLS ANGULAR DIMENSIONAL TOLS	DRAWN R.S.RAIT	DATE 05/03/2021	SURFACE FINISH	WEIGHT (Kg)	<p>THIS DRAWING AND ANY INFORMATION OR DESCRIPTIVE MATTER THEREIN IS COMMUNICATED IN CONFIDENCE AND IS THE COPYRIGHT PROPERTY OF EUROPEAN SAFETY SYSTEMS LTD. NEITHER THE WHOLE OR ANY EXTRACT MAY BE DISCLOSED, LOANED, COPIED OR USED FOR MANUFACTURING OR TENDERING PURPOSES WITHOUT THEIR WRITTEN CONSENT.</p> <p>© EUROPEAN SAFETY SYSTEMS LTD. AS PER LATEST DATE OF ISSUE SHOWN ABOVE</p>	<p>EUROPEAN SAFETY SYSTEMS LTD IMPRESS HOUSE MANSELL ROAD ACTON LONDON W3 7QH WWW.E2S.COM</p>	ALL DIMENSIONS IN MM IF IN DOUBT, ASK - DO NOT SCALE		A3
	STANDARDS M RANGE	CHECKED B.ISARD	DATE 05/03/2021	MATERIAL	TITLE MC1X05 DC COMBINED SOUNDER XENON BEACON WIRING DIAGRAMS					
		APPROVED R.N.POTTS	DATE 05/03/2021	ALTERNATIVE MATERIAL	SCALE NTS			SHEET 1 OF 6	DRAWING NUMBER D207-06-501	

1	2	3	4	5	6	7	8	9	10
							ISSUE	MOD No.	REASON - INITIAL - DATE
							B		Configuration titles amended RSR - 19/05/2021
							C	ACN0153	OPTIONS Y & V MONITORING DETAILS RSR - 06/06/2024

WIRING LINKING BEACON & SOUNDER
FACTORY FITTED

OPTIONAL LINE MONITORING RESISTOR, CUSTOMER SUPPLIED,
RECOMMENDED MINIMUM VALUES:
14V MAX SYSTEM = 120Ω MIN, 2W MIN OR 1KΩ MIN, 0.5W MIN
28V MAX SYSTEM = 470Ω MIN, 2W MIN OR 2.4KΩ MIN, 0.5W MIN

SWITCHES FOR STAGE OPERATION
CUSTOMER SUPPLIED

Linked Sounder & Beacon Activation (Default)

Three/Four Stages. Voltage Free 2nd, 3rd & 4th Stage Activation Configuration				Config.: 2	Two Stage Configuration				Config.: 3
Common Positive Customer Set H1 & H2 to Negative Switching (See Below)				Independent Stage Input Reverse Polarity Stage Monitoring					
Stage 1: Apply Power to Common +ve & Stage 1 -ve Stage 2: Apply Power to Common +ve & Stage 1 -ve & connect Stage 2 -ve to Stage 1 -ve Stage 3: Apply Power to Common +ve & Stage 1 -ve & connect Stage 3 -ve to Stage 1 -ve Stage 4: Apply Power to Common +ve & Stage 1 -ve & connect Stage 2 -ve & Stage 3 -ve to Stage 1 -ve				Stage 1: Apply Power to Stage 1 +ve & Stage 1 -ve Stage 2: Apply Power to Stage 1 +ve & Stage 1 -ve & connect Stage 2 -ve to Stage 1 -ve					

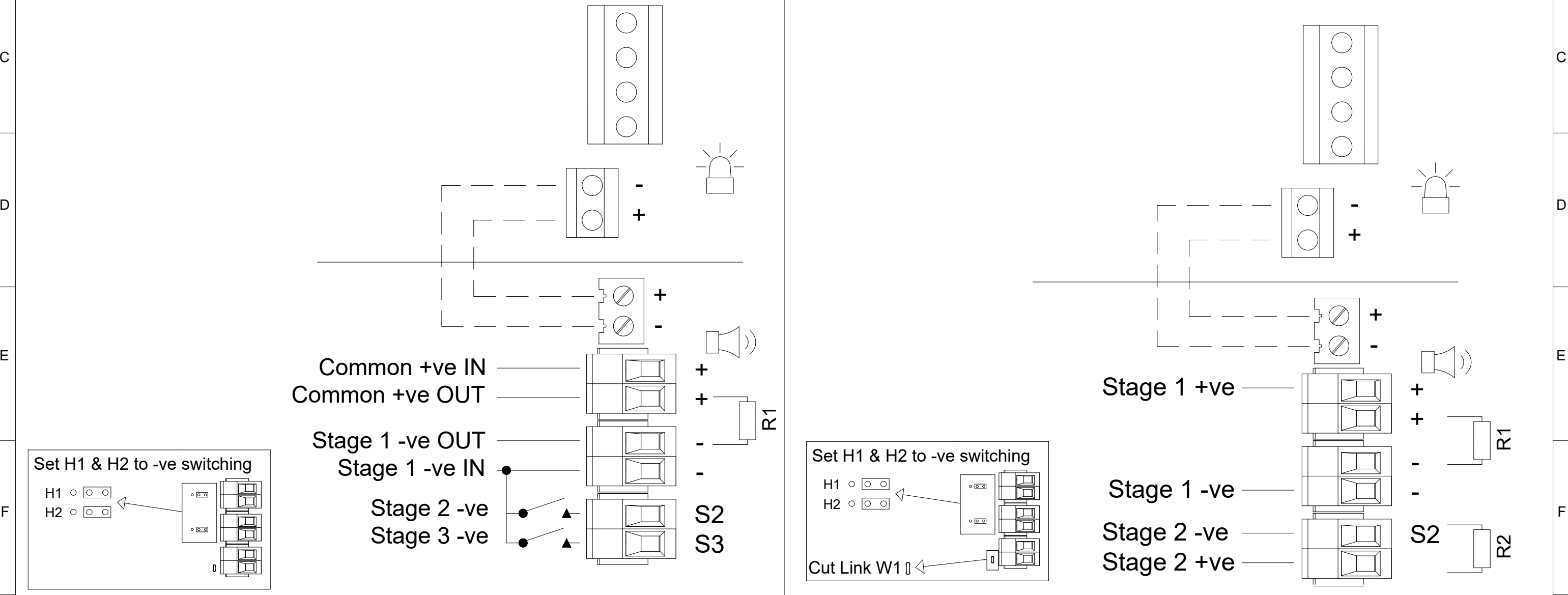

DRAWING TO BS8888:2000 GEOMETRIC TOLERANCES TO ISO1101:1983 LINEAR DIMENSIONAL TOLS ANGULAR DIMENSIONAL TOLS	DRAWN	DATE	SURFACE FINISH	WEIGHT (Kg)	THIS DRAWING AND ANY INFORMATION OR DESCRIPTIVE MATTER THEREIN IS COMMUNICATED IN CONFIDENCE AND IS THE COPYRIGHT PROPERTY OF EUROPEAN SAFETY SYSTEMS LTD. NEITHER THE WHOLE OR ANY EXTRACT MAY BE DISCLOSED, LOANED, COPIED OR USED FOR MANUFACTURING OR TENDERING PURPOSES WITHOUT THEIR WRITTEN CONSENT.	 EUROPEAN SAFETY SYSTEMS LTD IMPRESS HOUSE MANSELL ROAD ACTON LONDON W3 7QH WWW.E2S.COM	ALL DIMENSIONS IN MM		 A3		
	R.S.RAIT	05/03/2021					IF IN DOUBT, ASK - DO NOT SCALE			TITLE MC1X05 DC COMBINED SOUNDER XENON BEACON WIRING DIAGRAMS	
	CHECKED	DATE					EUROPEAN SAFETY SYSTEMS LTD. AS PER LATEST DATE OF ISSUE SHOWN ABOVE		SCALE	SHEET	DRAWING NUMBER
	B.ISARD	05/03/2021						NTS	2 OF 6	D207-06-501	
STANDARDS	APPROVED	DATE	ALTERNATIVE MATERIAL								
M RANGE	R.N.POTTS	05/03/2021									

1	2	3	4	5	6	7	8	9	10
							ISSUE	MOD No.	REASON - INITIAL - DATE
							B		Configuration titles amended RSR - 19/05/2021
							C	ACN0153	OPTIONS Y & V MONITORING DETAILS RSR - 06/06/2024

— — WIRING LINKING BEACON & SOUNDER
FACTORY FITTED

OPTIONAL LINE MONITORING RESISTOR, CUSTOMER SUPPLIED,
RECOMMENDED MINIMUM VALUES:
14V MAX SYSTEM = 120Ω MIN, 2W MIN OR 1KΩ MIN, 0.5W MIN
28V MAX SYSTEM = 470Ω MIN, 2W MIN OR 2.4KΩ MIN, 0.5W MIN

SWITCHES FOR STAGE OPERATION
CUSTOMER SUPPLIED

Linked Sounder & Beacon Activation (Default)

Two Stage Configuration Config.: 4

Independent power input for alarm stage activation.
Line monitoring available for Stage 1 & 2 alarm stage.
Line monitoring requires common negative between each power input.
Line monitoring maximum voltage: 4Vdc.

Not to be used for reverse polarity line monitoring.
Stage 1: Apply Power to Stage 1 +ve & Stage 1 -ve
Stage 2: Apply Power to Stage 2 +ve & Stage 2 -ve

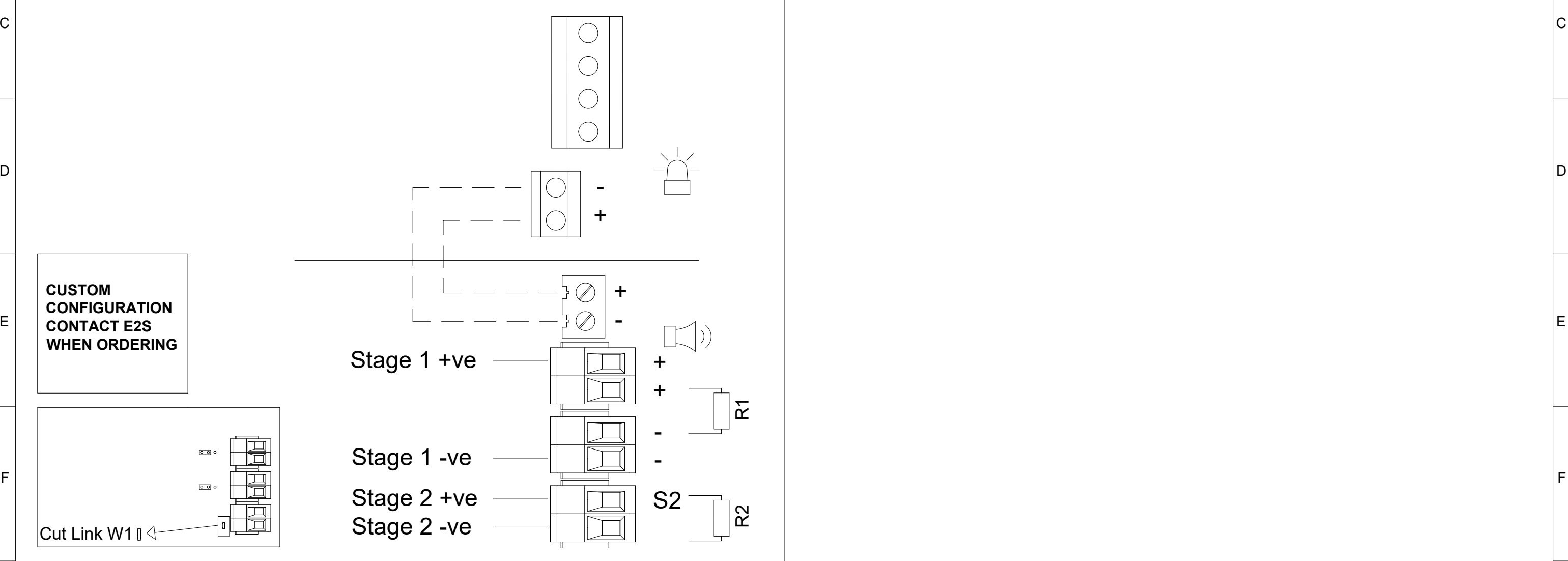

G	DRAWING TO BS8888:2000 GEOMETRIC TOLERANCES TO ISO1101:1983 LINEAR DIMENSIONAL TOLS ANGULAR DIMENSIONAL TOLS	DRAWN R.S.RAIT	DATE 05/03/2021	SURFACE FINISH	WEIGHT (Kg)	<p>THIS DRAWING AND ANY INFORMATION OR DESCRIPTIVE MATTER THEREIN IS COMMUNICATED IN CONFIDENCE AND IS THE COPYRIGHT PROPERTY OF EUROPEAN SAFETY SYSTEMS LTD. NEITHER THE WHOLE OR ANY EXTRACT MAY BE DISCLOSED, LOANED, COPIED OR USED FOR MANUFACTURING OR TENDERING PURPOSES WITHOUT THEIR WRITTEN CONSENT.</p> <p>© EUROPEAN SAFETY SYSTEMS LTD. AS PER LATEST DATE OF ISSUE SHOWN ABOVE</p>	<p>EUROPEAN SAFETY SYSTEMS LTD IMPRESS HOUSE MANSELL ROAD ACTON LONDON W3 7QH WWW.E2S.COM</p>	ALL DIMENSIONS IN MM IF IN DOUBT, ASK - DO NOT SCALE		A3
	STANDARDS M RANGE	CHECKED B.ISARD	DATE 05/03/2021	MATERIAL	TITLE MC1X05 DC COMBINED SOUNDER XENON BEACON WIRING DIAGRAMS					
		APPROVED R.N.POTTS	DATE 05/03/2021	ALTERNATIVE MATERIAL	SCALE NTS			SHEET 3 OF 6	DRAWING NUMBER D207-06-501	

1	2	3	4	5	6	7	8	9	10
							ISSUE	MOD No.	REASON - INITIAL - DATE
							B		Configuration titles amended RSR - 19/05/2021
							C	ACN0153	OPTIONS Y & V MONITORING DETAILS RSR - 06/06/2024

OPTIONAL LINE MONITORING RESISTOR, CUSTOMER SUPPLIED,
RECOMMENDED MINIMUM VALUES:
14V MAX SYSTEM = 120Ω MIN, 2W MIN OR 1KΩ MIN, 0.5W MIN
28V MAX SYSTEM = 470Ω MIN, 2W MIN OR 2.4KΩ MIN, 0.5W MIN

Independent Sounder & Beacon Activation (Remove Link Wires)

Single Stage Configuration	Config.: 5a	Two Stage Configuration	Config.: 5b	Three/Four Stage Configuration	Config.: 5c
Line Monitoring Set to positive switching (default)		Common Negative Set to positive switching (default)		Common Negative Set to positive switching (default)	
Stage 1: Apply Power to Stage 1 +ve & Stage 1 -ve		Stage 1: Apply Power to Stage 1 +ve & Common -ve Stage 2: Apply Power to Stage 2 +ve & Common -ve		Stage 1: Apply Power to Stage 1 +ve & Common -ve Stage 2: Apply Power to Stage 2 +ve & Common -ve Stage 3: Apply Power to Stage 3 +ve & Common -ve Stage 4: Apply Power to Stage 2 +ve, Stage 3 +ve & Common -ve	

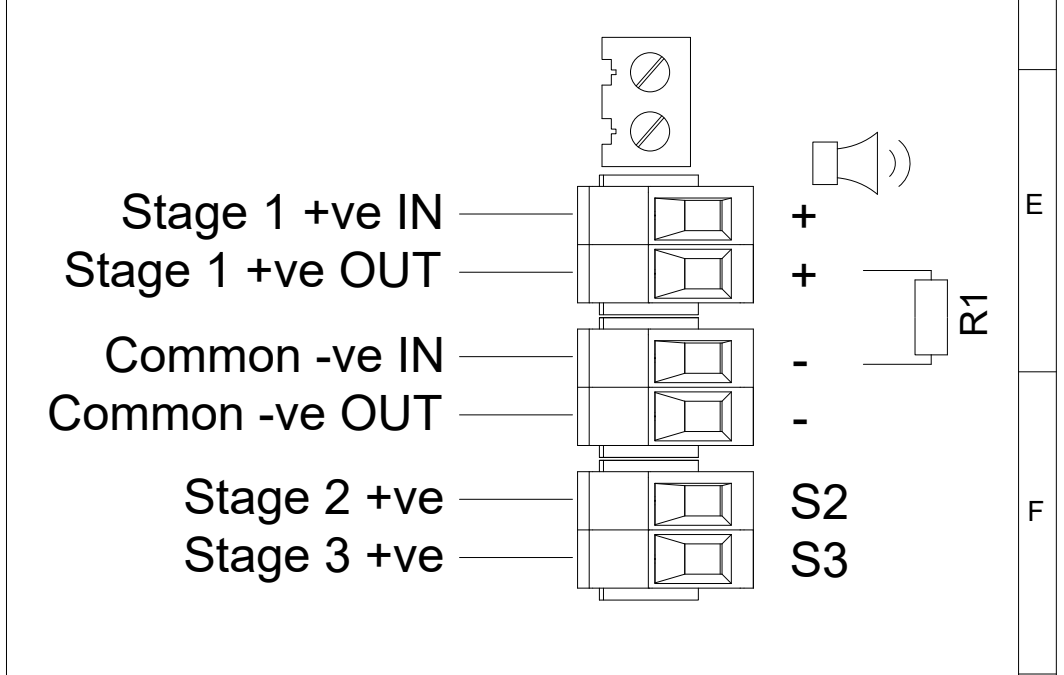
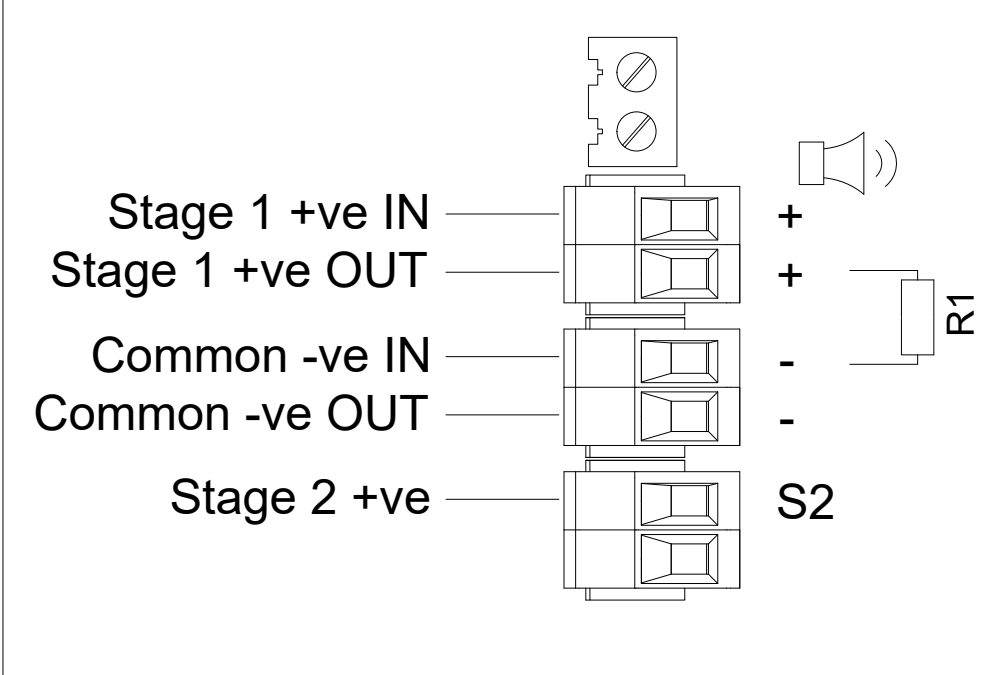
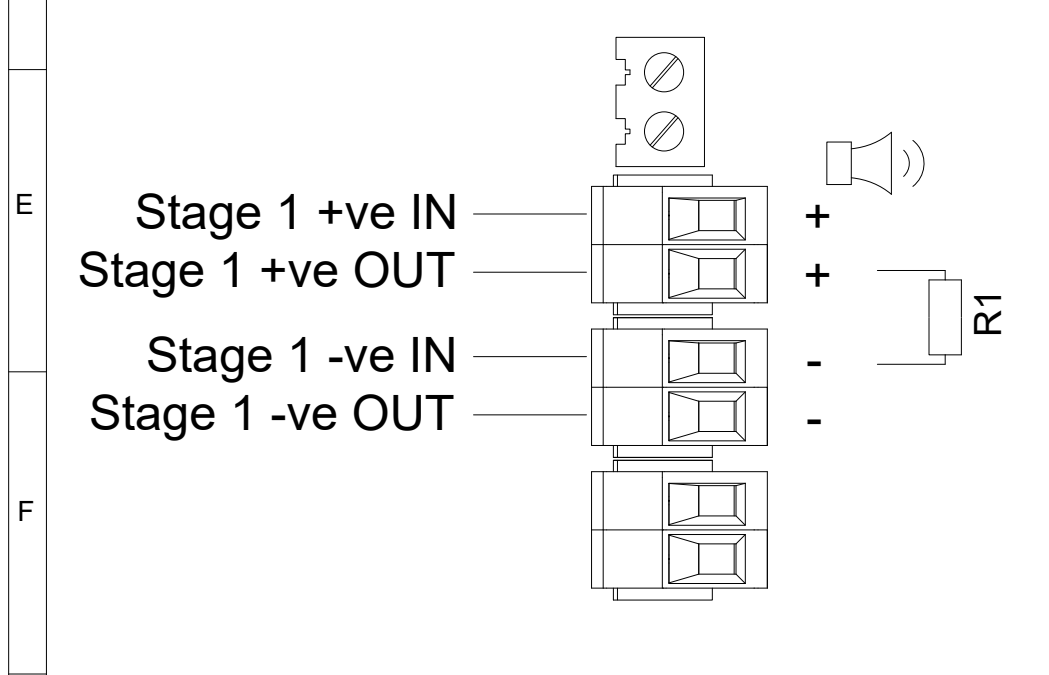
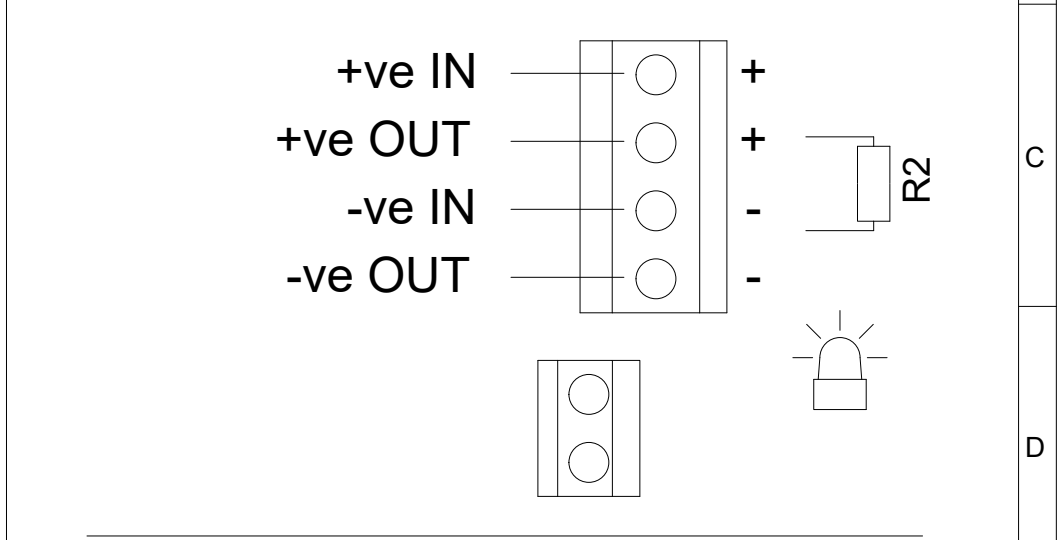
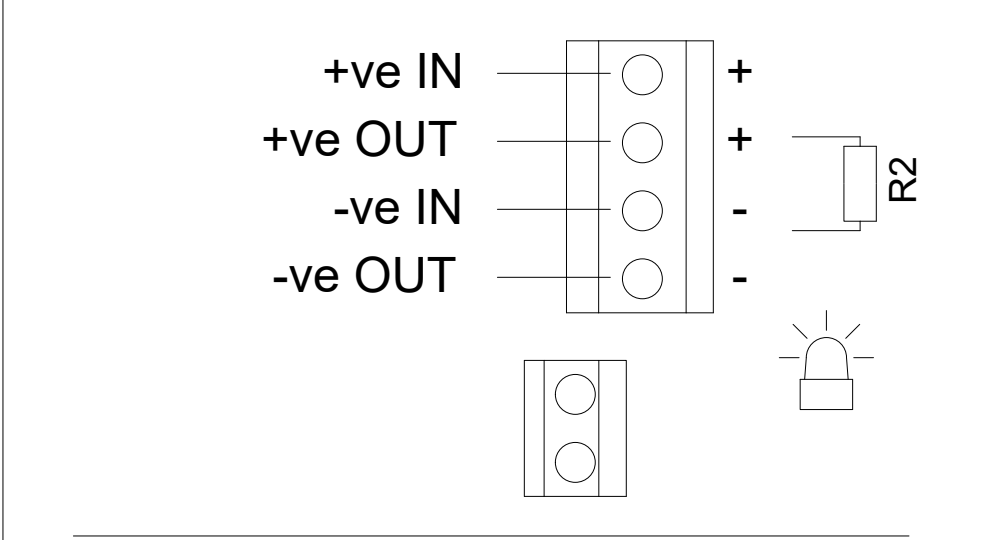
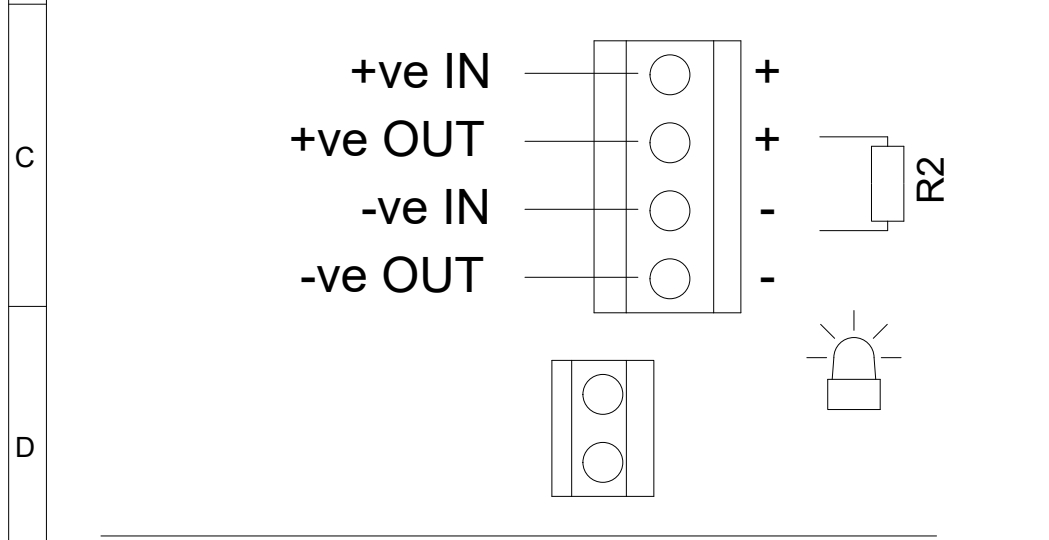

DRAWING TO BS8888:2000 GEOMETRIC TOLERANCES TO ISO1101:1983 LINEAR DIMENSIONAL TOLS ANGULAR DIMENSIONAL TOLS	DRAWN	DATE	SURFACE FINISH	WEIGHT (Kg)	THIS DRAWING AND ANY INFORMATION OR DESCRIPTIVE MATTER THEREIN IS COMMUNICATED IN CONFIDENCE AND IS THE COPYRIGHT PROPERTY OF EUROPEAN SAFETY SYSTEMS LTD. NEITHER THE WHOLE OR ANY EXTRACT MAY BE DISCLOSED, LOANED, COPIED OR USED FOR MANUFACTURING OR TENDERING PURPOSES WITHOUT THEIR WRITTEN CONSENT.	 warning signals EUROPEAN SAFETY SYSTEMS LTD IMPRESS HOUSE MANSSELL ROAD ACTON LONDON W3 7QH WWW.E2S.COM	ALL DIMENSIONS IN MM			A3
	R.S.RAIT	05/03/2021					IF IN DOUBT, ASK - DO NOT SCALE			
	CHECKED	DATE	MATERIAL				TITLE MC1X05 DC COMBINED SOUNDER XENON BEACON WIRING DIAGRAMS			
	B.ISARD	05/03/2021	ALTERNATIVE MATERIAL				SCALE	SHEET	DRAWING NUMBER	
STANDARDS	APPROVED	DATE	© EUROPEAN SAFETY SYSTEMS LTD. AS PER LATEST DATE OF ISSUE SHOWN ABOVE			NTS 4 OF 6		D207-06-501		
M RANGE	R.N.POTTS	05/03/2021								

1	2	3	4	5	6	7	8	9	10
							ISSUE	MOD No.	REASON - INITIAL - DATE
							B		Configuration titles amended RSR - 19/05/2021
							C	ACN0152	OPTIONS Y & V MONITORING DETAILS RSR - 06/06/2024

OPTIONAL LINE MONITORING RESISTOR, CUSTOMER SUPPLIED,
RECOMMENDED MINIMUM VALUES:
14V MAX SYSTEM = 120Ω MIN, 2W MIN OR 1KΩ MIN, 0.5W MIN
28V MAX SYSTEM = 470Ω MIN, 2W MIN OR 2.4KΩ MIN, 0.5W MIN

SWITCHES FOR STAGE OPERATION
CUSTOMER SUPPLIED

Independent Sounder & Beacon Activation (Remove Link Wire)

Three/Four Stages. Voltage Free 2nd, 3rd & 4th Stage Activation Configuration	Config.: 2	Two Stage Configuration	Config.: 7
-------------------------------------------------------------------------------	------------	-------------------------	------------

Common Positive
Customer Set H1 & H2 to Negative Switching (See Below)

Stage 1: Apply Power to Common +ve & Stage 1 -ve
Stage 2: Apply Power to Common +ve & Stage 1 -ve & connect Stage 2 -ve to Stage 1 -ve
Stage 3: Apply Power to Common +ve & Stage 1 -ve & connect Stage 3 -ve to Stage 1 -ve
Stage 4: Apply Power to Common +ve & Stage 1 -ve
& connect Stage 2 -ve & Stage 3 -ve to Stage 1 -ve

Independent Stage Input
Reverse Polarity Stage Monitoring

Stage 1: Apply Power to Stage 1 +ve & Stage 1 -ve
Stage 2: Apply Power to Stage 1 +ve & Stage 1 -ve & connect Stage 2 -ve to Stage 1 -ve

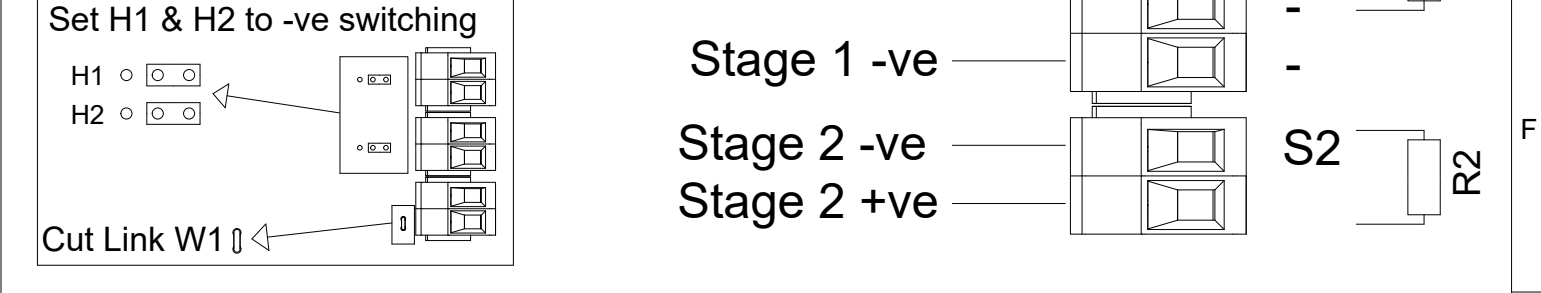
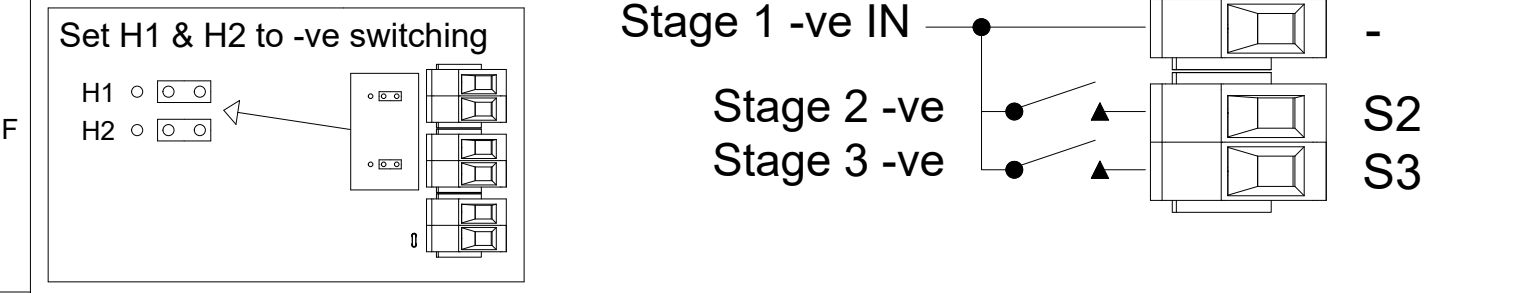
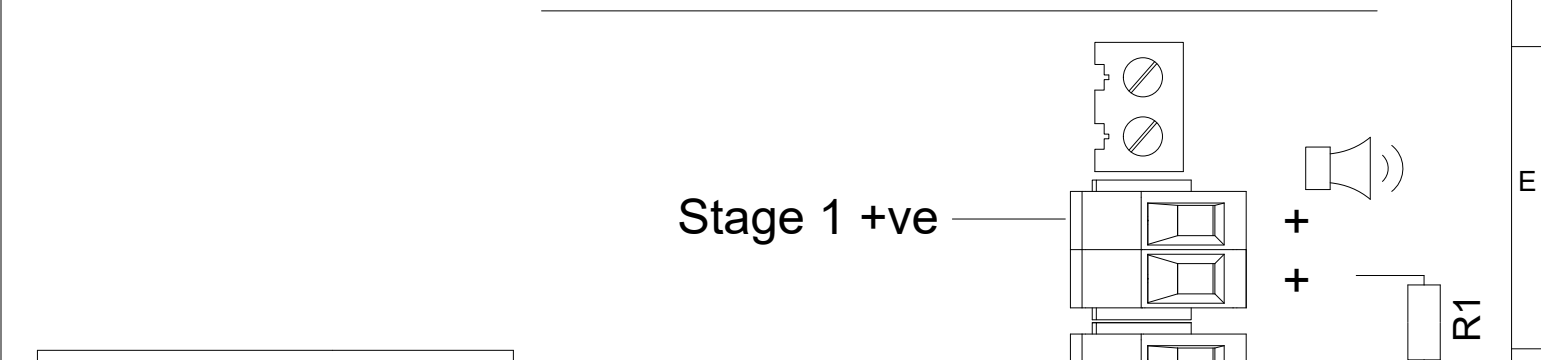
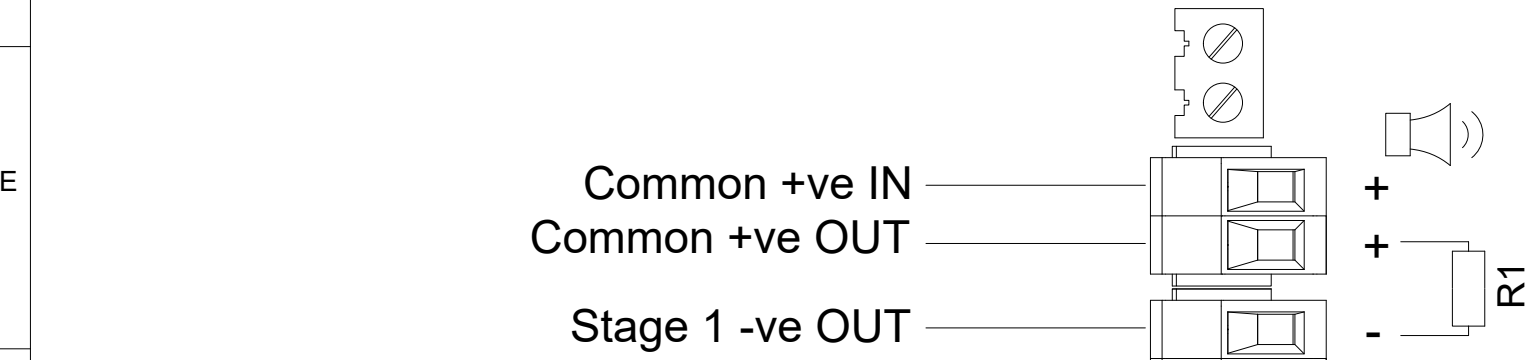
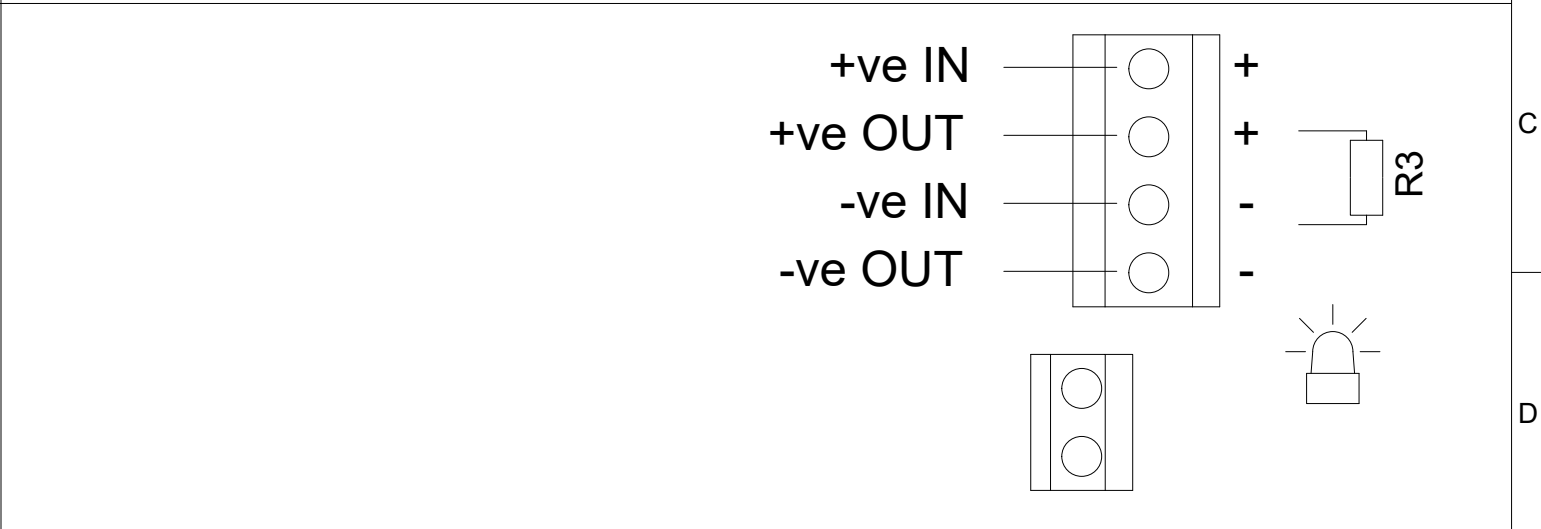
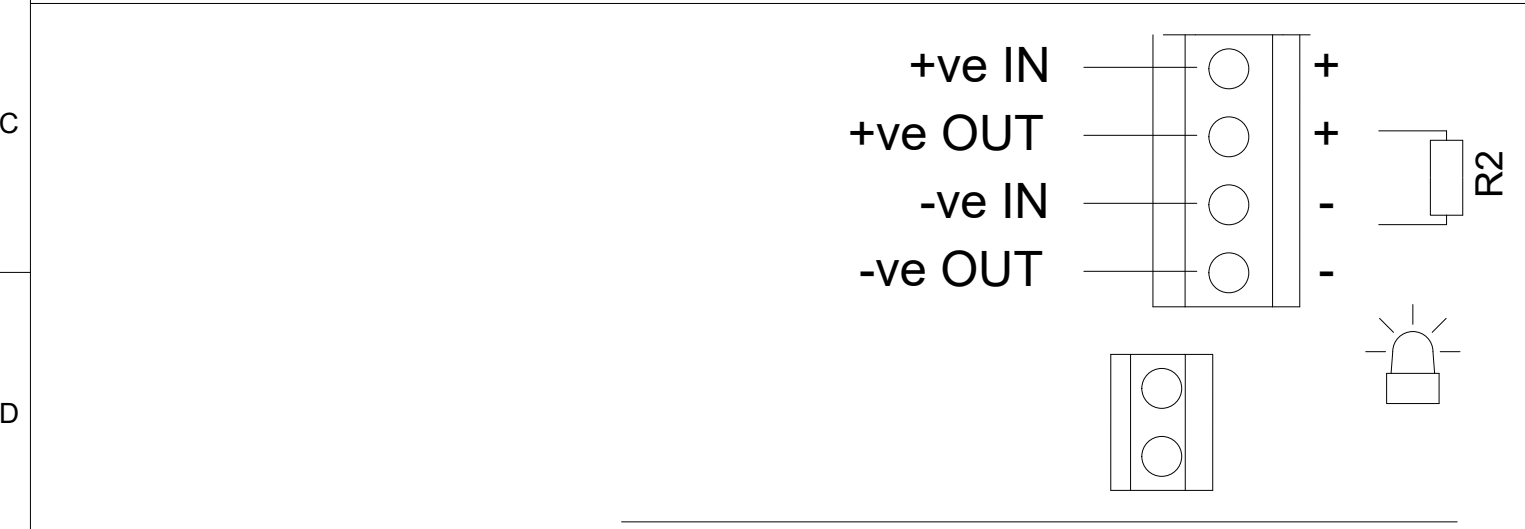

DRAWING TO BS8888:2000 GEOMETRIC TOLERANCES TO ISO1101:1983 LINEAR DIMENSIONAL TOLS ANGULAR DIMENSIONAL TOLS	DRAWN	DATE	SURFACE FINISH	WEIGHT (Kg)	THIS DRAWING AND ANY INFORMATION OR DESCRIPTIVE MATTER THEREIN IS COMMUNICATED IN CONFIDENCE AND IS THE COPYRIGHT PROPERTY OF EUROPEAN SAFETY SYSTEMS LTD. NEITHER THE WHOLE OR ANY EXTRACT MAY BE DISCLOSED, LOANED, COPIED OR USED FOR MANUFACTURING OR TENDERING PURPOSES WITHOUT THEIR WRITTEN CONSENT.	 warning signals EUROPEAN SAFETY SYSTEMS LTD IMPRESS HOUSE MANSELL ROAD ACTON LONDON W3 7QH WWW.E2S.COM	ALL DIMENSIONS IN MM			A3
	R.S.RAIT	05/03/2021					IF IN DOUBT, ASK - DO NOT SCALE			
	CHECKED	DATE	MATERIAL				TITLE MC1X05 DC COMBINED SOUNDER XENON BEACON WIRING DIAGRAMS			
	B.ISARD	05/03/2021	ALTERNATIVE MATERIAL				SCALE	SHEET	DRAWING NUMBER	
STANDARDS	APPROVED	DATE	EUROPEAN SAFETY SYSTEMS LTD. AS PER LATEST DATE OF ISSUE SHOWN ABOVE							
M RANGE	R.N.POTTS	05/03/2021				NTS	5 OF 6	D207-06-501		

----- WIRING LINKING BEACON & SOUNDER
FACTORY FITTED

SWITCHES FOR STAGE OPERATION
CUSTOMER SUPPLIED

Linked Sounder & Beacon Activation (Default)

Single Stage Configuration	Config.: 1a	Three/Four Stage Configuration	Config.: 1b
Stage 1: Apply Power to Stage 1 Live & Stage 1 Neutral		Stage 1: Apply Power to Live & Neutral Stage 2: Apply Power to Live & Neutral & connect Stage 2 to Common Stage 3: Apply Power to Live & Neutral & connect Stage 3 to Common	

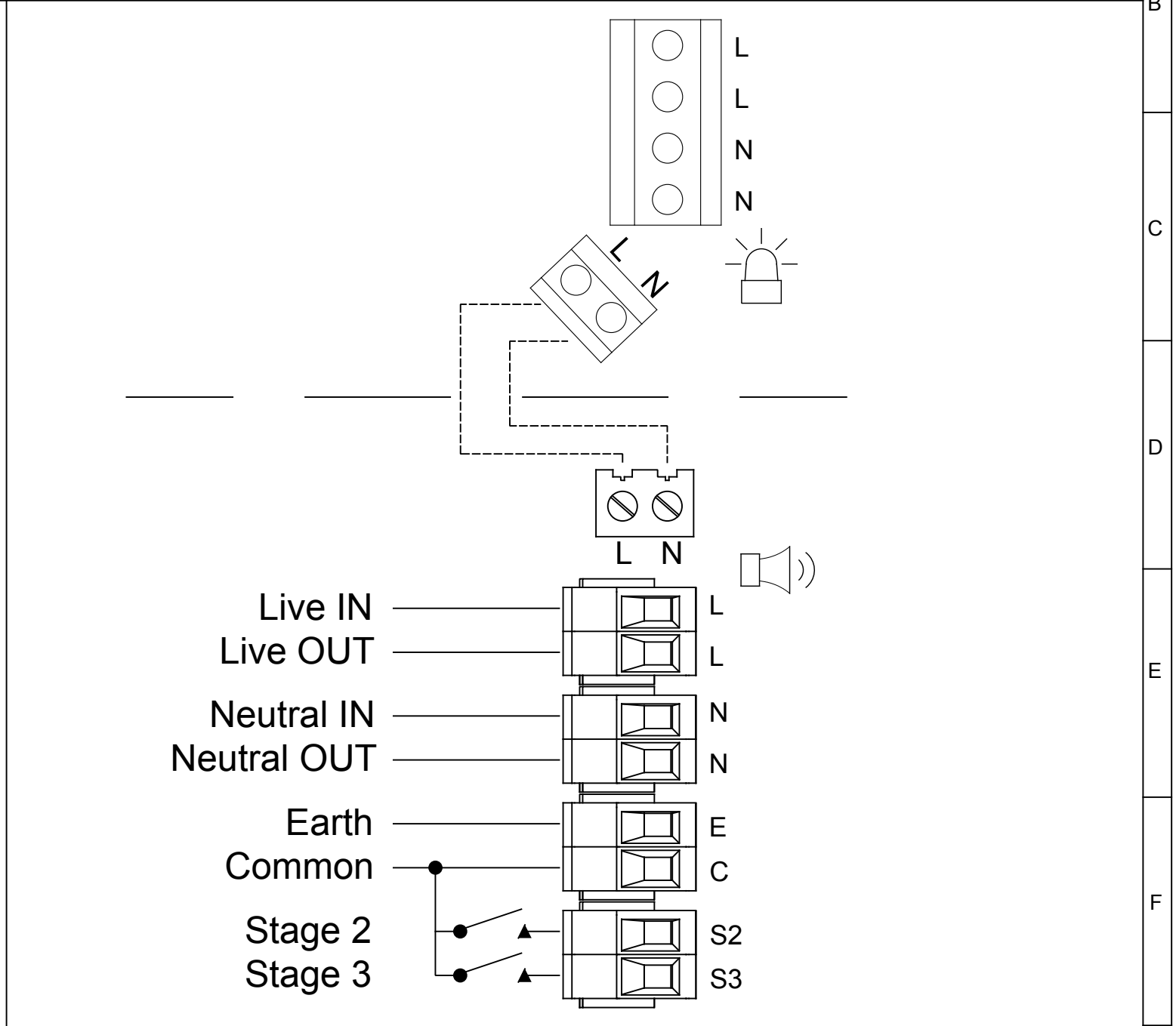
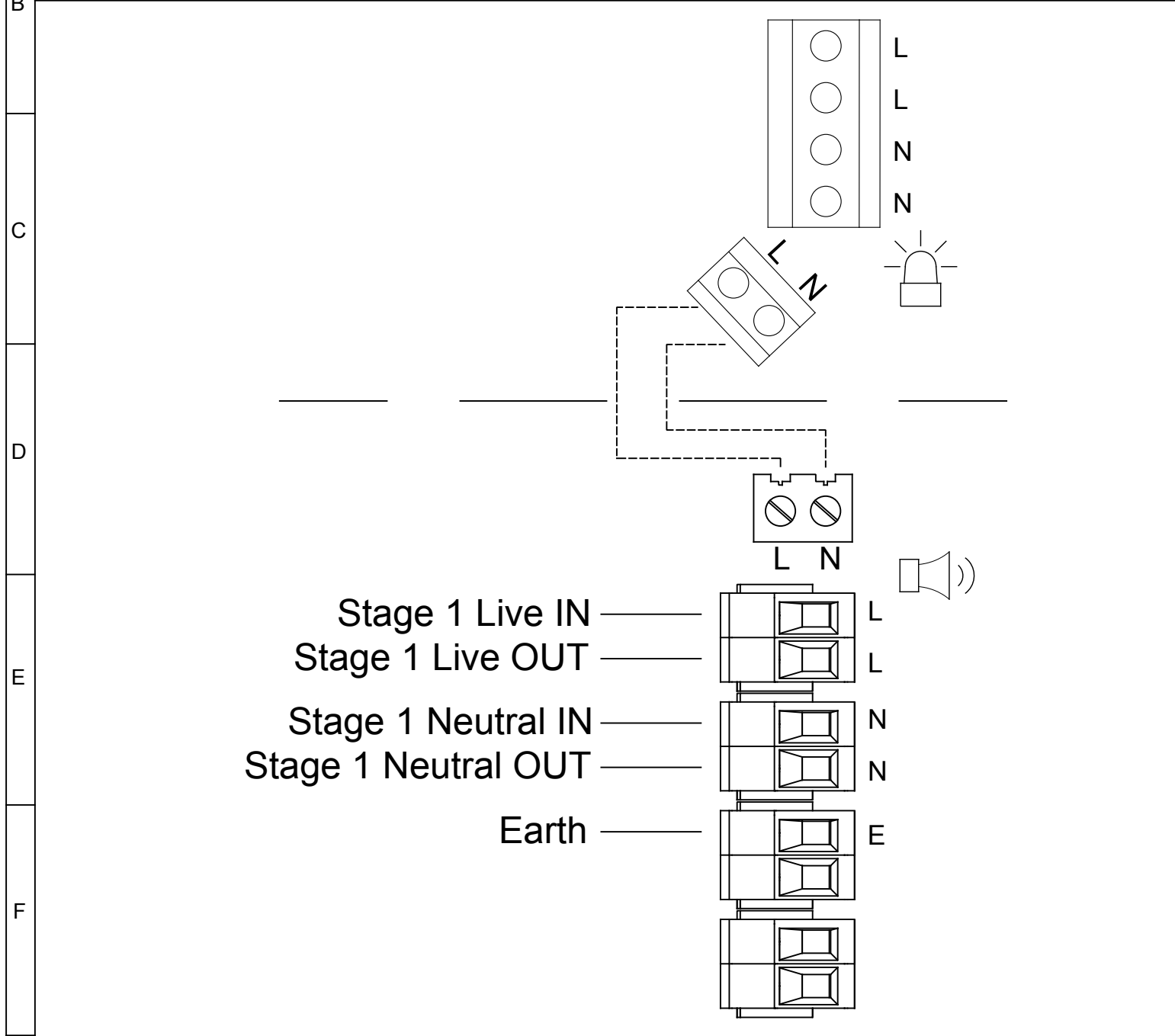

DRAWING TO BS8888:2000 GEOMETRIC TOLERANCES TO ISO1101:1983 LINEAR DIMENSIONAL TOLS ANGULAR DIMENSIONAL TOLS	DRAWN R.S.RAIT	DATE 05/03/2021	SURFACE FINISH	WEIGHT (Kg)	THIS DRAWING AND ANY INFORMATION OR DESCRIPTIVE MATTER THEREIN IS COMMUNICATED IN CONFIDENCE AND IS THE COPYRIGHT PROPERTY OF EUROPEAN SAFETY SYSTEMS LTD. NEITHER THE WHOLE OR ANY EXTRACT MAY BE DISCLOSED, LOANED, COPIED OR USED FOR MANUFACTURING OR TENDERING PURPOSES WITHOUT THEIR WRITTEN CONSENT.	 <small>EUROPEAN SAFETY SYSTEMS LTD IMPRESS HOUSE MANSELL ROAD ACTON LONDON W3 7QH WWW.E2S.COM</small>	ALL DIMENSIONS IN MM IF IN DOUBT, ASK - DO NOT SCALE		A3	
	CHECKED B.ISARD	DATE 05/03/2021	MATERIAL				TITLE MC1X05 AC COMBINED SOUNDER XENON BEACON WIRING DIAGRAMS	SCALE NTS	SHEET 1 OF 2	DRAWING NUMBER D207-06-505
	STANDARDS M RANGE	APPROVED R.N.POTTS	DATE 05/03/2021	ALTERNATIVE MATERIAL						

SWITCHES FOR STAGE OPERATION
 CUSTOMER SUPPLIED

Independent Sounder & Beacon Activation (Remove Link Wires)

Single Stage Configuration Config.: 2a
 Stage 1: Apply Power to Stage 1 Live & Stage 1 Neutral

Three/Four Stage Configuration Config.: 2b
 Stage 1: Apply Power to Live & Neutral
 Stage 2: Apply Power to Live & Neutral & connect Stage 2 to Common
 Stage 3: Apply Power to Live & Neutral & connect Stage 3 to Common

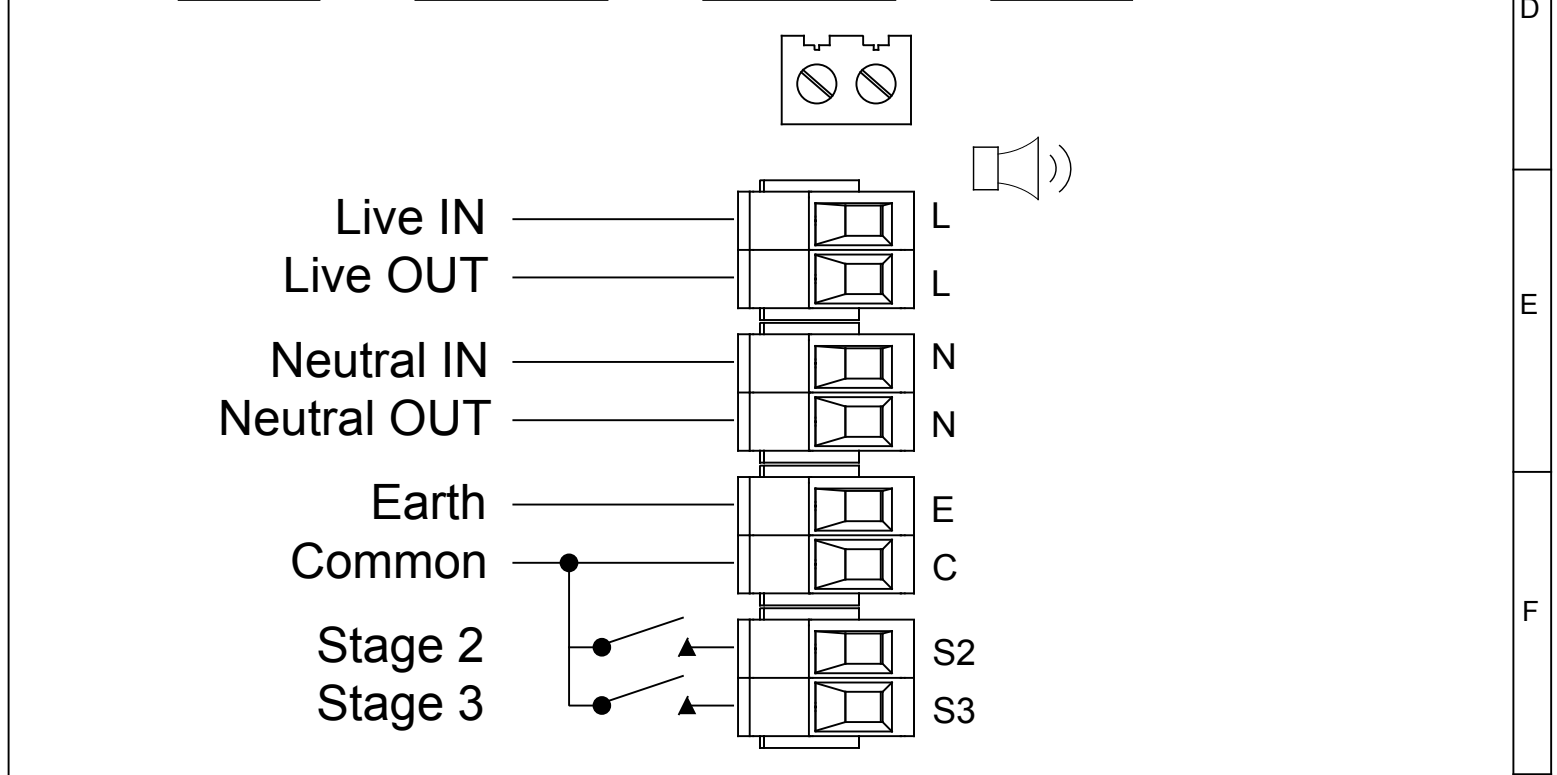
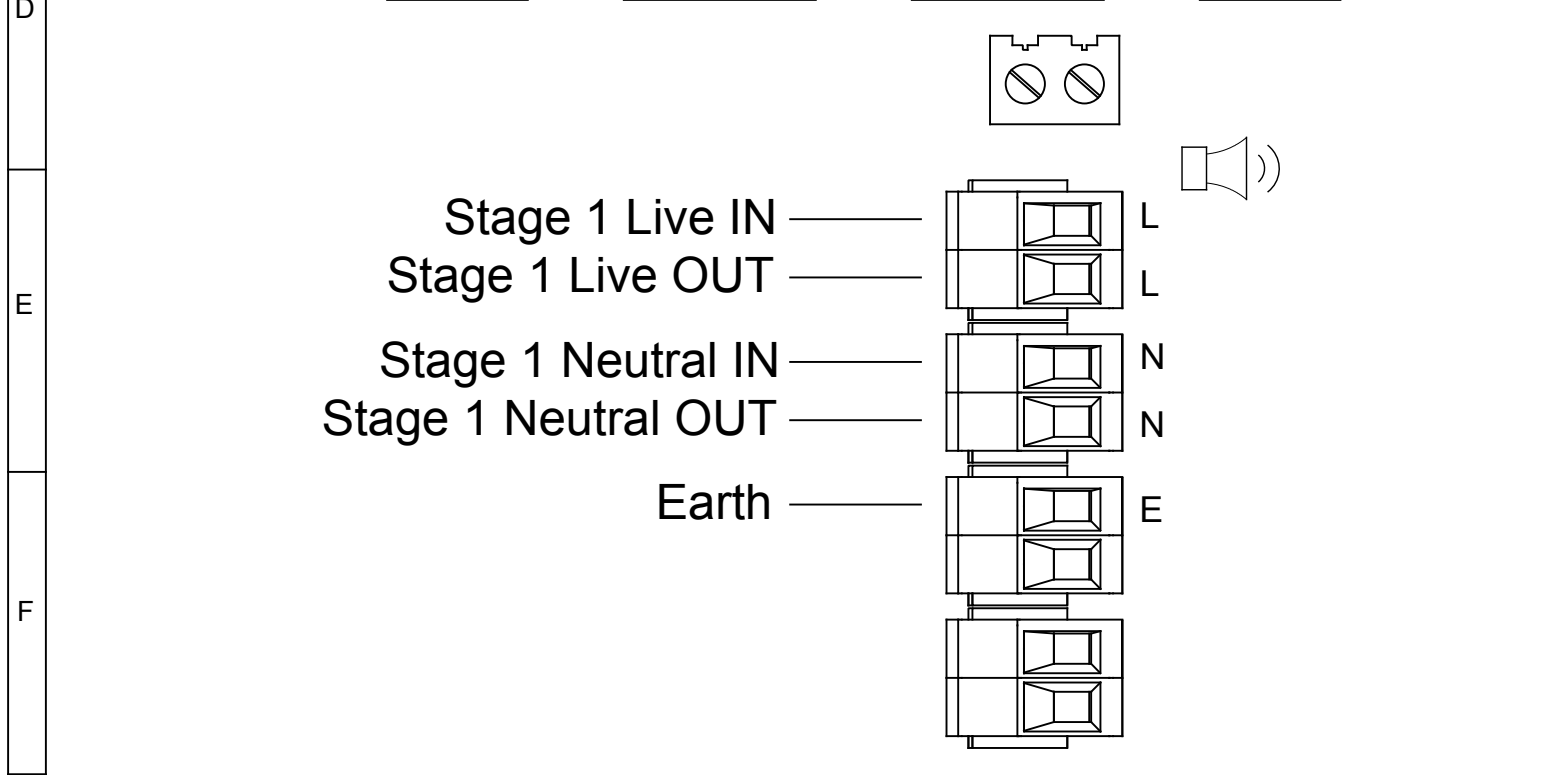
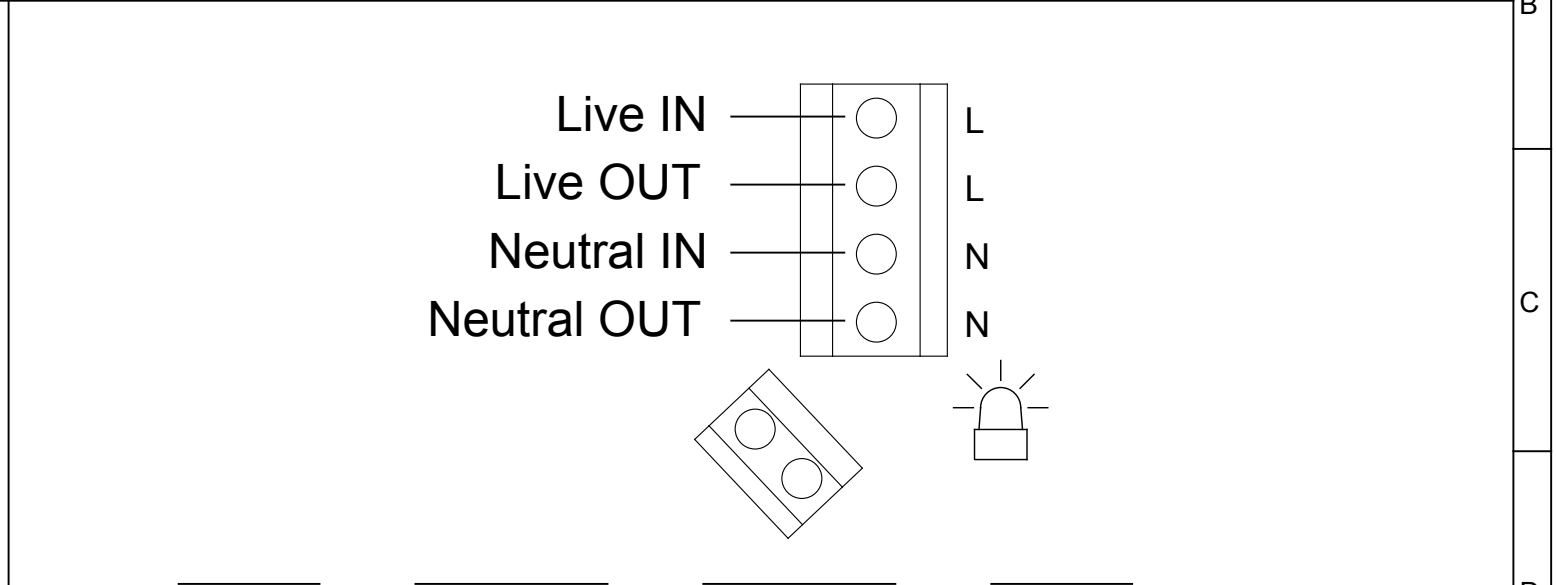
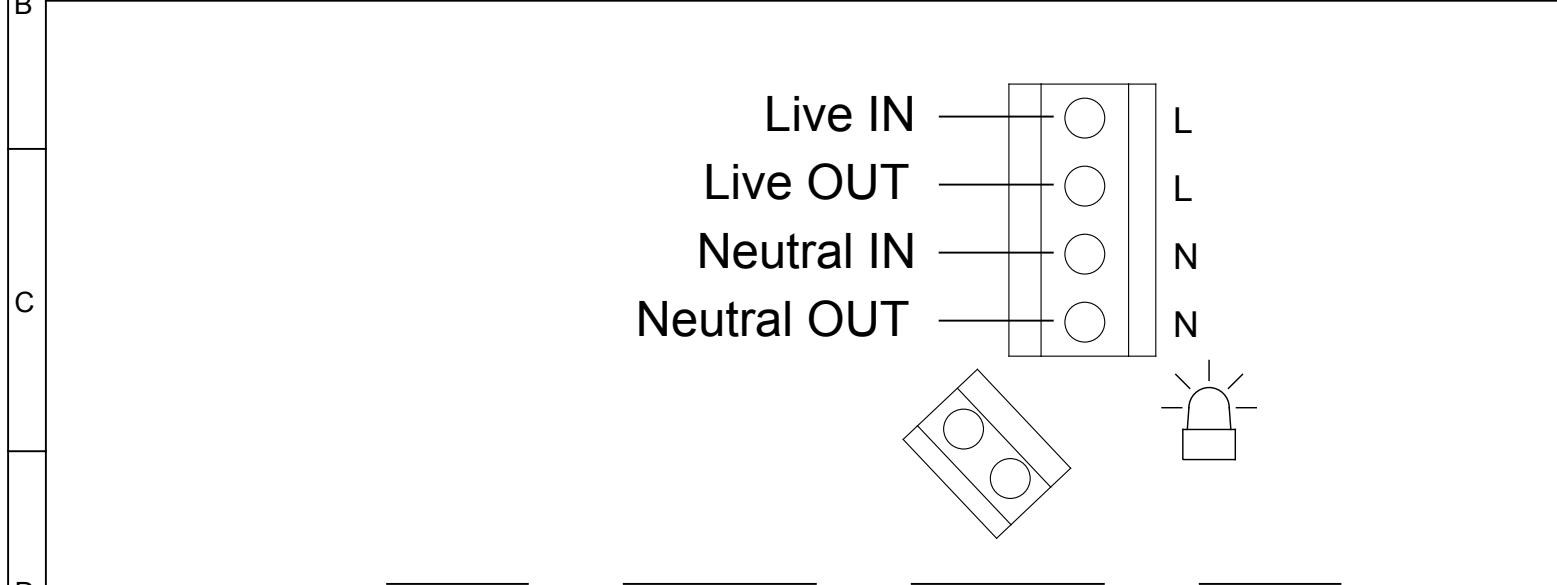

DRAWING TO BS8888:2000 GEOMETRIC TOLERANCES TO ISO1101:1983 LINEAR DIMENSIONAL TOLS ANGULAR DIMENSIONAL TOLS	DRAWN	DATE	SURFACE FINISH	WEIGHT (Kg)	THIS DRAWING AND ANY INFORMATION OR DESCRIPTIVE MATTER THEREIN IS COMMUNICATED IN CONFIDENCE AND IS THE COPYRIGHT PROPERTY OF EUROPEAN SAFETY SYSTEMS LTD. NEITHER THE WHOLE OR ANY EXTRACT MAY BE DISCLOSED, LOANED, COPIED OR USED FOR MANUFACTURING OR TENDERING PURPOSES WITHOUT THEIR WRITTEN CONSENT.	 <small>EUROPEAN SAFETY SYSTEMS LTD IMPRESS HOUSE MANSSELL ROAD ACTON LONDON W3 7QH WWW.E2S.COM</small>	ALL DIMENSIONS IN MM		A3
	R.S.RAIT	05/03/2021	MATERIAL	IF IN DOUBT, ASK - DO NOT SCALE					
	CHECKED	DATE	ALTERNATIVE MATERIAL	TITLE MC1X05 AC COMBINED SOUNDER XENON BEACON WIRING DIAGRAMS					
STANDARDS	B.ISARD	05/03/2021					SCALE	SHEET	DRAWING NUMBER
M RANGE	R.N.POTTS	05/03/2021					NTS	2 OF 2	D207-06-505