

INSTRUCTION MANUAL
BExS120D & BExS120D-R
Alarm Horn Sounder
ATEX/IECEX & UKEx Gas & Dust

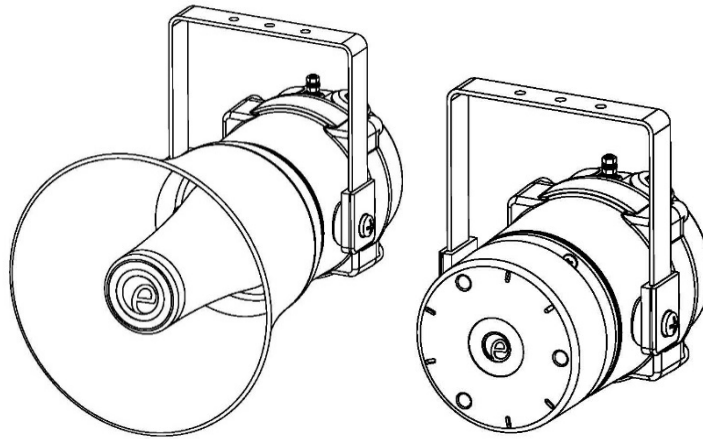

BExS120D

BExS120D-R

1. Product Table

Unit Type Code	Nominal Input Voltage	Nominal Input Current	Max I/P Voltage	Sound Pressure Level dB(A)	
				Max*	Nom.†
BExS120DDC012 / BExS120DDC012-R	12Vdc	850mA	15V	Flare: 123dB(A) Radial: 115dB(A)	Flare: 117dB(A) Radial: 110dB(A)
BExS120DDC024 / BExS120DDC024-R	24Vdc	800mA	30V		
BExS120DDC048 / BExS120DDC048-R	48Vdc	420mA	60V		
BExS120DAC115 / BExS120DAC115-R	115Vac	180mA	126V		
BExS120DAC230 / BExS120DAC230-R	230Vac	90mA	253V		
*Max = Tone 4 †Nom. = Tone 44 The table shows the input current taken by the various sounders. The current levels shown above are for the 440Hz Continuous tone @ nominal input voltage. Nominal current at nominal voltage.					
Table 1: Electrical Ratings.					

It is important that a suitable power supply is used to run the equipment. The power supply selected must have the necessary capacity to provide the input current to all of the units.

The above table shows the input current taken by the various sounders and shows the maximum voltage at which the sounders can be operated:

The input current will vary according to the voltage input level and the frequency of the tone selected.

2. Warnings



- DO NOT OPEN WHEN AN EXPLOSIVE ATMOSPHERE IS PRESENT
- DO NOT OPEN WHEN ENERGIZED
- POTENTIAL ELECTROSTATIC CHARGING HAZARD – CLEAN ONLY WITH A DAMP CLOTH
- COVER BOLTS CLASS A4-80
- USE HEAT RESISTING CABLES AND CABLE GLANDS (RATED 110°C) AT AMB. TEMPERATURES OVER 40°C

3. Marking & Rating Information

The BExS120D Alarm Horns comply with the following standards for hazardous locations:

3.1 ATEX / IECEx & UKEx Ratings

Standards	
EN60079-0:2018/IEC60079-0:2017 (ed.7):	Explosive Atmospheres - Equipment General Requirements.
EN60079-1:2014/IEC60079-1:2014 (ed.7):	Explosive Atmospheres - Equipment Protection by Flameproof Enclosures "d".
EN60079-31:2014/IEC60079-31:2013 (ed.2):	Explosive Atmospheres - Equipment Dust Ignition Protection by enclosure "t".
Model No:	Rating
BExS120D	Ex db IIC T4 Gb Ta. -50°C to +55°C Ex db IIB T4 Gb Ta. -50°C to +70°C Ex tb IIIC T100°C Db Ta. -50°C to +55°C Ex tb IIIC T115°C Db Ta. -50°C to +70°C
See Product table for electrical ratings of each unit model	

Certificate No. KEMA 99ATEX6312X
IECEX KEM 10.0003X
UL22UKEX2638X

Epsilon x
Equipment Group
and Category:



II 2G
II 2D

CE Marking and
Notified Body No.



2813

UKCA Marking and
Approval Body No.



0518

Area Classification Gas	
Zone 1	Explosive gas air mixture likely to occur in normal operation.
Zone 2	Explosive gas air mixture not likely to occur in normal operation, and if it does, it will only exist for a short time.
Gas Groupings	
Group IIA	Propane
Group IIB	Ethylene
Group IIC	Hydrogen and Acetylene (up to 55°C ambient)
Temperature Classification for Gas Applications	
T1	450° C
T2	300° C
T3	200° C
T4	135° C
Area Classification Dust	
Zone 21	Explosive dust air mixture likely to occur in normal operation.
Zone 22	Explosive dust air mixture not likely to occur in normal operation, and if it does, it will only exist for a short time.
Dust Groupings	
Group IIIA	Combustible Dusts
Group IIIB	Non-Conductive Dusts
Group IIIC	Conductive Dusts
Equipment Category	
2G, 2D	
Equipment Protection Level	
Gb, Db,	
Maximum Surface Temperature for Dust Applications	
100°C at +55°C 115°C at +70°C	
Ambient Temperature Range	
-50°C to +55°C Gas Groups IIA, IIB and IIC -50°C to +70°C Gas Groups IIA and IIB -50°C to +70°C Dust Groups IIIA, IIIB and IIIC	
IP Rating	
IP66/67 to EN/IEC60529 and IP6X to EN/IEC60079-0, EN/IEC60079-31	
The sounder must only be installed by suitably qualified personnel in accordance with the latest issues of the relevant standards:	
EN60079-14 / IEC60079-14: Explosive atmospheres - Electrical installations design, selection and erection EN60079-10-1 / IEC60079-10-1: Explosive atmospheres - Classification of areas. Explosive gas atmospheres EN60079-10-2 / IEC60079-10-2: Explosive atmospheres - Classification of areas. Explosive dust atmospheres	
The installation of the sounder must also be in accordance with any local codes that may apply and should only be carried out by a competent electrical engineer who has the necessary training.	

4. Zones, Gas Group, Category and Temperature Classification

The units can be installed in locations with the following conditions:

5. Special Conditions for Safe Use

Repair of the flamepath / flameproof joints is not permitted.

The enclosure is non-conducting and may generate an ignition-capable level of electrostatic charges under certain extreme conditions (such as high-pressure steam). The user should ensure that the equipment is not installed in a location where it may be subjected to external conditions that might cause a build-up of electrostatic charges on non-conducting surfaces.

Additionally, cleaning of the equipment should be done only with a damp cloth.

6. Product Mounting and Access

The location of the sounder should be made with due regard to the area over which the warning signal must be visible. They should only be fixed to services that can carry the weight of the unit.

The BEx sounder should be secured to any flat surface using at least two of the three 7mm fixing holes on the stainless steel U shaped mounting bracket. See Figure 1. The required angle can be achieved by loosening the two large bracket screws in the side of the unit, which allow adjustment of the sounder in steps of 18°. On completion of the installation then two large bracket adjustment screws on the side of the unit must be fully tightened to ensure that the unit cannot move in service.

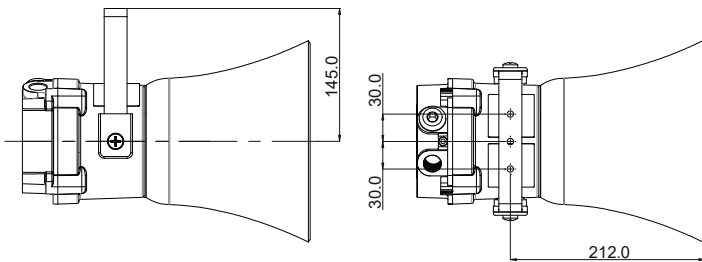

Fig. 1a Fixing Location for Sounder Flare

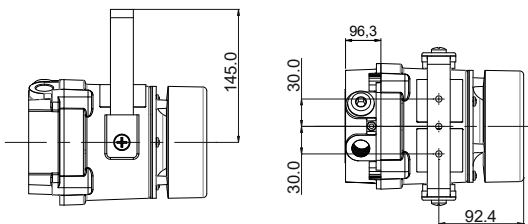

Fig. 1b Fixing Location for Sounder Radial

7. Access to the Flameproof Enclosure



Warning – High voltage may be present, risk of electric shock. DO NOT open when energised, disconnect power before opening.



Warning – Hot surfaces. External surfaces and internal components may be hot after operation, take care when handling the equipment.

To access the Ex d chamber, remove the four M6 hexagon socket head screws and withdraw the flameproof cover taking extreme care not to damage the flameproof joints in the process. M6 cover screws are Class A4-80 stainless steel and only screws of this category can be used for the enclosure.

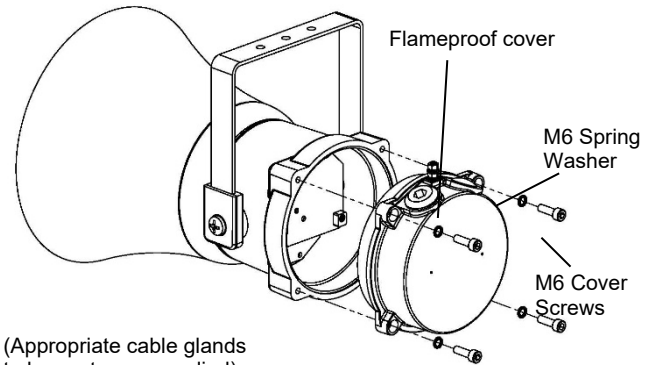

Fig. 2 Accessing the Explosion proof Enclosure.

On completion of the installation, the flameproof joints should be inspected to ensure that they are clean and that they have not been damaged during installation.

Check that the earth bonding wire between the two castings is secure and the 'O' ring seal is in place. When replacing the flameproof cover casting ensure that it is square with the flameproof chamber casting before inserting. Carefully push the cover in place allowing time for the air to be expelled. Only after the cover is fully in place should the four M6 Stainless Steel A4-80 cover bolts and their spring washer be inserted and tightened down. If the cover jams while it is being inserted, carefully remove it and try again. Never use the cover bolts to force the cover into position.

8. Selection of Cable. Cable Glands, Blanking Elements & Adapters

When selecting the cable size, consideration must be given to the input current that each unit draws (see table above), the number of sounders on the line and the length of the cable runs. The cable size selected must have the necessary capacity to provide the input current to all of the sounders connected to the line.

For ambient temperatures over +40°C the cable entry temperature may exceed +70°C and therefore suitable heat resisting cables and cable glands must be used, with a rated service temperature of at least 110°C

The dual cable gland entries have an M20 x 1.5 entry thread. To maintain the ingress protection rating and mode of protection, the cable entries must be fitted with suitably rated ATEX / IECEx or UKEx certified cable glands and/or suitably rated ATEX / IECEx or UKEx certified blanking devices during installation according to EN / IEC60079-14.

If a high IP (Ingress Protection) rating is required then a suitable sealing washer must be fitted under the cable glands or blanking plugs.

For use in explosive dust atmospheres, a minimum ingress protection rating of IP6X must be maintained.

The BEx sounder range can be supplied with the following types of adapters:

M20 to ½" NPT
M20 to ¾" NPT
M20 to M25

It is important to note that stopping plugs cannot be fitted onto adapters, only directly onto the M20 entries.

Any other adapters used must be suitably rated and ATEX / IECEx or UKEx certified adapters.

9. Earthing

Both AC and DC sounder units must be connected to an earth. The units are provided with internal and external earth terminals which are both located on the terminal chamber section of the unit.

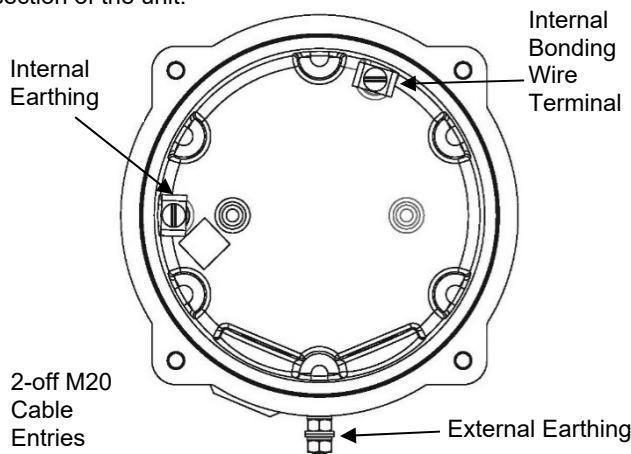

Fig. 3 Internal View of Cover

When using the internal earth terminal ensure that the stainless steel M4 flat washer is between the incoming earth wire and the enclosure.

Internal earthing connections should be made to the Internal Earth terminal in the base of the housing using a ring crimp

terminal to secure the earth conductor under the earth clamp. The earth conductor should be at least equal in size and rating to the incoming power conductors. Tighten M4 Earth screw to 1Nm.

External earthing connections should be made to the M5 earth stud, using a ring crimp terminal to secure the earth conductor to the earth stud. The external earth conductor should be at least 4mm² in size. Tighten the Earth nut to 3Nm. Please firmly tighten the external grounding terminal so that the stud does not become loose and lay the ground wire so that it is not caught by twisting and sagging.

10. Cable Connections

Electrical connections are to be made into the terminal blocks on the PCBA located in the flameproof enclosure. See section 7 of this manual for access to the flameproof enclosure.

Wires having a cross sectional area between 0.5 mm² to 2.5mm² can be connected to each terminal way. If an input and output wire is required the 2-off Live/Neutral or +/- terminals can be used. If fitting 2-off wires to one terminal way the sum of the 2-off wires must be a maximum cross sectional area of 2.5mm². Strip wires to 8mm. Wires may also be fitted using ferrules. Terminal screws need to be tightened down with a tightening torque of 0.45 Nm / 5 Lb-in. When connecting wires to the terminals great care should be taken to dress the wires so that when the cover is inserted into the chamber the wires do not exert excess pressure on the terminal blocks. This is particularly important when using cables with large cross sectional areas such as 2.5mm².

11. AC Wiring

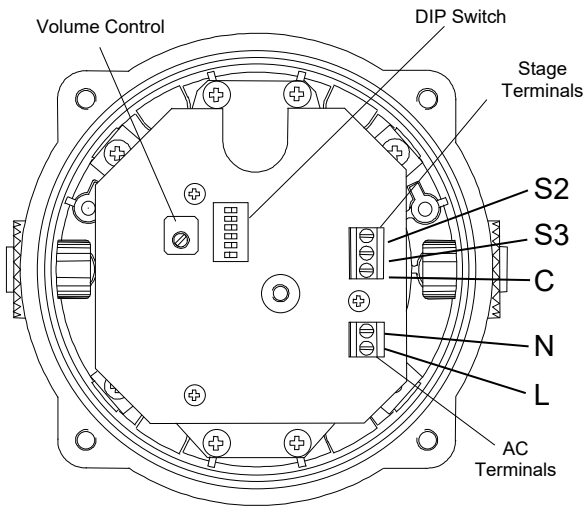

Fig. 4 AC Terminals

12. DC Wiring

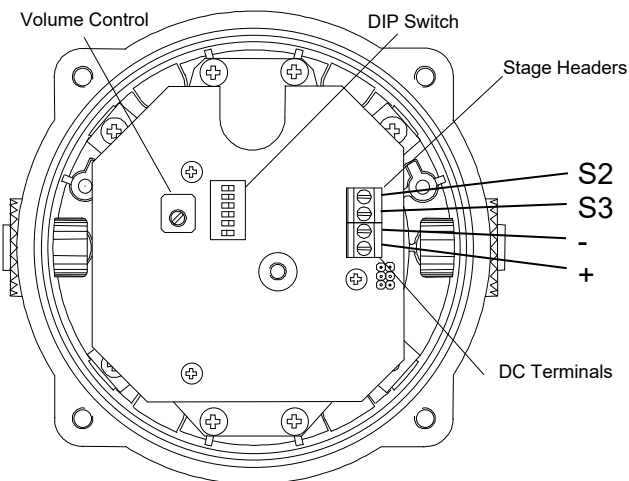

Fig. 6 DC Terminals

12.1 Stage Switching Polarity (DC Units Only)

The BExS120D DC sounders have the facility to use either +ve or -ve switching to change the tone to the second and third stages. Negative switching is the default setting. For -ve switching connect the two headers on the pcb to the left-hand (marked -ve) and centre pins. For +ve switching connect the headers to the right hand (marked +ve) and the centre pins. (Refer to Fig. 7)

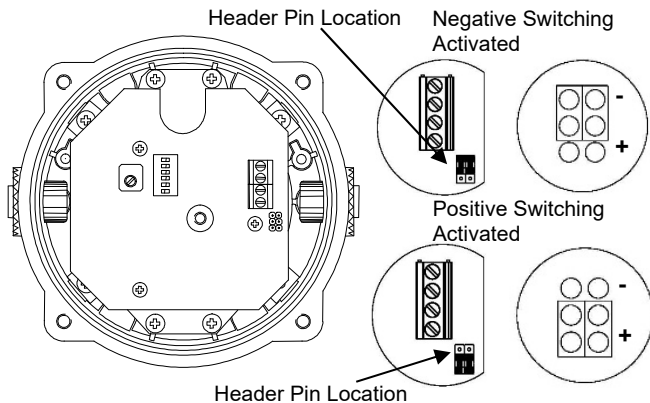

Fig. 7 Stage Switching Polarity

12.2 Line Monitoring

On BExS120D DC units, dc reverse line monitoring can be used if required. All DC sounders have a blocking diode fitted in their supply input lines. An end of line monitoring diode or an end of line monitoring resistor can be connected across the +ve and -ve terminals. If an end of line resistor is used it must have a minimum resistance value of $3k3\Omega$ and a minimum power rating of 0.5 watts or a minimum resistance value of 500Ω and a minimum power rating of 2 watts.

The resistor must be connected directly across the +ve and -ve terminals as shown in the following drawing. The resistor leads should be kept as short as possible.

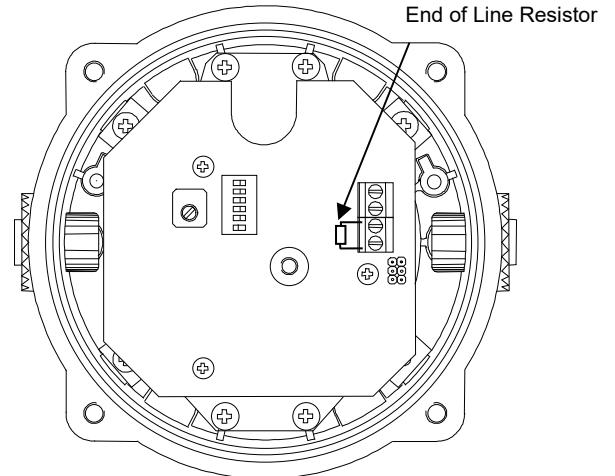

Fig. 8 End of Line Resistor Placement

13. Settings

13.1 Tone Settings

The sounders have 32 different tones that can be selected for the first stage alarm. The sounders can then be switched to sound second and third stage alarm tones. The tones are selected by operation of a DIP switch on the pcb for both DC and AC units. The tone table D210-95-001-IS shows the switch positions for the 32 tones and which tones are available for the second and third stages. To operate the sounder on stage one simply connect the supply voltage to the normal supply terminals (+ve and -ve for DC units, L and N for AC units). Refer to wiring schematics D210-06-001 (DC) or D210-06-005 (AC).

Default =
Tone 1
0 0 0 0 0 0

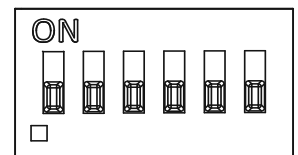

(ON = 1, OFF = 0)

Figure 9: DIP switch configuration

13.2 Volume Control



Warning - High noise levels above 85dB(A) during operation. High levels of noise may cause hearing loss, wear suitable ear protection when equipment is in operation.

The output level of the BEx sounder can be set by adjusting

Volume Control Potentiometer

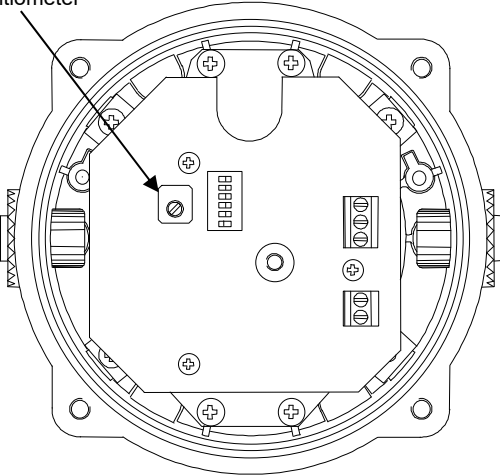

BExS120D AC

Volume Control Potentiometer

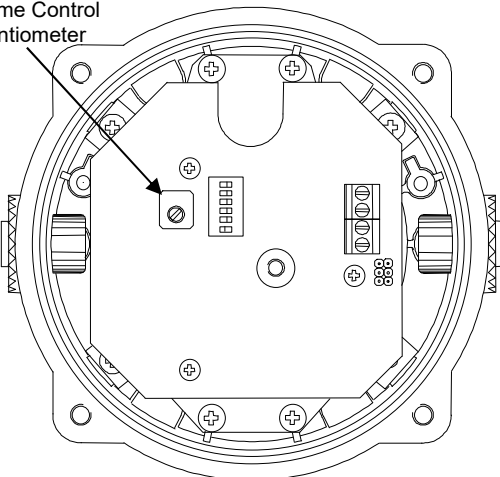

BExS120D DC

Fig.10 Location of Volume Control Potentiometer

14. Maintenance, Overhaul & Repair











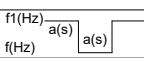
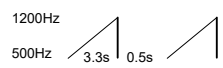
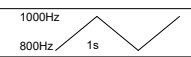

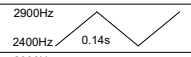

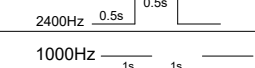
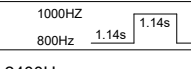
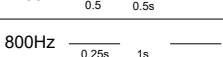
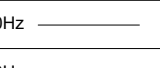
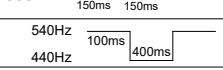
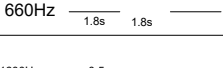
Maintenance, repair and overhaul of the equipment should only be carried out by suitably qualified personnel in accordance with the current relevant standards:

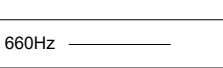
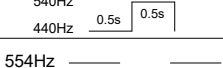
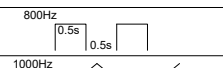
- EN60079-19 Explosive atmospheres - Equipment repair, overhaul and reclamation
- IEC60079-19
- EN 60079-17 Explosive atmospheres - Electrical installations inspection and maintenance
- IEC60079-17

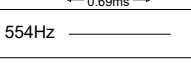
The acoustic horn is made out of ABS plastic, therefore to avoid a possible ELECTROSTATIC CHARGE the unit must only be cleaned with a damp cloth.

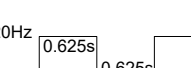
Units must not be opened while an explosive atmosphere is present.

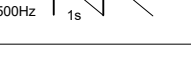
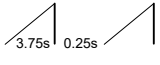
If opening the unit during maintenance operations a clean environment must be maintained and any dust layer removed prior to opening the unit.

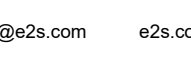
Stage 1 Set DIP SW 1 Tone No.	Tone Description	Tone Visual	Stage 1 DIP SW 1 Settings 1 2 3 4 5 6	Stage 2	Stage 3
1	Continuous 1000Hz Toxic Gas Alarm	1000Hz 	0 0 0 0 0	1	11
2	Alternating 800/1000Hz at 0.25s Intervals		1 0 0 0 0	17	5
3	Slow Whoop 500/1200Hz at 0.3Hz with 0.5s gap repeated		0 1 0 0 0	2	5
4	Sweeping 800/1000Hz at 1Hz		1 1 0 0 0	6	5
5	Continuous at 2400Hz	2400Hz 	0 0 1 0 0	3	27
6	Sweeping 2400/2900Hz at 7Hz		1 0 1 0 0	7	5
7	Sweeping 2400/2900Hz at 1Hz		0 1 1 0 0	10	5
8	Siren 500/1200/500Hz at 0.3Hz		1 1 1 0 0	2	5
9	Sawtooth 1200/500Hz at 1Hz		0 0 0 1 0	15	2
10	Alternating 2400/2900Hz at 2Hz		1 0 0 1 0	7	5
11	Intermittent 1000Hz at 0.5Hz General Alarm	1000Hz 	0 1 0 1 0	31	1
12	Alternating 800/1000Hz at 0.875Hz		1 1 0 1 0	4	5
13	Intermittent 2400Hz at 1Hz	2400Hz 	0 0 1 1 0	15	5
14	Intermittent 800Hz 0.25s on 1s off	800Hz 	1 0 1 1 0	4	5
15	Continuous at 800Hz	800Hz 	0 1 1 1 0	2	5
16	Intermittent 660Hz 150mS on, 150mS off	660Hz 	1 1 1 1 0	18	5
17	Alternating 544Hz (100mS)/440Hz(400mS)		0 0 0 0 1	2	27
18	Intermittent 660Hz 1.8s on, 1.8s off	660Hz 	1 0 0 0 1	2	5
19	1400Hz to 1600Hz sweep up over 1s - 1600Hz to 1400Hz sweep down over 0.5s		0 1 0 0 1	2	5
20	Continuous 660Hz	660Hz 	1 1 0 0 1	2	5
21	Alternating 554/440Hz at 1Hz		0 0 1 0 1	2	5
22	Intermittent 554Hz at 0.875Hz	554Hz 	1 0 1 0 1	2	5
23	800Hz pulsing at 2Hz	800Hz 	0 1 1 0 1	6	5
24	Sweeping 800/1000Hz at 50Hz		1 1 1 0 1	29	5
25	Sweeping 2400/2900Hz at 50Hz		0 0 0 1 1	29	5
26	Simulated Bell Sound	1450Hz 	1 0 0 1 1	2	1
27	Continuous 554Hz	554Hz 	0 1 0 1 1	26	5
28	Continuous 440Hz	440Hz 	1 1 0 1 1	2	5
29	Sweeping 800/1000Hz at 7Hz		0 0 1 1 1	7	5
30	420Hz repeating 0.625s on, 0.625s off Australiian Alert Signal	420Hz	1 0 1 1 1	32	5
31	1200/500Hz at 1Hz Prepare to Abandon Platform		0 1 1 1 1	11	1
32	Sweeping 500/1200Hz 3.75s on, 0.25s off 15Hz		1 1 1 1 1	26	1

1	2	3	4	5	6	7	8	9	10
							ISSUE	MOD No.	REASON - INITIAL - DATE
							1		INTRODUCTION RSR - 08/03/2022

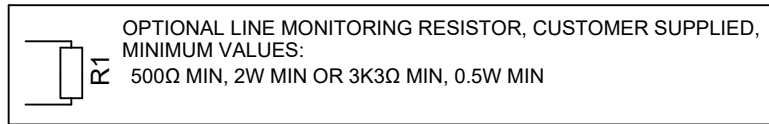

Single Stage Configuration	Config.: 1a	Two Stage Configuration	Config.: 1b	Three Stage Configuration	Config.: 1c
Optional Line Monitoring Header pins set to negative switching (default)		Optional Line Monitoring (Stage 1 only) Common Positive Header pins set to negative switching (default)		Optional Line Monitoring (Stage 1 only) Common Negative Set header pins to positive switching	
Stage 1: Apply Power to Stage 1 +ve & Stage 1 -ve		Stage 1: Apply Power to +ve & -ve Stage 2: Apply Power to +ve & -ve, Connect Stage 2 to -ve Stage 3: Apply Power to +ve & -ve, Connect Stage 3 to -ve		Stage 1: Apply Power to +ve & -ve Stage 2: Apply Power to +ve & -ve, Connect Stage 2 to +ve Stage 3: Apply Power to +ve & -ve, Connect Stage 3 to +ve	

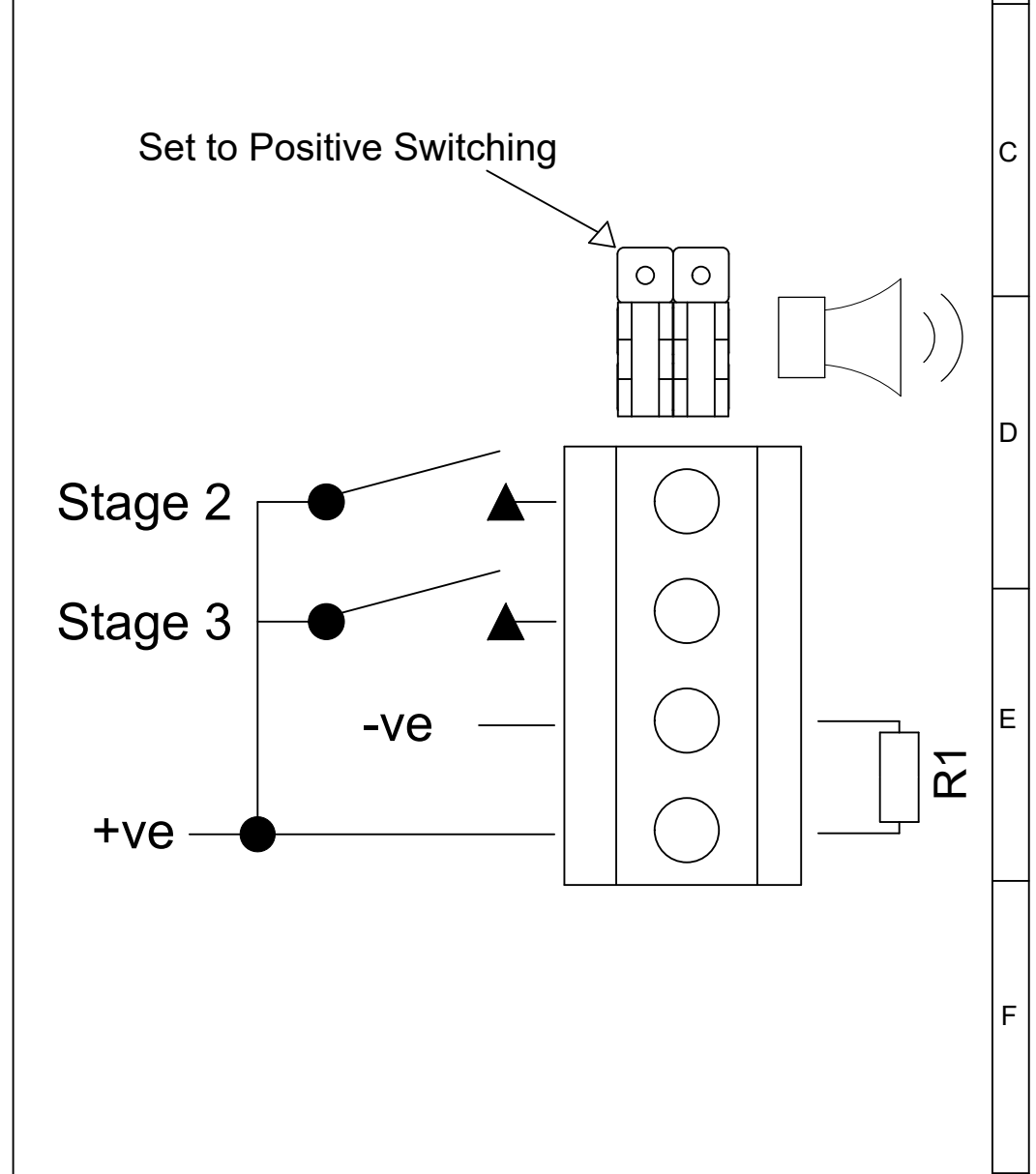
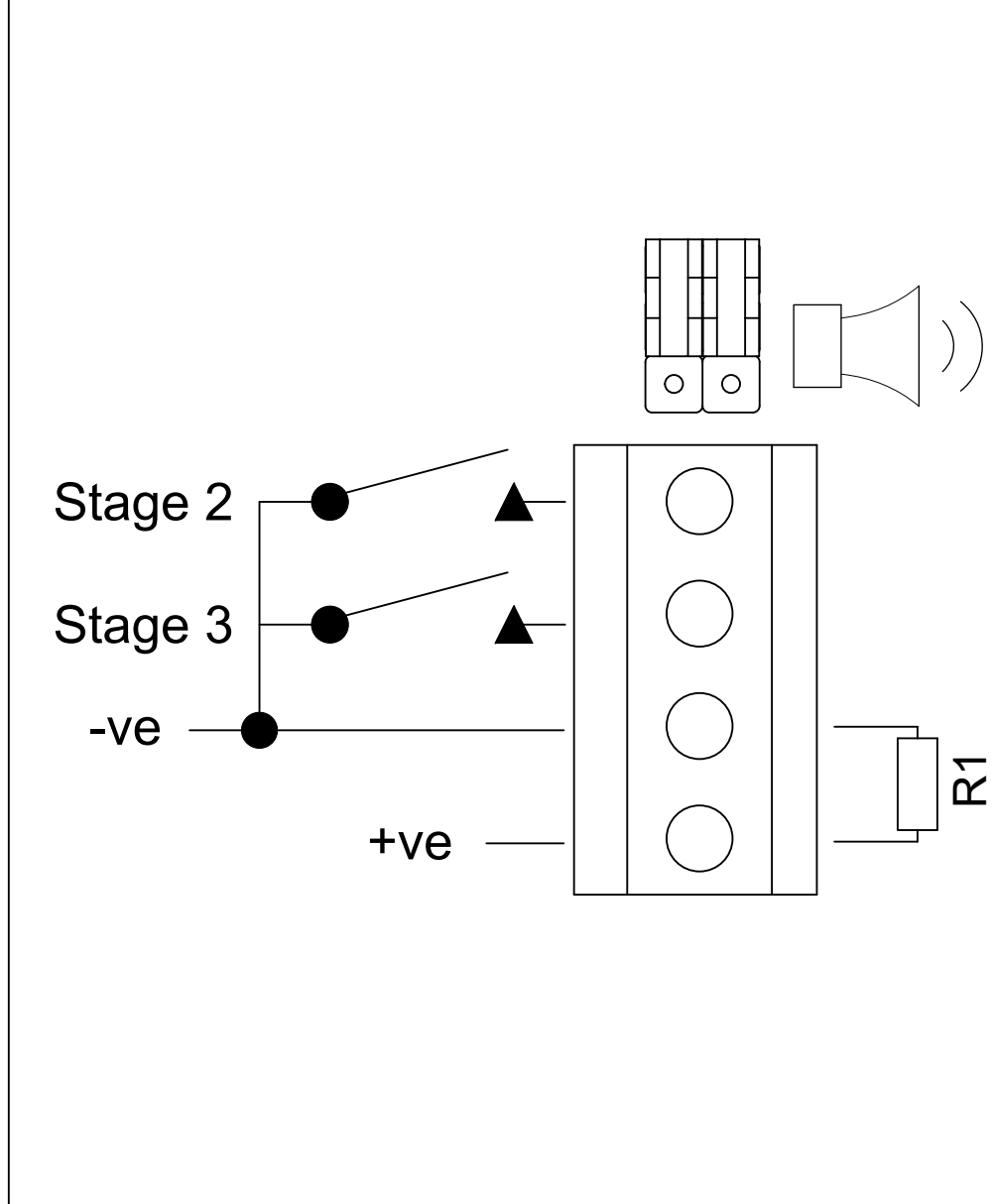
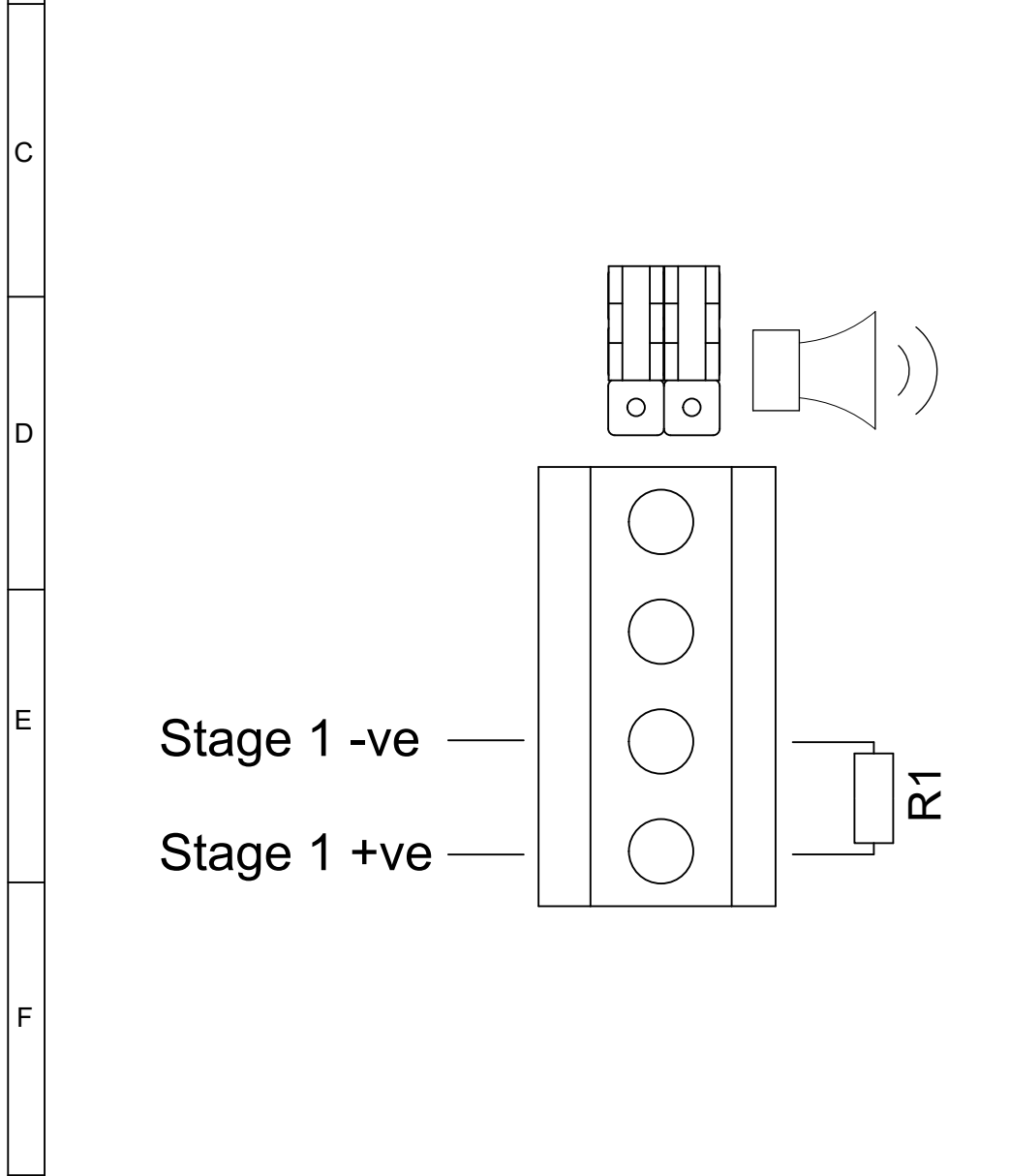

DRAWING TO BS8888:2000 GEOMETRIC TOLERANCES TO ISO1101:1983 LINEAR DIMENSIONAL TOLS ANGULAR DIMENSIONAL TOLS	DRAWN	DATE	SURFACE FINISH	WEIGHT (Kg)	THIS DRAWING AND ANY INFORMATION OR DESCRIPTIVE MATTER THEREIN IS COMMUNICATED IN CONFIDENCE AND IS THE COPYRIGHT PROPERTY OF EUROPEAN SAFETY SYSTEMS LTD. NEITHER THE WHOLE OR ANY EXTRACT MAY BE DISCLOSED, LOANED, COPIED OR USED FOR MANUFACTURING OR TENDERING PURPOSES WITHOUT THEIR WRITTEN CONSENT. © EUROPEAN SAFETY SYSTEMS LTD. AS PER LATEST DATE OF ISSUE SHOWN ABOVE	EUROPEAN SAFETY SYSTEMS LTD IMPRESS HOUSE MANSSELL ROAD ACTON LONDON W3 7QH WWW.E2S.COM	ALL DIMENSIONS IN MM IF IN DOUBT, ASK - DO NOT SCALE		A3		
	CHECKED	DATE	MATERIAL				TITLE	SCALE	SHEET	DRAWING NUMBER	
	STANDARDS	APPROVED	DATE	ALTERNATIVE MATERIAL			BExS110D & BExS120D DC SOUNDER WIRING DIAGRAMS	NTS	1 OF 1	D210-06-001	
	BEx	R.N.POTTS	08/03/2022								



1	2	3	4	5	6	7	8	9	10
							ISSUE	MOD No.	REASON - INITIAL - DATE
							1		INTRODUCTION RSR - 24/03/2022

SWITCHES FOR STAGE OPERATION
CUSTOMER SUPPLIED

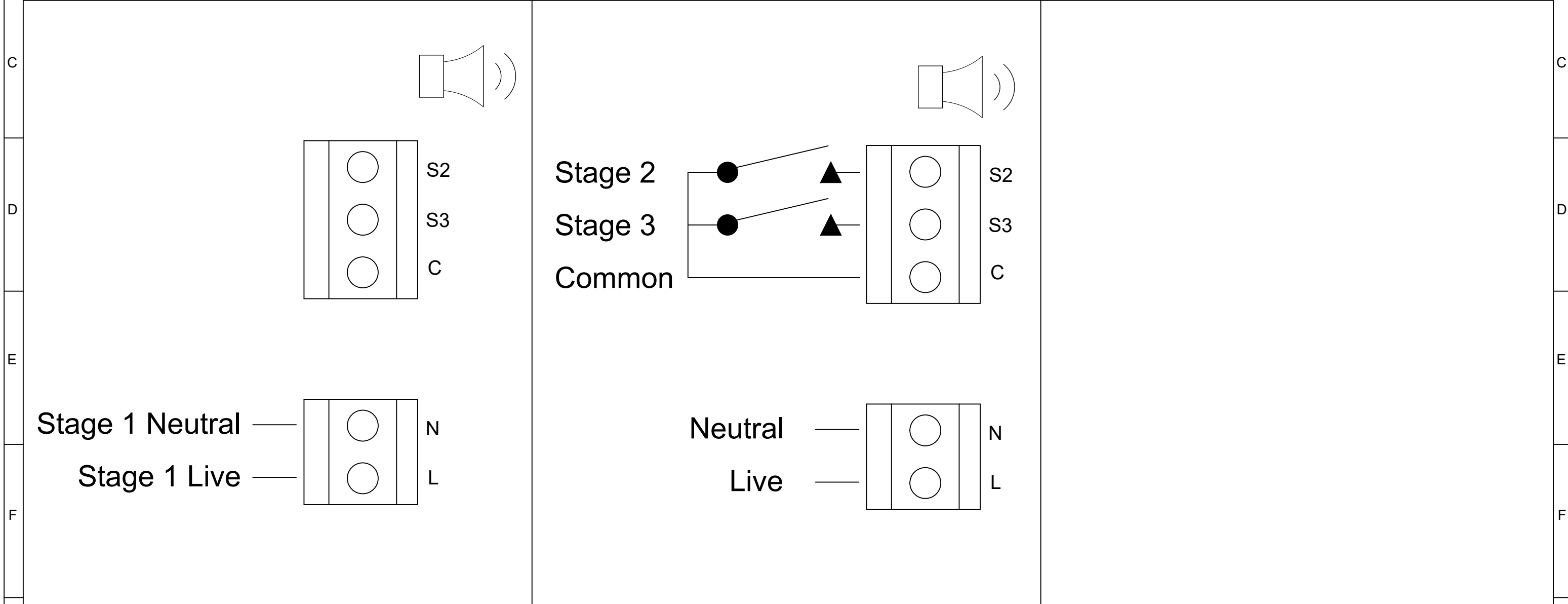

Single Stage Configuration	Config.: 1a	Two/Three Stage Configuration	Config.: 1b
Stage 1: Apply Power to Stage 1 Live & Stage 1 Neutral		Stage 1: Apply Power to Live & Neutral Stage 2: Apply Power to Live & Neutral & connect Stage 2 to Common Stage 3: Apply Power to Live & Neutral & connect Stage 3 to Common	



DRAWING TO BS8888:2000 GEOMETRIC TOLERANCES TO ISO1101:1983 LINEAR DIMENSIONAL TOLS ANGULAR DIMENSIONAL TOLS	DRAWN R.S.RAIT	DATE 08/03/2022	SURFACE FINISH	WEIGHT (Kg)	THIS DRAWING AND ANY INFORMATION OR DESCRIPTIVE MATTER THEREIN IS COMMUNICATED IN CONFIDENCE AND IS THE COPYRIGHT PROPERTY OF EUROPEAN SAFETY SYSTEMS LTD. NEITHER THE WHOLE OR ANY EXTRACT MAY BE DISCLOSED, LOANED, COPIED OR USED FOR MANUFACTURING OR TENDERING PURPOSES WITHOUT THEIR WRITTEN CONSENT.	 EUROPEAN SAFETY SYSTEMS LTD IMPRESS HOUSE MANSELL ROAD ACTON LONDON W3 7QH WWW.E2S.COM	ALL DIMENSIONS IN MM IF IN DOUBT, ASK - DO NOT SCALE	 	A3
	CHECKED B.ISARD	DATE 08/03/2022	MATERIAL	TITLE BExS110D & BExS120D AC SOUNDER WIRING DIAGRAMS					
	STANDARDS BEx	APPROVED R.N.POTTS	DATE 08/03/2022	ALTERNATIVE MATERIAL			SCALE NTS	SHEET 1 OF 1	DRAWING NUMBER D210-06-005

EU Declaration of Conformity



Manufacturer: European Safety Systems Ltd.
Impress House, Mansell Road, Acton
London, W3 7QH
United Kingdom

Authorised Representative: E2S Warnsignaltechnik UG
Charlottenstrasse 45-51
72764 Reutlingen
Germany

Equipment Type: Electronic Sounders, Types BExS110D(-R)(-SIL), BExS120D(-R),
Electronic Sounders, Types BExS110E(-R), BExS120E(-R),
Loudspeakers, Types BExL15D(-R), BExL25D(-R),
Loudspeakers, Types BExL15E(-R), BExL25E(-R),
Appello Speech Sounders, Types BExA110(-R),
Sontel, Types BExTS110D(-R),
Hootronic Sounder, Types BExH120D(-R),
Monitored Loudspeaker, Types BExL25GD(-R)

Directive 2014/34/EU: Equipment and Protective Systems for use in Potentially Explosive Atmospheres (ATEX)

Notified Body for EU type Examination (Module B):	Dekra Certification B.V. Notified Body No.: 0344 Meander 1051, 6825 MJ Arnhem, The Netherlands
EU-type Examination Certificate (Module B):	KEMA 99ATEX6312X
Notified Body for Quality Assurance Notification / Conformity to EU-type based on quality assurance of the production process (Module D):	Sira Certification Service Notified Body No.: 2813 CSA Group Netherlands B.V, Utrechtseweg 310, 6812 AR, Arnhem, Netherlands
Quality Assurance Notification (Module D):	SIRA 05 ATEX M342
Provisions fulfilled by the equipment:	II 2G Ex db IIB or IIC T4 Gb II 2G Ex db eb IIB or IIC T4 Gb II 2D Ex tb IIIC T100 °C or T105 °C or T115 °C Db
Standards applied:	EN IEC 60079-0 : 2018 EN 60079-1 : 2014 EN 60079-7 : 2015 + A1 : 2018 EN 60079-31 : 2014

Regulation EU No. 305/2011: Construction Products Regulation (CPR) – BExS110D24DC/BExS120D24DC (tones 2, 3, 9, 15, 16, 17) only

Notified Product Certification Body for Certificate of Constancy of Performance or EC Type Examination Certificate and continuous surveillance, assessment and evaluation of factory production control:	VdS Schadenverhütung GmbH Notified Body No.: 0786 Amsterdamer Str 172-174, 50735 Köln, Germany
Certificate of Constancy of Performance or EC Type Examination Certificate:	0708-CPD-20225
Standards applied:	EN 54-3:2001 + A1:2002

Directive 2014/90/EU: Marine Equipment Directive (MED) – part codes specified below only - BExS110D24DC-M only

Notified Body for EU type Examination (Module B) and Conformity to EU-type based on quality assurance of the production process (Module D):	DNV GL SE Notified Body No.: 0098 Brooktorkai 18, 20457 Hamburg, Germany
EU-Certificate Type Examination (Module B):	MEDB00001BU
EU Certificate of Conformity for the Quality Assurance System (Module D):	MEDD00000GV
Standards applied:	EN 54-3:2014 incl. A1: 2019 IEC 60092-504: 2016

EU Declaration of Conformity



IEC 60533: 2015

Directive 2014/30/EU: Electromagnetic Compatibility Directive (EMC)

Standards applied:

EN 61000-6-1:2007
EN 61000-6-2:2005
EN 61000-6-3:2007 + A1:2011 + AC: 2012
EN 61000-6-4:2007 + A1: 2011

Directive 2011/65/EU: Restriction of the use of certain hazardous substances in electrical and electronic equipment (RoHS)

The product and all the components contained within it are in accordance with the restriction of the use of hazardous substances in electrical and electronic equipment, including amendment by Directive 2015/863/EU.

Regulation (EC) 1907/2006: Registration, Evaluation, Authorisation and Restriction of Chemicals (REACH)

The product and all the components contained within it are free from substances of very high concern.

Other Standards and Regulations

EN 60529:1991 + A1:2000 + A2:2013. - Degrees of protection provided by enclosures (IP code) – enclosure rated IP66/67

On behalf of European Safety Systems Ltd., I declare that, on the date the equipment accompanied by this declaration is placed on the market, the equipment conforms with all technical and regulatory requirements of the above listed directives, regulations and standards.

This Declaration is issued under the sole responsibility of the manufacturer.

A handwritten signature in black ink, appearing to read 'Martin Streetz'.

Martin Streetz
Quality Assurance Manager

Document No.: DC-001_Issue_O
Date and Place of Issue: London, 20/04/2022



UKCA Declaration of Conformity



Manufacturer: European Safety Systems Ltd.
Impress House, Mansell Road, Acton
London, W3 7QH
United Kingdom

Equipment Type: Electronic Sounders, Types BExS110D(-R)(-SIL), BExS120D(-R),
Electronic Sounders, Types BExS110E(-R), BExS120E(-R),
Loudspeakers, Types BExL15D(-R), BExL25D(-R),
Loudspeakers, Types BExL15E(-R), BExL25E(-R),
Appello Speech Sounders, Types BExA110(-R),
Sontel, Types BExTS110D(-R),
Hootronic Sounder, Types BExH120D(-R),
Monitored Loudspeaker, Types BExL25GD(-R)

Directive UKSI 2016:1107 (as amended by UKSI 2019:696) – Schedule 3A, Part 1 : Product or Protective System Intended for use in Potentially Explosive Atmospheres (UKCA)

Notified Body for UK type Examination (Module B):	UL International (UK) Ltd Notified Body No.: 0843 Unit 1-3 Horizon Kingsland Business Park, Wade Road, Basingstoke, Hampshire RG24 8AH UK
UK-type Examination Certificate (Module B):	UL21UKEX2638X
Notified Body for Quality Assurance Notification / Conformity to EU-type based on quality assurance of the production process (Module D):	Sira Certification Service Notified Body No.: 0518 Rake Lane, Eccleston, Chester CH4 9JN, UK
Quality Assurance Notification (Module D):	CSAE 22UKQAN0046
Provisions fulfilled by the equipment:	II 2G Ex db IIB <i>or</i> IIC T4 Gb II 2G Ex db eb IIB <i>or</i> IIC T4 Gb II 2D Ex tb IIIC T100°C <i>or</i> T105°C <i>or</i> T115° Db IP6X Dust Protection to EN60079-0 / EN60079-31
Standards applied:	EN IEC 60079-0: 2018 EN 60079-1: 2014 EN IEC 60079-7: 2015 + A1: 2018 EN 60079-31: 2014

Directive 2014/30/EU: Electromagnetic Compatibility Directive (EMC)

Standards applied:	EN 61000-6-1:2007 EN 61000-6-2:2005 EN 61000-6-3:2007 / A1:2011 / AC: 2012 EN 61000-6-4:2007 / A1: 2011
--------------------	------------------------------------------------------------------------------------------------------------------

Directive 2011/65/EU: Restriction of the use of certain hazardous substances in electrical and electronic equipment (RoHS)

The product and all the components contained within it are in accordance with the restriction of the use of hazardous substances in electrical and electronic equipment, including amendment by Directive 2015/863/EU.

Regulation (EC) 1907/2006: Registration, Evaluation, Authorisation and Restriction of Chemicals (REACH)

The product and all the components contained within it are free from substances of very high concern.

Other Standards and Regulations

EN 60529:1991 / A1:2000 / A2:2013 - Degrees of protection provided by enclosures (IP code) – enclosure rated IP66/67

UKCA Declaration of Conformity



On behalf of European Safety Systems Ltd., I declare that, on the date the equipment accompanied by this declaration is placed on the market, the equipment conforms with all technical and regulatory requirements of the above listed directives, regulations and standards.

This Declaration is issued under the sole responsibility of the manufacturer.

A handwritten signature in black ink, appearing to read 'Martin Streetz'.

Martin Streetz
Quality Assurance Manager

Document No.: DC-104_Issue_A
Date and Place of Issue: London, 12/09/2022

Page left Intentionally blank

Page left Intentionally blank

Page left Intentionally blank