

INSTRUCTION MANUAL

E2xB05 & E2xB10 Xenon Beacons

For use in Hazardous Locations

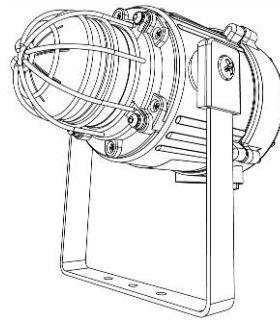

E2XB1X05
E2XB1X10

1) Product Table

Model	Nom. Voltage	Voltage Range	Operating rms Current
E2xB05DC012	12Vdc	10-14Vdc	520mA
E2xB05DC024	24Vdc	20-28Vdc	275mA
E2xB05DC048	48Vdc	42-54Vdc	145mA
E2xB05AC115	115Vac	Nominal +/- 10%	80mA
E2xB05AC230	230Vac	Nominal +/- 10%	30mA
E2xB10DC024	24Vdc	20-28Vdc	560mA
E2xB10DC048	48Vdc	42-54Vdc	260mA
E2xB10AC115	115Vac	Nominal +/- 10%	185mA
E2xB10AC230	230Vac	Nominal +/- 10%	107mA

The current levels shown above are for the worst-case input voltage resulting in max. current.

Table 1: Electrical Ratings.

Ensure the system power supply is capable of providing the maximum current required for all units. Review associated cable size, length and quantity of units on each circuit.

2) Warnings



- DO NOT OPEN WHEN AN EXPLOSIVE ATMOSPHERE IS PRESENT
- DO NOT OPEN WHEN ENERGISED
- POTENTIAL ELECTROSTATIC CHARGING HAZARD - CLEAN ONLY WITH A DAMP CLOTH
- HIGH VOLTAGE SHOCK HAZARD. WAIT 5 MINUTES AFTER REMOVING POWER BEFORE OPENING THE ENCLOSURE

Avertissement:

- NE PAS OUVRIR UN PRESENCE D'ATMOSPHERE EXPLOSIVE
- NE PAS OUVRIR ENERGIE
- DANGER POTENTIEL CHARGE ÉLECTROSTATIQUE - NETTOYER UNIQUEMENT AVEC UN CHIFFON HUMIDE
- HAUT TENSION, RISK DE CHOC. ATTENDEZ 5 MINUTES APRES AVOIR DEBRANCHE L'ALIMENTATION AVANT D'OUVRIR LA BOITIER

3) Rating & Marking Information

3.1. ATEX / IECEx / UKEx certification

Standards	
EN IEC 60079-0:2018 / IEC60079-0:2017 (Ed 7): Explosive Atmospheres - Equipment. General Requirements	
EN IEC 60079-7:2015 +A1:2018 / IEC 60079-7:2018 (Ed. 5.1): Explosive Atmospheres - Equipment Protection by Increased Safety "e"	
EN 60079-31:2014 / IEC 60079-31:2013 (Ed 2): Explosive Atmospheres - Equipment Dust Ignition Protection by Enclosure "t"	
Ratings	
E2XB05 :	Ex ec IIC T3 Gc Ta -20°C to +40°C Ex ec IIC T2 Gc Ta -20°C to +55°C Ex tc IIIC 85°C Dc Ta -20°C to +40°C Ex tc IIIC 100°C Dc Ta -20°C to +55°C
E2XB10 :	Ex ec IIC T2 Gc Ta -20°C to +55°C Ex tc IIIC 105°C Dc Ta -20°C to +40°C Ex tc IIIC 120°C Dc Ta -20°C to +55°C

Certificate No. DEMKO 06ATEX 0421554X
IECEX ULD 14.0012X
UL21UKEX2135X

ATEX Mark, Equipment Group and Category:

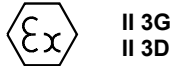

CE Marking



UKCA Marking



3.3. NEC & CEC Ratings

NEC & CEC Class / Division Ratings for US / Canada

Standards	
UL 121201-2021 (Ed. 9) CAN/CSA C22.2 No. 213-17 (Ed. 3)	
Ratings	
E2XB05:	Class I, Div 2, ABCD T2D Ta -20°C to +55°C Class I, Div 2, ABCD T3 Ta -20°C to +40°C Class II, Div 2, FG T5 Ta -20°C to +55°C Class II, Div 2, FG T6 Ta -20°C to +40°C Class III, Div 1&2 Ta -20°C to +55°C
E2XB10:	Class I, Div 2, ABCD T2A Ta -20°C to +55°C Class II, Div 2, FG T4A Ta -20°C to +55°C Class II, Div 2, FG T5 Ta -20°C to +40°C Class III, Div 1&2 Ta -20°C to +55°C
Installation must be carried out in compliance with the National Electric Code / Canadian Electric Code	

NEC Class / Zone ratings US

Standards	
UL 60079-0 (Ed. 7): Explosive Atmospheres - part 0: Equipment - General Requirements UL 60079-7 (Ed. 5): Explosive Atmospheres - Equipment Protection by Increased Safety "e" UL 60079-31 (Ed. 2) Explosive Atmospheres - Equipment Dust Ignition Protection by Enclosure "t"	
Ratings	
E2XB05:	Class I Zone 2 AEx ec IIC T3 Gc Ta -20°C to +40°C Class I Zone 2 AEx ec IIC T2 Gc Ta -20°C to +55°C Zone 22 AEx tc IIIB 85°C Dc Ta -20°C to +40°C Zone 22 AEx tc IIIB 100°C Dc Ta -20°C to +55°C
E2XB10:	Class I Zone 2 AEx ec IIC T2 Gc Ta -20°C to +55°C Zone 22 AEx tc IIIB 105°C Dc Ta -20°C to +40°C Zone 22 AEx tc IIIB 120°C Dc Ta -20°C to +55°C
Installation must be carried out in compliance with the National Electric Code.	

CEC Class / Zone ratings Canada

Standards	
CAN/CSA C22.2 No. 60079-0 (Ed. 4) 02/2019 Explosive Atmospheres - Part 0: Equipment - General Requirements CAN/CSA C22.2 No. 60079-7 (Ed. 2) Explosive Atmospheres - Equipment Protection by Increased Safety "e" CAN/CSA C22.2 No. 60079-31 (Ed. 2) Explosive Atmospheres - Equipment Dust Ignition Protection by Enclosure "t"	
Rating	
E2XB05:	Class I Zone 2 Ex ec IIC T3 Gc Ta -20°C to +40°C Class I Zone 2 Ex ec IIC T2 Gc Ta -20°C to +55°C Zone 22 Ex tc IIIC 85°C Dc Ta -20°C to +40°C Zone 22 Ex tc IIIC 100°C Dc Ta -20°C to +55°C
E2XB10:	Ex ec IIC T2 Gc Ta -20°C to +55°C Ex tc IIIC 105°C Dc Ta -20°C to +40°C Ex tc IIIC 120°C Dc Ta -20°C to +55°C
Installation must be carried out in compliance with the Canadian Electric Code	

4) Zones, Gas Groups, Category and Temperature Classification

When connected to an approved system the E2X alarm horn may be installed in:

Area Classification	
Zone 2	Explosive gas air mixture not likely to occur in normal operation, and if it does, it will only exist for a short time.
Zone 22	Explosive dust air mixture not likely to occur in normal operation, and if it does, it will only exist for a short time.
Gas Groupings	
Group IIA	Propane
Group IIB	Ethylene
Group IIC	Hydrogen and Acetylene
Temperature Classification for Gas Applications	
T1	450°C
T2	300°C
T3	200°C
T4	135°C
Dust Groupings (ATEX / IECEx / UKEX only)	
Group IIIA	Combustible Flyings
Group IIIB	Non-conductive Dust
Group IIIC	Conductive Dust
Maximum Surface Temperature for Dust Applications (ATEX / IECEx / UKEX only)	
E2XB05:	85°C (Up to 40°C Ambient Only) 100°C

E2XB10:	105°C (Up to 40°C Ambient Only) 120°C
Equipment Category	
3G / 3D	
Equipment Level Protection	
Gc, Dc	
Ambient Temperature Range	
-40°C to +55°C	
IP Rating	
IP6X to EN/IEC60079-0 IP66 to EN60529 To maintain the ingress protection rating, the two off cable entries must be fitted with suitably rated, certified cable entry and/or blanking devices during installation.	
Type Rating	
Per UL50E / NEMA250: 4 / 4X / 3R / 13	

The E2x beacon should be secured to any flat surface using the three 7mm fixing holes on the stainless steel U shaped mounting bracket. See Figure 1. The required angle can be achieved by loosening the two large bracket screws in the side of the unit, which allow adjustment of the beacon in steps of 18°. On completion of the installation the two large bracket adjustment screws on the side of the unit must be fully tightened to ensure that the unit cannot move in service.

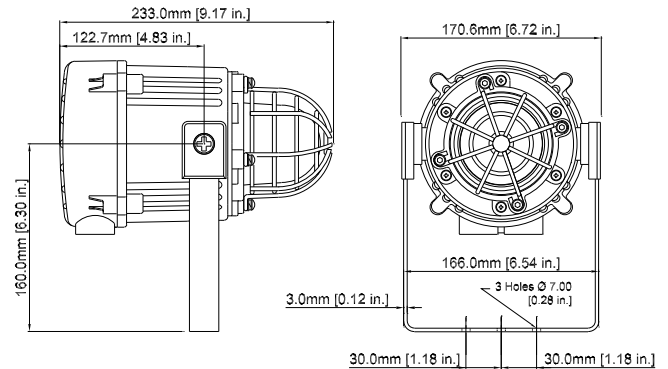

Fig. 1 Fixing Location for Beacon

Installation must be carried out in compliance with the latest issue of the following standards:

- EN60079-14 / IEC60079-14: Explosive atmospheres - Electrical installations design, selection and erection
- EN60079-10-1 / IEC60079-10-1: Explosive atmospheres - Classification of areas. Explosive gas atmospheres
- EN60079-10-2 / IEC60079-10-2: Explosive atmospheres - Classification of areas. Explosive dust atmospheres

5) Special Conditions of Use

When used for a Group III application, the surface of the enclosure may store electrostatic charge and become a source of ignition in applications with a low relative humidity <~30% relative humidity where the surface is relatively free of surface contamination such as dirt, dust, or oil.

Guidance on protection against the risk of ignition due to electrostatic discharge can be found in EN TR50404 and IEC TR60079-32.

End user shall adhere to the manufacturer's installation and instruction when performing housekeeping to avoid the potential for hazardous electrostatic charges during cleaning, by using a damp cloth.

To maintain the ingress protection rating and mode of protection, the cable entries must be fitted with suitably rated, certified cable entry and/or blanking devices during installation.

The equipment incorporates metal parts isolated from earth, having capacitance values exceeding the limits permitted in the standards of certification. Mounting bracket – 10.33pF; Lens guard – 12.33pF.

6) Product Mounting and Access

6.1. Location and Mounting

The location of the beacon should be made with due regard to the area over which the warning signal must be visible. They should only be fixed to services that can carry the weight of the unit.

6.2. Access to the Enclosure



Warning – High voltage may be present, risk of electric shock. DO NOT open when energised, disconnect power before opening.



Warning – Hot surfaces. External surfaces and internal components may be hot after operation, take care when handling the equipment.

To access the enclosure, remove the four M4 posi pan head screws, M4 spring and plain washers and withdraw the cover.

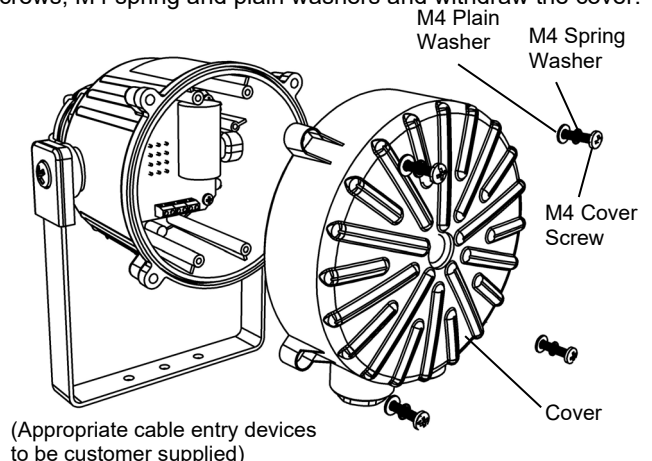

Fig. 2 Accessing the Enclosure.

To replace cover, check that the 'O' ring seal is in place. Carefully push the cover in place. Insert and tighten down M4 screws, spring and plain washers in the order shown above and tighten down.

7. Selection of Cable. Cable Glands, Blanking Elements & Adapters

When selecting the cable size, consideration must be given to the input current that each unit draws (see Table 1), the number of sounders on the line and the length of the cable runs. The cable size selected must have the necessary capacity to provide the input current to all of the sounders connected to the line.

The dual entries can be ordered with one of the following options:

- 2-off M20 x 1.5 thread
- 2-off ½" NPT thread
- 1-off M20 x 1.5 & 1-off ½" NPT thread

To maintain the ingress protection rating and mode of protection, the cable entries must be fitted with suitably rated, certified cable entry and/or blanking devices during installation.

For ambient temperatures over +40°C the cable entry temperature may exceed +70°C or the cable branching temperature may exceed +80°C. Therefore suitable heat resisting cables and cable glands must be used as per table below

Ambient Temp.	40°C	45°C	50°C	55°C
Min. Rating of cables and cable glands	90°C	95°C	100°C	105°C

If a high IP (Ingress Protection) rating is required then a suitable sealing washer must be fitted under the cable glands or blanking plugs.

For use in explosive dust atmospheres, a minimum ingress protection rating of IP6X must be maintained.

For use in explosive gas atmospheres, a minimum ingress protection rating of IP54 must be maintained.

8. Cable Connections

Electrical connections are to be made into the terminal blocks on the PCBA located in the enclosure. See section 5 of this manual for access to the enclosure.

Wires having a cross sectional area between 0.5 mm² to 2.5mm² can be connected to each terminal way. If an input and output wire is required the 2-off Live/Neutral or +/- terminals can be used. If fitting 2-off wires to one terminal way the sum of the 2-off wires must be a maximum cross sectional area of 2.5mm². Strip wires to 8mm. Wires may also be fitted using ferrules. Terminal screws need to be tightened down with a tightening torque of 0.56 Nm / 5 Lb-in. When connecting wires to the terminals great care should be taken to dress the wires so that when the cover is inserted into the chamber the wires do not exert excess pressure on the terminal blocks. This is particularly important when using cables with large cross sectional areas such as 2.5mm².

9. AC Wiring

3-off 2-way terminal blocks are provided on the AC beacon for power. There are 2-off Live, 2-off Neutral and 2-off Earth terminals in total.

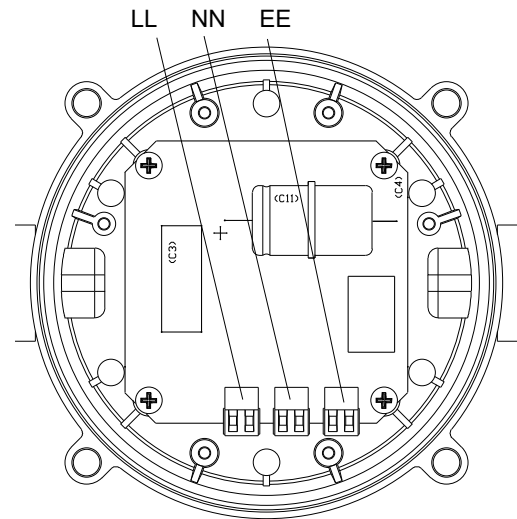

Fig. 4 E2xB05/E2xB10 AC Terminals

Refer to schematic document D209-06-201 for further detail on terminal connections.

10. DC Wiring

3-off 2-way terminal blocks are provided on the AC beacon for power. There are 2-off +ve, 2-off -ve and 2-off Earth terminals in total.

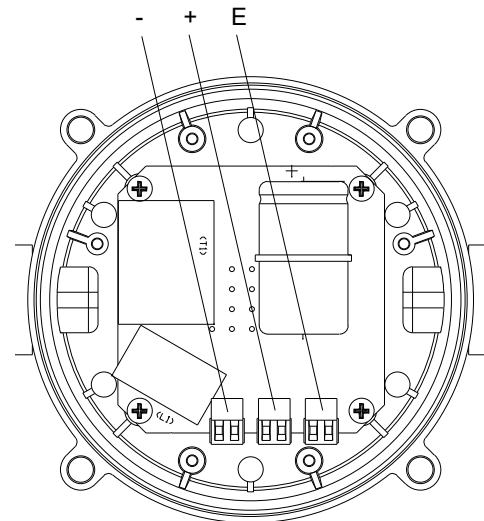

Fig. 6 E2xB05/E2xB10 DC Terminals

For further detail, refer to schematic document D209-06-201.

10.1 Line Monitoring

On E2xB05/E2xB10 DC units, DC reverse line monitoring can be used if required. All DC beacons have a blocking diode fitted in their supply input lines. An end of line monitoring resistor can be connected across the +ve and -ve terminals. If an end of line resistor is used it must have the following values:

	Min. Resistance	Min. Power
24V DC	3.9KΩ	0.5W
	1KΩ	2W
48V DC	15KΩ	0.5W
	3.9KΩ	2W

The resistor must be connected directly across the +ve and -ve terminals as shown in the following drawing. Form the resistor legs as shown in Fig. 8a, remove the +ve and -ve terminal plugs and fit the resistor across the two terminal plugs before refitting them to the PCBA as shown in Fig. 8b. A spacing of at least 1/16" (1.58mm) must be provided through air and over surfaces between uninsulated live parts.

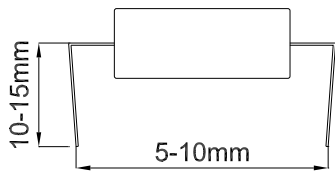

Fig. 8a End of Line Resistor Forming

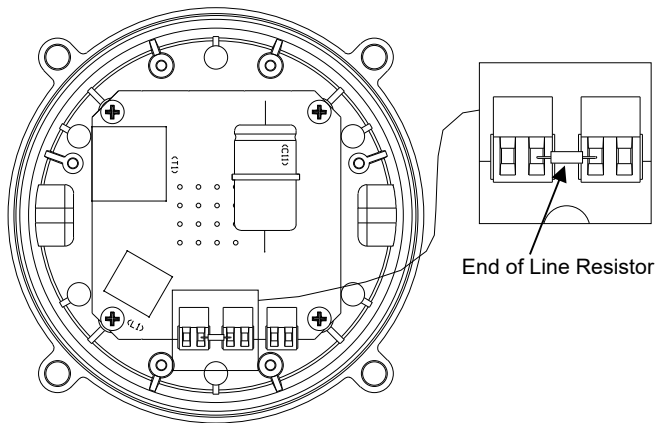

Fig. 8b End of Line Resistor Placement

Fit the wire guard back onto the housing, over the new lens cover aligning the fixing holes of the guard, lens cover and housing. Refit the fixings to hold into place, the fixings MUST be fitted in the order shown above.

12. Maintenance, Overhaul & Repair

Maintenance, repair and overhaul of the equipment should only be carried out by suitably qualified personnel in accordance with the current relevant standards:

EN60079-19	Explosive atmospheres - Equipment repair, overhaul and reclamation
IEC60079-19	
EN 60079-17	Explosive atmospheres - Electrical installations inspection and maintenance
IEC60079-17	

To avoid a possible ELECTROSTATIC CHARGE the unit must only be cleaned with a damp cloth.

Units must not be opened while an explosive atmosphere is present.

If opening the unit during maintenance operations a clean environment must be maintained and any dust layer removed prior to opening the unit.

11. Interchangeable & Spare Parts



Warning – Hot surfaces. External surfaces and internal components may be hot after operation, take care when handling the equipment.

The Beacon lens cover is interchangeable, contact E2S Ltd for a replacement lens cover available in various colours.

To change the lens cover, unscrew the 4-off M5 Cap screws, spring and flat washers using a 4mm Allen Key. Remove the wire guard and replace the old lens cover with the new lens cover.

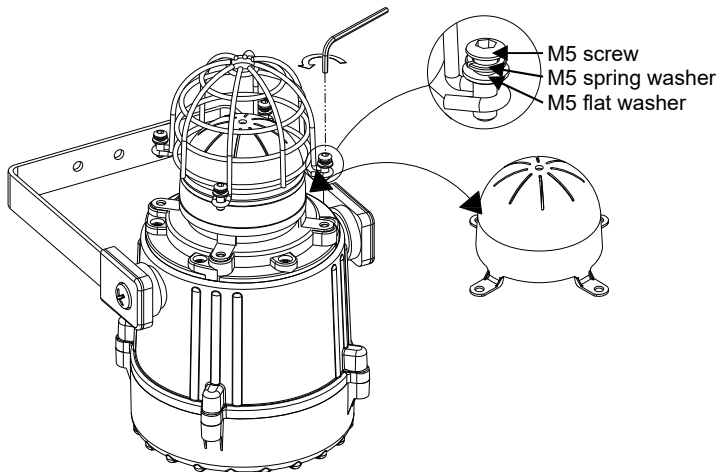

Fig. 9 Replacement of beacon lens cover

OPTIONAL LINE MONITORING RESISTOR, CUSTOMER SUPPLIED,
 REQUIRED MINIMUM VALUES:
 24VDC : 1KΩ MIN, 2W MIN OR 3K9Ω MIN, 0.5W MIN
 48VDC : 3.9KΩ MIN, 2W MIN OR 15KΩ MIN, 0.5W MIN

ISSUE	MOD No.	REASON - INITIAL - DATE
A		INTRODUCTION RSR - 05/08/2020
B		FORMAT UPDATED DH - 17/05/2022

DC XENON E2XB05 / B10 UNITS

AC XENON E2XB05 / B10 UNITS

Line Monitoring

Power: Live & Neutral

Power: +ve & -ve

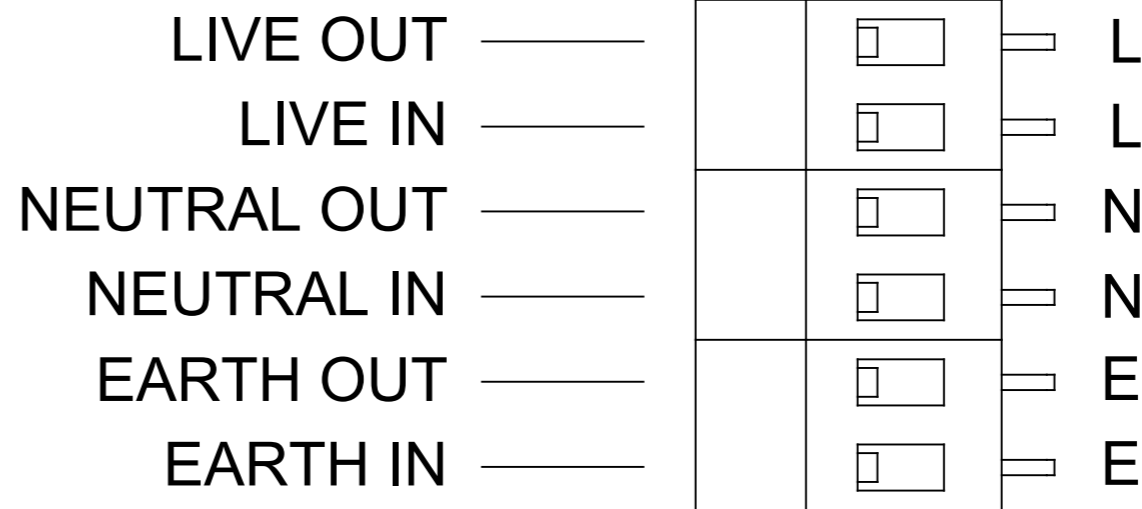
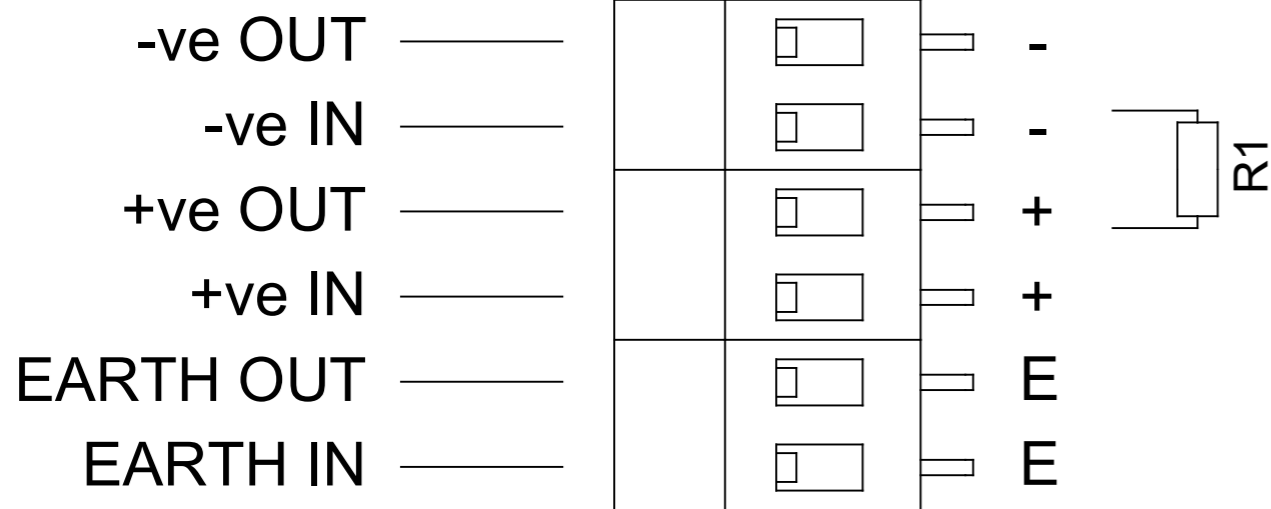
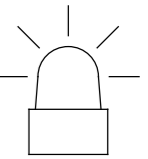
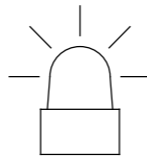

DRAWING TO BS8888:2000
 GEOMETRIC TOLERANCES TO ISO1101:1983
 LINEAR DIMENSIONAL TOLS
 ANGULAR DIMENSIONAL TOLS

DRAWN R.S.RAIT DATE 05/08/2020

SURFACE FINISH WEIGHT (Kg)

CHECKED R.N.POTTS DATE 05/08/2020

MATERIAL

APPROVED R.N.POTTS DATE 05/08/2020

ALTERNATIVE MATERIAL

THIS DRAWING AND ANY INFORMATION OR DESCRIPTIVE
 MATTER THEREIN IS COMMUNICATED IN CONFIDENCE AND
 IS THE COPYRIGHT PROPERTY OF EUROPEAN SAFETY
 SYSTEMS LTD. NEITHER THE WHOLE OR ANY EXTRACT MAY
 BE DISCLOSED, LOANED, COPIED OR USED FOR
 MANUFACTURING OR TENDERING PURPOSES WITHOUT THEIR
 WRITTEN CONSENT.

© EUROPEAN SAFETY SYSTEMS LTD.
 AS PER LATEST DATE OF ISSUE SHOWN ABOVE



EUROPEAN SAFETY SYSTEMS LTD
 IMPRESS HOUSE
 MANSELL ROAD
 ACTON
 LONDON W3 7QH
 WWW.E2S.COM

ALL DIMENSIONS IN MM
 IF IN DOUBT, ASK -
 DO NOT SCALE

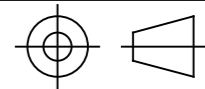

A3

TITLE E2xB05 / E2xB10 XENON
 BEACON WIRING DIAGRAMS

SCALE SHEET DRAWING NUMBER
 NTS 1 OF 1 D209-06-201

Ex N

EU Declaration of Conformity



Manufacturer: European Safety Systems Ltd.
Impress House, Mansell Road, Acton
London, W3 7QH
United Kingdom

Authorised Representative: E2S Warnsignaltechnik UG
Charlottenstrasse 45-51
72764 Reutlingen
Germany

Equipment Type: E2xS1, E2xS2
E2xB05, E2xB10, E2xBL2
E2xC1X05, E2xC1LD2,
E2xL15, E2xL25

Directive 2014/34/EU: Equipment and Protective Systems for use in Potentially Explosive Atmospheres (ATEX)

Notified Body for EU type Examination (Module B):	UL International Demko A/S Notified Body No.: 0539 Borupvang 5A, 2750 Ballerup, Denmark
EU-type Examination Certificate (Module B):	DEMKO 06 ATEX 0421554X
Notified Body for Quality Assurance Notification / Conformity to EU-type based on quality assurance of the production process (Module D):	Sira Certification Service Notified Body No.: 2813 CSA Group Netherlands B.V, Utrechtseweg 310, 6812 AR, Arnhem, Netherlands
Quality Assurance Notification (Module D):	SIRA 05 ATEX M342
Provisions fulfilled by the equipment:	II 3G Ex ec IIC T4/T3/T2 Gc II 3D Ex tc IIIC 85°C...120°C Dc IP6X Dust Protection to EN60079-0 / EN60079-31
Standards applied:	EN IEC 60079-0:2018 EN IEC 60079-7:2015 +A1:2018 EN 60079-31:2014

Directive 2014/30/EU: Electromagnetic Compatibility Directive (EMC)

Standards applied:	EN 61000-6-1:2007 EN 61000-6-2:2005 EN 61000-6-3:2007 / A1:2011 / AC: 2012 EN 61000-6-4:2007 / A1: 2011
--------------------	--

Directive 2014/35/EU: Low Voltage Directive (LVD)

Standards applied:	EN 60947-1:2007 + A2:2014
--------------------	---------------------------

Directive 2011/65/EU: Restriction of the use of certain hazardous substances in electrical and electronic equipment (RoHS)

The product and all the components contained within it are in accordance with the restriction of the use of hazardous substances in electrical and electronic equipment, including amendment by Directive 2015/863/EU.

Regulation (EC) 1907/2006: Registration, Evaluation, Authorisation and Restriction of Chemicals (REACH)

The product and all the components contained within it are free from substances of very high concern.

Other Standards and Regulations

EN 60529:1992+A2:2013 - Degrees of protection provided by enclosures (IP code) – enclosure rated IP66/IP67

EU Declaration of Conformity



On behalf of European Safety Systems Ltd., I declare that, on the date the equipment accompanied by this declaration is placed on the market, the equipment conforms with all technical and regulatory requirements of the above listed directives, regulations and standards.

This Declaration is issued under the sole responsibility of the manufacturer.

A handwritten signature in black ink, appearing to read 'Martin Streetz'.

Martin Streetz
Quality Assurance Manager

Document No.: DC-062_Issue_I
Date and Place of Issue: London, 22/08/2022



UKCA Declaration of Conformity



Manufacturer: European Safety Systems Ltd.
Impress House, Mansell Road, Acton
London, W3 7QH
United Kingdom

Equipment Type: E2xS1, E2xS2
E2xB05, E2xB10, E2xBL2
E2xC1X05, E2xC1LD2,
E2xL15, E2xL25

Directive UKSI 2016:1107 (as amended by UKSI 2019:696) – Schedule 3A, Part 1 : Product or Protective System Intended for use in Potentially Explosive Atmospheres (UKCA)

Notified Body for UK type Examination (Module B):	UL International (UK) Ltd Notified Body No.: 0843 Unit 1-3 Horizon Kingsland Business Park, Wade Road, Basingstoke, Hampshire RG24 8AH UK
UK-type Examination Certificate (Module B):	UL21UKEX2135X
Notified Body for Quality Assurance Notification / Conformity to EU-type based on quality assurance of the production process (Module D):	Sira Certification Service Notified Body No.: 0518 Rake Lane, Eccleston, Chester CH4 9JN, UK
Quality Assurance Notification (Module D):	CSAE 22UKQAN0046
Provisions fulfilled by the equipment:	II 3G Ex ec IIC T4/T3/T2 Gc II 3D Ex tc IIIC 85°C...120°C Dc IP6X Dust Protection to EN60079-0 / EN60079-31
Standards applied:	EN IEC 60079-0:2018 EN IEC 60079-7:2015 +A1:2018 EN 60079-31:2014

Directive 2014/30/EU: Electromagnetic Compatibility Directive (EMC)

Standards applied:	EN 61000-6-1:2007 EN 61000-6-2:2005 EN 61000-6-3:2007 / A1:2011 / AC: 2012 EN 61000-6-4:2007 / A1: 2011
--------------------	--

Directive 2014/35/EU: Low Voltage Directive (LVD)

Standards applied:	EN 60947-1:2007 + A2:2014
--------------------	---------------------------

Directive 2011/65/EU: Restriction of the use of certain hazardous substances in electrical and electronic equipment (RoHS)

The product and all the components contained within it are in accordance with the restriction of the use of hazardous substances in electrical and electronic equipment, including amendment by Directive 2015/863/EU.

Regulation (EC) 1907/2006: Registration, Evaluation, Authorisation and Restriction of Chemicals (REACH)

The product and all the components contained within it are free from substances of very high concern.

Other Standards and Regulations

EN 60529:1992+A2:2013 - Degrees of protection provided by enclosures (IP code) – enclosure rated IP66/IP67



UKCA Declaration of Conformity



On behalf of European Safety Systems Ltd., I declare that, on the date the equipment accompanied by this declaration is placed on the market, the equipment conforms with all technical and regulatory requirements of the above listed directives, regulations and standards.

This Declaration is issued under the sole responsibility of the manufacturer.

Martin Streetz
Quality Assurance Manager

Document No.: DC-103_Issue_A
Date and Place of Issue: London, 22/08/2022