

INSTRUCTION MANUAL

D2XC2XH1 & D2XC2XH2 UL1971 Alarm Horn and Xenon Beacon for use in Hazardous Locations

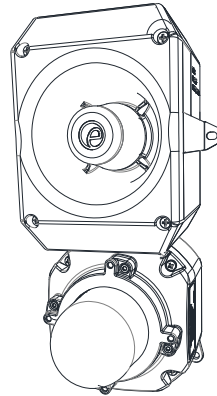

D2XC2XH1
D2XC2XH2

1) Product Table

Model	Nominal Voltage	Beacon Current	Sounder Current
D2xC2XH1DC024	20-28Vdc	296mA	313mA
D2xC2XH2DC048	48Vdc	145mA	181mA

For detailed max and surge current ratings of the device please see Section 14.

Table 1: Electrical Ratings

2) Warnings



- DO NOT OPEN WHEN AN EXPLOSIVE ATMOSPHERE IS PRESENT
- DO NOT OPEN WHEN ENERGISED
- POTENTIAL ELECTROSTATIC CHARGING HAZARD - CLEAN ONLY WITH A DAMP CLOTH
- HIGH VOLTAGE SHOCK HAZARD. WAIT 5 MINUTES AFTER REMOVING POWER BEFORE OPENING THE ENCLOSURE

Avertissement:

- NE PAS OUVRIR UN PRESENCE D'ATMOSPHERE EXPLOSIVE
- NE PAS OUVRIR ENERGIE
- DANGER POTENTIEL CHARGE ÉLECTROSTATIQUE - NETTOYER UNIQUEMENT AVEC UN CHIFFON HUMIDE
- HAUT TENSION, RISK DE CHOC. ATTENDEZ 5 MINUTES APRES AVOIR DEBRANCHE L'ALIMENTATION AVANT D'OUVRIR LA BOITIER

3) Rating & Marking Information

3.1. Public Mode Fire Alarm Ratings

The D2xC2XH1 and D2xC2XH2 are certified for use as public mode audible and visual alarm devices in accordance with UL1971 / UL1638 & UL464.

See fire instructions D211-00-651-IS-SC-UL

3.2. ATEX / IECEx / UKEx certification

Standards	
EN IEC 60079-0:2018 / IEC60079-0:2017 (Ed 7): Explosive Atmospheres - Equipment. General Requirements	
EN IEC 60079-7:2015 +A1:2018 / IEC 60079-7:2018 (Ed. 5.1): Explosive Atmospheres - Equipment Protection by Increased Safety "e"	
EN 60079-31:2014 / IEC 60079-31:2013 (Ed 2): Explosive Atmospheres - Equipment Dust Ignition Protection by Enclosure "t"	
Ratings	
D2xC2XH1	Ex ec IIC T3 Gc Ta -40°C to +50°C Ex tc IIIC T75°C Dc Ta -40°C to +50°C
D2xC2XH2	Ex ec IIC T2 Gc Ta -40°C to +50°C Ex tc IIIC T85°C Dc Ta -40°C to +50°C

Certificate No. DEMKO 14 ATEX 4786493904X
IECEx ULD 14.0004X
UL21UKEX2131X

ATEX Mark, Equipment Group and Category:



II 3G
II 3D

CE Marking



UKCA Marking



3.3. NEC & CEC Ratings

NEC & CEC Class / Division Ratings for US / Canada

Standards	
UL 121201-2021 (Ed. 9) CAN/CSA C22.2 No. 213-17 (Ed. 3)	
Ratings	
D2xC2XH1	Class I Div 2 ABCD T3 Ta -40°C to +50°C Class II Div 2 FG T6 Ta -40°C to +50°C Class III Div 1&2 Ta -40°C to +50°C
D2xC2XH2	Class I Div 2 ABCD T2A Ta -40°C to +50°C Class II Div 2 FG T6 Ta -40°C to +50°C Class III Div 1&2 Ta -40°C to +50°C
Installation must be carried out in compliance with the National Electric Code / Canadian Electric Code	

NEC Class / Zone ratings US

Standards	
UL 60079-0 (Ed. 7): Explosive Atmospheres - part 0: Equipment - General Requirements UL 60079-7 (Ed. 5): Explosive Atmospheres - Equipment Protection by Increased Safety "e" UL 60079-31 (Ed. 2) Explosive Atmospheres - Equipment Dust Ignition Protection by Enclosure "t"	
Ratings	
D2xC2XH1	Class I Zone 2 AEx ec IIC T3 Gc Ta -40°C to +50°C Zone 22 AEx tc IIIB T75°C Dc Ta -40°C to +50°C
D2xC2XH2	Class I Zone 2 AEx ec IIC T2 Gc Ta -40°C to +50°C Zone 22 AEx tc IIIB T85°C Dc Ta -40°C to +50°C
Installation must be carried out in compliance with the National Electric Code.	

CEC Class / Zone ratings Canada

Standards	
CAN/CSA C22.2 No. 60079-0 (Ed. 4) 02/2019 Explosive Atmospheres - Part 0: Equipment - General Requirements CAN/CSA C22.2 No. 60079-7 (Ed. 2) Explosive Atmospheres - Equipment Protection by Increased Safety "e" CAN/CSA C22.2 No. 60079-31 (Ed. 2) Explosive Atmospheres - Equipment Dust Ignition Protection by Enclosure "t"	
Rating	
D2xC2XH1	Ex ec IIC T3 Gc X Ta -40°C to +50°C Ex tc IIIC T75°C Dc Ta -40°C to +50°C
D2xC2XH2	Ex ec IIC T2 Gc X Ta -40°C to +50°C Ex tc IIIC T85°C Dc Ta -40°C to +50°C

Installation must be carried out in compliance with the Canadian Electric Code

4) Zones, Gas Group, Category and Temperature Classification

Area Classification	
Zone 2	Explosive gas air mixture not likely to occur in normal operation, and if it does, it will only exist for a short time.
Zone 22	Explosive dust air mixture not likely to occur in normal operation, and if it does, it will only exist for a short time.
Gas Groupings	
Group IIA	Propane
Group IIB	Ethylene
Group IIC	Hydrogen and Acetylene
Temperature Classification for Gas Applications	
T1	450°C
T2	300°C
T3	200°C (D2xC2XH1 only)
Dust Groupings (ATEX / IECEx / UKEX only)	
Group IIIA	Combustible Flyings
Group IIIB	Non-conductive Dust
Group IIIC	Conductive Dust
Maximum Surface Temperature for Dust Applications (ATEX / IECEx / UKEX only)	
D2xC2XH1	75°C
D2xC2XH2	85°C
Equipment Category	
3G / 3D	
Equipment Level Protection	
Gc, Dc	
Ambient Temperature Range	
-40°C to +50°C	
IP Rating	
IP6X to EN/IEC60079-0 IP66 to EN60529 To maintain the ingress protection rating, the two off cable entries must be fitted with suitably rated, certified cable entry and/or blanking devices during installation.	
Type Rating	
Per UL50E / NEMA250: 4 / 4X / 3R / 13	

Installation must be carried out in compliance with the latest issue of the following standards:
EN60079-14 / IEC60079-14: Explosive atmospheres - Electrical installations design, selection and erection
EN60079-10-1 / IEC60079-10-1: Explosive atmospheres - Classification of areas. Explosive gas atmospheres
EN60079-10-2 / IEC60079-10-2: Explosive atmospheres - Classification of areas. Explosive dust atmospheres

5) Special Conditions for Safe Use

Special Condition for safe Use as stated on the Type Examination Certificate DEMKO 14 ATEX 4786493904X / CoC IECEX ULD 14.0004X / UL21UKEX2131X:

When used for a Group III application, the surface of the enclosure may store electrostatic charge and become a source of ignition in applications with a low relative humidity <~30% relative humidity where the surface is relatively free of surface contamination such as dirt, dust, or oil.

Guidance on protection against the risk of ignition due to electrostatic discharge can be found in EN TR50404 and IEC TR60079-32.

End user shall adhere to the manufacturer's installation and instruction when performing housekeeping to avoid the potential for hazardous electrostatic charges during cleaning, by using a damp cloth.

To maintain the ingress protection rating and mode of protection, the cable entries must be fitted with suitably rated, certified cable entry and/or blanking devices during installation.

Use heat resistant cables and glands (rated 95°C)

6) Product Mounting and Access

6.1. Location and Mounting

The location of the combined alarm horn and beacon should be made with due regard to the area over which the warning signal must be visible and audible. It should only be fixed to services that can carry the weight of the unit.

D2xC2 Combined unit should be fitted to a flat surface via the two 9.7 x 6.7mm, 147mm pitch fixing holes in the mounting feet of the sounder section and the two 6.9mm, 116mm pitch fixing holes in the feet of the base.

The equipment is not to be mounted with the horn facing

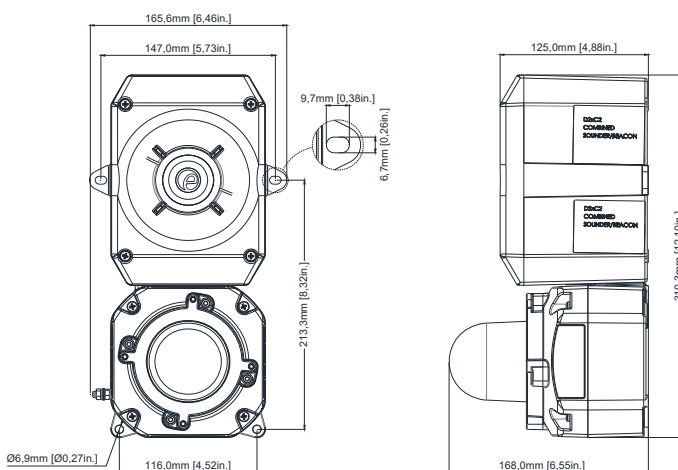

upwards.

Fig. 1 Fixing locations.

6.2. Access to the Enclosure



Warning – High voltage may be present, risk of electric shock. DO NOT open when energised, disconnect power before opening.

Warning – Hot surfaces. External surfaces and internal components may be hot after operation, take care when handling the equipment.

To access the enclosure, loosen the four M4 posi pan head screws and withdraw the cover.

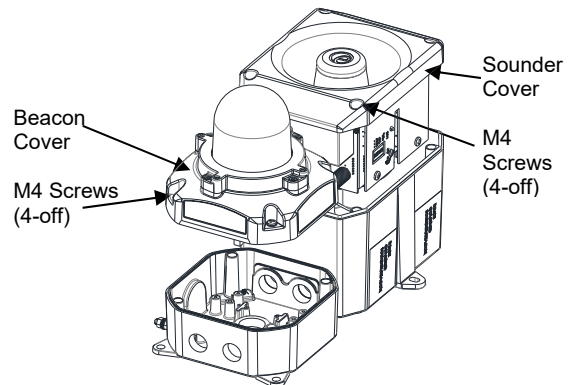

Fig. 2 Accessing Enclosures.

To replace cover, check that the 'O' ring seal is in place. Carefully push the cover in place. Insert M4 screws with fiber washers and tighten to 3Nm torque.

7) Selection of Cable, Cable Glands, Blanking Elements & Adapters

When selecting the cable size, consideration must be given to the input current that each unit draws (see section 15), the number of beacons on the line and the length of the cable runs. The cable size selected must have the necessary capacity to provide the input current to all of the sounders connected to the line.

When selecting the cable size consideration must be given to the voltage drop over the length of the cable run to ensure the min. input voltage at the point of use (voltage range, see section 15)

The voltage drop depends on:

- The total current draw of the devices installed on this cable run
- The wire size and total length of the cable run, determining the total resistance of this cable run
- The minimum output voltage supplied by the power supply

The voltage drop and input voltage at the point of use can be calculated as follows:

$$\text{Total Wire resistance} = \text{Wire resistance} / 1000\text{ft} \times \text{length of cable run} \times 2$$

(length of cable run needs to be multiplied by two to account for two wires going to and from the unit)

$$\text{Total current draw} = \text{Current draw per unit} \times \text{number of units}$$

$$\text{Voltage Drop} = \text{Total current draw} \times \text{Total wire resistance}$$

Minimum output of power supply =
Min. voltage at point of use + voltage drop

For ambient temperatures over +45°C the cable entry temperature may exceed +70°C. Therefore suitable heat resisting cables and cable glands rated to min. 95°C must be used:

If a high IP (Ingress Protection) rating is required then a suitable sealing washer must be fitted under the cable glands or blanking plugs.

For use in explosive dust atmospheres, a minimum ingress protection rating of IP6X must be maintained.

For use in explosive gas atmospheres, a minimum ingress protection rating of IP54 must be maintained.

NPT plugs should be greased before insertion.

8) Cable Connections

Electrical connections are to be made into the terminal blocks on the PCBA located in the enclosure. See section 6 of this manual for access to the enclosure.

Wires having a cross sectional area between 0.5 mm² to 2.5mm² can be connected to each terminal way. If an input and output wire is required the 2-off Live/Neutral or +/- terminals can be used. If fitting 2-off wires to one terminal way the sum of the 2-off wires must be a maximum cross sectional area of 2.5mm². Strip wires to 8mm. Wires may also be fitted using ferrules. Terminal screws need to be tightened down with a tightening torque of 0.56 Nm / 5 Lb-in. When connecting wires to the terminals great care should be taken to dress the wires so that when the cover is inserted into the chamber the wires do not exert excess pressure on the terminal blocks. This is particularly important when using cables with large cross sectional areas such as 2.5mm².

9) Wiring

The Strobe is powered via factory installed wires connected to the alarm horn. The wires connecting the alarm horn and strobe can be removed if the user wishes to power the strobe separately.

For further wiring schematics refer to document D211-06-651

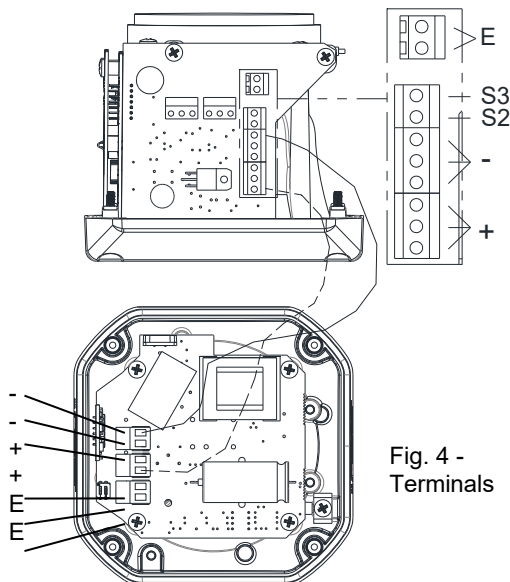

10) Earthing

The unit has both internal and external earth points, (please see fig 2 & fig 4).

Internal earthing connections should be made to the internal earth terminal on the PCBA, (please see fig 4). The earth conductor should be at least equal in size and rating to the incoming power conductors. The internal earth bonding wire connects the PCBA earth terminal to the internal earth terminal in the enclosure back box.

External earth connections should be made to the M5 earth stud on the beacon housing, using a ring crimp terminal to secure the earth conductor to the earth stud. The external earth conductor should be at least 4mm² in size. The external earth crimp ring should be located between the two M5 plain washers provided and securely locked down with the M5 spring washer and M5 nut.

11) End Of Line Monitoring

On Dx2XH1 & D2x2XH2 units, dc reverse line monitoring can be used if required. All units have a blocking diode fitted in their supply input lines. An end of line monitoring resistor can be connected across the +ve and -ve terminals. If an end of line resistor is used it must have the following values:-

Min. Resistance	Min. Power
3.9KΩ	0.5W
1KΩ	2W

The resistor must be connected directly across the +ve and -ve terminals of the sounder board only, as shown in the following drawing. Whilst keeping its leads as short as possible, a spacing of at least 1/16 inch (1.58mm) must be provided through air and over surfaces between uninsulated live parts. The resistor must be connected directly across the +ve and -ve terminals as shown in the following drawing. Form the resistor legs as shown in Fig. 5, remove the +ve and -ve terminal plugs and fit the resistor across the two terminal plugs before refitting them to the PCBA as shown in Fig. 6a & 6b. A spacing of at least 1/16" (1.58mm) must be provided through air and over surfaces between uninsulated live parts.

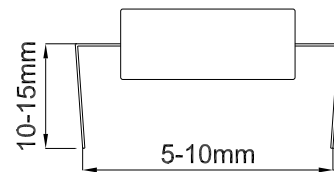

Fig. 5 End of Line Resistor Forming

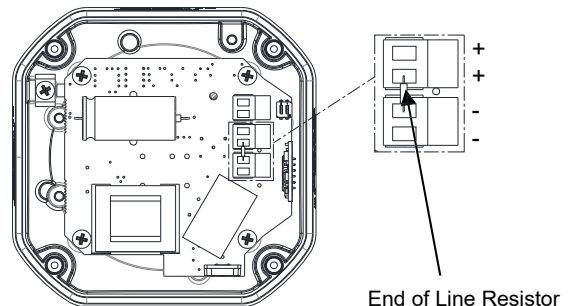

Fig. 6a End of Line Resistor Placement - Beacon

13) Maintenance, Overhaul & Repair

Maintenance, repair and overhaul of the equipment should only be carried out by suitably qualified personnel in accordance with the current relevant standards:

EN60079-19	Explosive atmospheres - Equipment repair, overhaul and reclamation
IEC60079-19	
EN 60079-17	Explosive atmospheres - Electrical installations inspection and maintenance
IEC60079-17	

To avoid a possible ELECTROSTATIC CHARGE the unit must only be cleaned with a damp cloth.

Units must not be opened while an explosive atmosphere is present.

If opening the unit during maintenance operations a clean environment must be maintained and any dust layer removed prior to opening the unit.

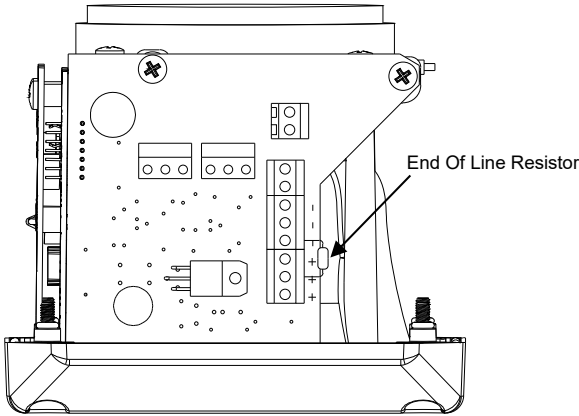

Fig. 6b End of Line Resistor Placement – Sounder

12) Settings

12.1 Beacon DIP Switch

Please note that the D2xC2XH1 & D2xC2XH2 beacon PCBAs have a DIP Switch that is NOT customer configurable. This should only ever be set to '00'.

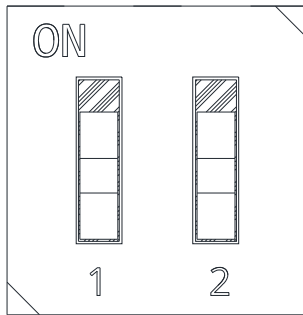

Fig. 7 DIP Switch setting '00'

12.2 Volume Control

The alarm horn output level of the D2xC2 unit can be set by adjusting the volume control potentiometer (see Fig 9). For maximum output, set the potentiometer fully clockwise.

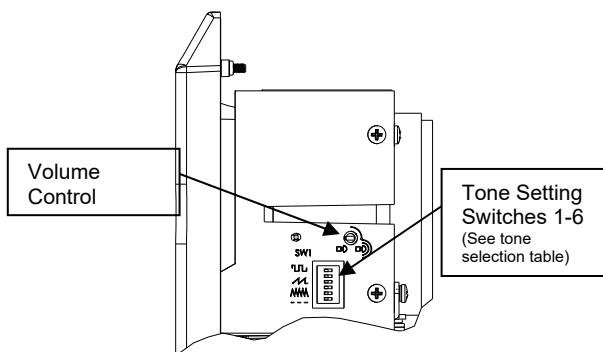

Fig. 9 Location of field controls

12.3 Tone Selection

The D2xC2 alarm horns have 64 different tones. The tones are selected by operation of the tone setting DIP switches (see Fig. 9) on the PCB. The alarm horns can also be switched to sound the second, third and fourth stage alarm tones. The tone table shows the switch positions for the 64 tone and which tones are available for the second, third and fourth stages.

14) Electrical Ratings

14.1 Operating current Consumption

Table 6 – Electrical Ratings

Model	Nom. Voltage	Voltage Range	Flash Rate Setting	Max. operating current##
D2xC2XH1DC024	24Vdc	20-28Vdc	1Hz (60fpm)	0.449A
D2xC2XH2DC024	24Vdc	20-28Vdc	1Hz (60fpm)	0.785A

For Public Mode Fire Alarm use

max. rms current at worst-case voltage in voltage range.

15) Tone Table

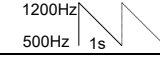
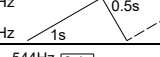
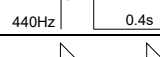
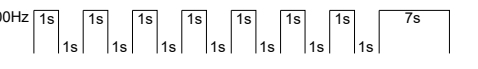
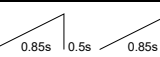
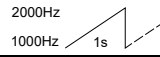
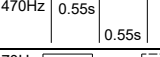
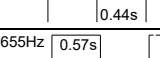
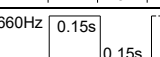
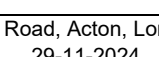
Tone Selection – To select the required first stage tone set the tone switches 1 to 6 (see Fig 9) to the tone setting shown in the table below. The table also shows which 2 nd , 3 rd and 4 th stage tones are available for use with the selected first stage tone if more than one tone output stage is required.						
Stage 1 Tone No	Tone Description	Tone Visual	Switch Settings 1 2 3 4 5 6	Stage 2 Tone (S2)	Stage 3 Tone (S3)	Stage 4 Tone (S2 + S3)
1	1000Hz PFEER Toxic Gas	1000Hz _____	0 0 0 0 0 0	3	2	44
2	1200/500Hz @ 1Hz DIN / PFEER P.T.A.P.		1 0 0 0 0 0	1	3	44
3	1000Hz @ 0.5Hz(1s on, 1s off) PFEER Gen. Alarm		0 1 0 0 0 0	1	2	44
4	1.4KHz-1.6KHz 1s, 1.6KHz-1.4KHz 0.5s NF C 48-265		1 1 0 0 0 0	44	24	1
5	544Hz(100mS)/440Hz (400mS) NF S 32-001		0 0 1 0 0 0	52	19	1
6	1500/500Hz - (0.5s on , 0.5s off) x3 + 1s gap AS4428		1 0 1 0 0 0	7	44	1
7	500-1500Hz Sweeping 2 sec on 1 sec off AS4428		0 1 1 0 0 0	6	44	1
8	500/1200Hz @ 0.26Hz(3.3s on, 0.5s off) Netherlands - NEN 2575		1 1 1 0 0 0	44	24	35
9	1000Hz (1s on, 1s off)x7 + (7s on, 1s off) IMO Code 1a		0 0 0 1 0 0	18	34	1
10	1000Hz (1s on, 1s off)x7 + (7s on, 1s off) IMO Code 1a		1 0 0 1 0 0	21	34	1
11	420Hz(0.5s on, 0.5s off)x3 + 1s gap ISO 8201 Temporal Pattern		0 1 0 1 0 0	44	1	8
12	1000Hz(0.5s on, 0.5s off)x3 + 1s gap ISO 8201 Temporal Pattern		1 1 0 1 0 0	44	1	8
13	422/775Hz - (0.85 on, 0.5 off) x3 + 1s gap NFPA - Temporal Coded		0 0 1 1 0 0	44	1	8
14	1000/2000Hz @ 1Hz Singapore		1 0 1 1 0 0	23	3	35
15	300Hz Continuous	300Hz _____	0 1 1 1 0 0	44	24	35
16	440Hz Continuous	440Hz _____	1 1 1 1 0 0	44	24	35
17	470Hz Continuous	470Hz _____	0 0 0 0 1 0	44	24	35
18	500Hz Continuous IMO code 2 (Low)	500Hz _____	1 0 0 0 1 0	44	24	35
19	554Hz Continuous	554Hz _____	0 1 0 0 1 0	64	24	35
20	660Hz Continuous	660Hz _____	1 1 0 0 1 0	44	24	35
21	800Hz IMO code 2 (High)	800Hz _____	0 0 1 0 1 0	44	24	35
22	1200Hz Continuous	1200Hz _____	1 0 1 0 1 0	44	24	35
23	2000Hz Continuous	2000Hz _____	0 1 1 0 1 0	15	3	35
24	2400Hz Continuous	2400Hz _____	1 1 1 0 1 0	48	20	35
25	440 @0.83Hz (50 cycles/minute) Intermittent		0 0 0 1 1 0	1	44	8
26	470 @0.9Hz - 1.1s Intermittent		1 0 0 1 1 0	1	44	8
27	470Hz @5Hz - (5 cycles/second) Intermittent		0 1 0 1 1 0	1	44	8
28	544Hz @ 1.14Hz - 0.875s Intermittent		1 1 0 1 1 0	44	24	8
29	655Hz @ 0.875Hz Intermittent		0 0 1 1 1 0	1	44	8
30	660Hz @0.28Hz - 1.8sec on, 1.8sec off Intermittent		1 0 1 1 1 0	44	24	8
31	660Hz @3.34Hz - 150mS on, 150mS off Intermittent		0 1 1 1 1 0	30	24	8

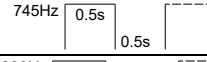
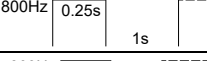
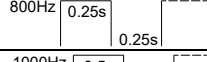
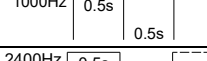
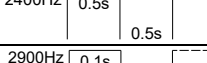
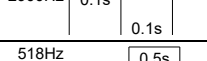
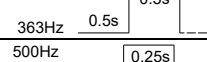
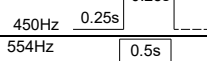
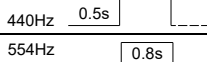
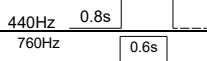
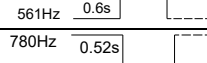
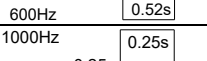
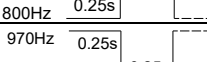
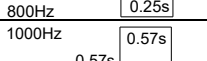
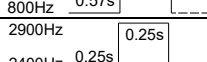
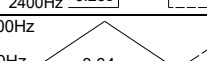
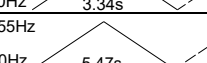
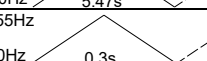
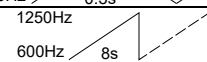
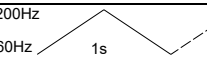
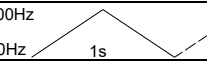
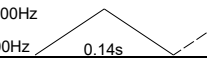
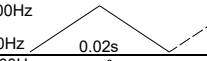
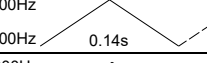
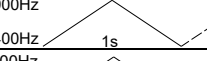
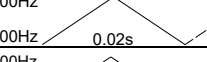
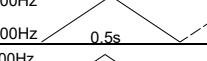
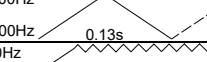
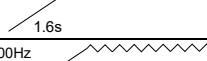
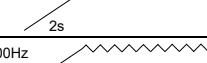
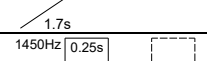
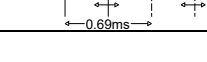
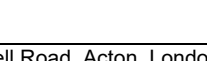
32	745Hz @ 1Hz Intermittent		1 1 1 1 1 0	44	24	8
33	800Hz - 0.25sec on, 1 sec off Intermittent		0 0 0 0 0 1	53	24	8
34	800Hz @ 2Hz IMO code 3.a (High) Intermittent		1 0 0 0 0 1	56	24	8
35	1000Hz @ 1Hz Intermittent		0 1 0 0 0 1	44	24	8
36	2400Hz @ 1Hz Intermittent		1 1 0 0 0 1	21	24	8
37	2900Hz @ 5Hz Intermittent		0 0 1 0 0 1	53	24	8
38	363/518Hz @ 1Hz Alternating		1 0 1 0 0 1	1	8	19
39	450/500Hz @ 2Hz Alternating		0 1 1 0 0 1	1	8	19
40	554/440Hz @ 1Hz Alternating		1 1 1 0 0 1	44	24	19
41	554/440Hz @ 0.625Hz Alternating		0 0 0 1 0 1	1	8	19
42	561/760Hz @ 0.83Hz (50 cycles/minute) Alternating		1 0 0 1 0 1	1	8	19
43	780/600Hz @ 0.96Hz Alternating		0 1 0 1 0 1	1	8	19
44	800/1000Hz @ 2Hz Alternating		1 1 0 1 0 1	5	24	19
45	970/800Hz @ 2Hz Alternating		0 0 1 1 0 1	1	8	19
46	800/1000Hz @ 0.875Hz Alternating		1 0 1 1 0 1	53	24	19
47	2400/2900Hz @ 2Hz Alternating		0 1 1 1 0 1	57	24	19
48	500/1200Hz @ 0.3Hz Sweeping		1 1 1 1 0 1	44	24	12
49	560/1055Hz @ 0.18Hz Sweeping		0 0 0 0 1 1	44	24	12
50	560/1055Hz @ 3.3Hz Sweeping		1 0 0 0 1 1	44	24	12
51	600/1250Hz @ 0.125Hz Sweeping		0 1 0 0 1 1	44	24	12
52	660/1200Hz @ 1Hz Sweeping		1 1 0 0 1 1	64	24	12
53	800/1000Hz @ 1Hz Sweeping		0 0 1 0 1 1	56	24	12
54	800/1000Hz @ 7Hz Sweeping		1 0 1 0 1 1	57	24	12
55	800/1000Hz @ 50Hz Sweeping		0 1 1 0 1 1	54	24	12
56	2400/2900Hz @ 7Hz Sweeping		1 1 1 0 1 1	57	24	12
57	2400/2900Hz @ 1Hz Sweeping		0 0 0 1 1 1	47	24	12
58	2400/2900Hz @ 50Hz Sweeping		1 0 0 1 1 1	54	24	12
59	2500/3000Hz @ 2Hz Sweeping		0 1 0 1 1 1	44	24	12
60	2500/3000Hz @ 7.7Hz Sweeping		1 1 0 1 1 1	44	24	12
61	800Hz Motor Siren		0 0 1 1 1 1	44	24	12
62	1200Hz Motor Siren		1 0 1 1 1 1	44	24	12
63	2400Hz Motor Siren		0 1 1 1 1 1	44	24	12
64	Simulated Bell		1 1 1 1 1 1	44	21	12

ISSUE	MOD No.	REASON - INITIAL - DATE
1		INTRODUCTION RSR 02-01-2020
2		NEW FORMAT DH 17-05-2022

OPTIONAL LINE MONITORING RESISTOR, CUSTOMER SUPPLIED,
REQUIRED MINIMUM VALUES:
24VDC : 1KΩ MIN, 2W MIN OR 3K9Ω MIN, 0.5W MIN
48VDC : 3.9KΩ MIN, 2W MIN OR 15KΩ MIN, 0.5W MIN

----- WIRING LINKING BEACON & SOUNDER
FACTORY FITTED

TO OPERATE SOUNDER AND BEACON
INDEPENDENTLY, REMOVE FACTORY
FITTED WIRES LINKING THE UNITS

DC D2XC2XH1/ XH2 UNITS

Line Monitoring

- Stage 1: Apply power to Sounder +ve & -ve
- Stage 2: Apply power to Sounder +ve & -ve. Connect Stage 2 to -ve
- Stage 3: Apply power to Sounder +ve & -ve. Connect Stage 3 to -ve
- Stage 4: Apply power to Sounder +ve & -ve. Connect Stage 2 and Stage 3 to -ve

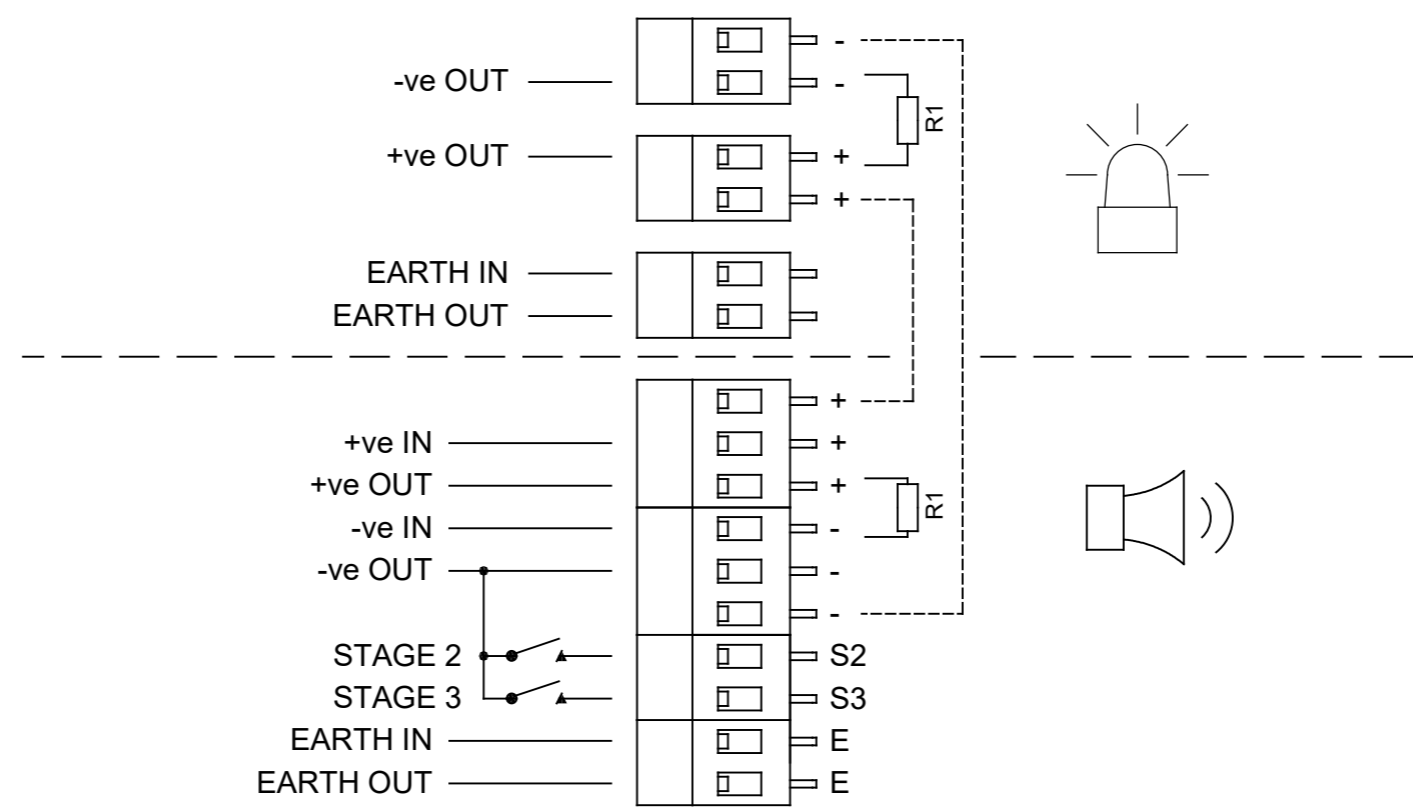

DRAWING TO BS8888:2000
GEOMETRIC TOLERANCES TO ISO1101:1983
LINEAR DIMENSIONAL TOLS +/-0.35mm
ANGULAR DIMENSIONAL TOLS +/-2 deg

DRAWN	DATE
R.S.RAIT	27-06-2019
CHECKED	DATE
B. ISARD	27-06-2019
APPROVED	DATE
R.N.POTTS	27-06-2019

SURFACE FINISH	WEIGHT (Kg)
MATERIAL	
ALTERNATIVE MATERIAL	

THIS DRAWING AND ANY INFORMATION OR DESCRIPTIVE
MATTER THEREIN IS COMMUNICATED IN CONFIDENCE AND IS
THE COPYRIGHT PROPERTY OF EUROPEAN SAFETY SYSTEMS
LTD. NEITHER THE WHOLE OR ANY EXTRACT MAY BE
DISCLOSED, LOANED, COPIED OR USED FOR MANUFACTURING
OR TENDERING PURPOSES WITHOUT THEIR WRITTEN
CONSENT.

© EUROPEAN SAFETY SYSTEMS LTD.
AS PER LATEST DATE OF ISSUE SHOWN ABOVE

e2s
warning signals

EUROPEAN SAFETY SYSTEMS LTD
IMPRESS HOUSE
MANSELL ROAD
ACTON
LONDON W3 7QH
WWW.E2S.COM

ALL DIMENSIONS IN MM IF IN DOUBT, ASK - DO NOT SCALE		
TITLE D2xC2XH1/D2XC2XH2 PUBLIC MODE FIRE COMBINED BEACON AND SOUNDER WIRING DIAGRAM		
SCALE NTS	SHEET 1 OF 1	DRAWING NUMBER D211-06-651

EU Declaration of Conformity



Manufacturer: European Safety Systems Ltd.
Impress House, Mansell Road, Acton
London, W3 7QH
United Kingdom

Authorised Representative: E2S Warnsignaltechnik UG
Charlottenstrasse 45-51
72764 Reutlingen
Germany

Equipment Type: D2xS1, D2xS2, D2xL1, D2xL2, D2xC1X05, D2xC1X10
D2xB1X05, D2xB1X10, D2xB1LD2, D2xB1XH1, D2xB1XH2, D2xB1LD3
D2xC2X05, D2xC2X10, D2xC2LD2, D2xC2XH1, D2xC2XH2, D2xC2LD3
D2xJ1

Directive 2014/34/EU: Equipment and Protective Systems for use in Potentially Explosive Atmospheres (ATEX)

Notified Body for EU type Examination (Module B):	UL International Demko A/S Notified Body No.: 0539 Borupvang 5A, 2750 Ballerup, Denmark
EU-type Examination Certificate (Module B):	DEMKO 14 ATEX 4786493904X
Notified Body for Quality Assurance Notification / Conformity to EU-type based on quality assurance of the production process (Module D):	Sira Certification Service Notified Body No.: 2813 CSA Group Netherlands B.V, Utrechtseweg 310, 6812 AR, Arnhem, Netherlands
Quality Assurance Notification (Module D):	SIRA 05 ATEX M342
Provisions fulfilled by the equipment:	II 3G Ex ec IIC T6/T5/T4A/T4/T3C/T3/T2/T1 Gc II 3D Ex tc IIIC T55/75/80/85/90/93/95/105/109/110/119°C Dc Ingress / Dust Protection to EN60079-0 / EN60079-31: IP66
Standards applied:	EN IEC 60079-0:2018 EN IEC 60079-7:2015 +A1:2018 EN 60079-31:2014

Directive 2014/30/EU: Electromagnetic Compatibility Directive (EMC)

Standards applied:	EN 61000-6-1:2007 EN 61000-6-2:2005 EN 61000-6-3:2007 / A1:2011 / AC: 2012 EN 61000-6-4:2007 / A1: 2011
--------------------	--

Directive 2011/65/EU: Restriction of the use of certain hazardous substances in electrical and electronic equipment (RoHS)

The product and all the components contained within it are in accordance with the restriction of the use of hazardous substances in electrical and electronic equipment, including amendment by Directive 2015/863/EU.

EU Declaration of Conformity



Regulation (EC) 1907/2006: Registration, Evaluation, Authorisation and Restriction of Chemicals (REACH)

The product and all the components contained within it are free from substances of very high concern.

Other Standards and Regulations

EN 60529:1992+A2:2013 - Degrees of protection provided by enclosures (IP code) – enclosure rated:

IP66 All units

IP66/67 D2xL1, D2xL2, D2xS2 only

On behalf of European Safety Systems Ltd., I declare that, on the date the equipment accompanied by this declaration is placed on the market, the equipment conforms with all technical and regulatory requirements of the above listed directives, regulations and standards.

This Declaration is issued under the sole responsibility of the manufacturer.

A handwritten signature in black ink, appearing to read 'Martin Streetz'.

Martin Streetz
Quality Assurance Manager

Document No.: DC-061_Issue_K
Date and Place of Issue: London, 04/12/2023



UKCA Declaration of Conformity



Manufacturer: European Safety Systems Ltd.
Impress House, Mansell Road, Acton
London, W3 7QH
United Kingdom

Equipment Type: D2xS1, D2xS2, D2xL1, D2xL2, D2xC1X05, D2xC1X10
D2xB1X05, D2xB1X10, D2xB1LD2, D2xB1XH1, D2xB1XH2, D2xB1LD3
D2xC2X05, D2xC2X10, D2xC2LD2, D2xC2XH1, D2xC2XH2, D2xC2LD3
D2xJ1

Directive UKSI 2016:1107 (as amended by UKSI 2019:696) – Schedule 3A, Part 1 : Product or Protective System Intended for use in Potentially Explosive Atmospheres (UKCA)

Notified Body for UK type Examination (Module B):	UL International (UK) Ltd Notified Body No.: 0843 Unit 1-3 Horizon Kingsland Business Park, Wade Road, Basingstoke, Hampshire RG24 8AH UK
UK-type Examination Certificate (Module B):	UL21UKEX2131X
Notified Body for Quality Assurance Notification / Conformity to EU-type based on quality assurance of the production process (Module D):	Sira Certification Service Notified Body No.: 0518 Rake Lane, Eccleston, Chester CH4 9JN, UK
Quality Assurance Notification (Module D):	CSAE 22UKQAN0046
Provisions fulfilled by the equipment:	II 3G Ex ec IIC T6/T5/T4A/T4/T3C/T3/T2/T1 Gc II 3D Ex tc IIIC T55/75/80/85/90/93/95/105/109/110/119°C Dc Ingress / Dust Protection to EN60079-0 / EN60079-31: IP66 All units
Standards applied:	EN IEC 60079-0:2018 EN IEC 60079-7:2015 +A1:2018 EN 60079-31:2014

Directive 2014/30/EU: Electromagnetic Compatibility Directive (EMC)

Standards applied:	EN 61000-6-1:2007 EN 61000-6-2:2005 EN 61000-6-3:2007 / A1:2011 / AC: 2012 EN 61000-6-4:2007 / A1: 2011
--------------------	--

Directive 2011/65/EU: Restriction of the use of certain hazardous substances in electrical and electronic equipment (RoHS)

The product and all the components contained within it are in accordance with the restriction of the use of hazardous substances in electrical and electronic equipment, including amendment by Directive 2015/863/EU.



UKCA Declaration of Conformity



Regulation (EC) 1907/2006: Registration, Evaluation, Authorisation and Restriction of Chemicals (REACH)

The product and all the components contained within it are free from substances of very high concern.

Other Standards and Regulations

EN 60529:1992+A2:2013 - Degrees of protection provided by enclosures (IP code) – enclosure rated:

IP66 All units

IP66/67 D2xL1, D2xL2, D2xS2 only

On behalf of European Safety Systems Ltd., I declare that, on the date the equipment accompanied by this declaration is placed on the market, the equipment conforms with all technical and regulatory requirements of the above listed directives, regulations and standards.

This Declaration is issued under the sole responsibility of the manufacturer.

Martin Streetz
Quality Assurance Manager

Document No.:
Date and Place of Issue:

DC-102_Issue_B
London, 04/12/2023